

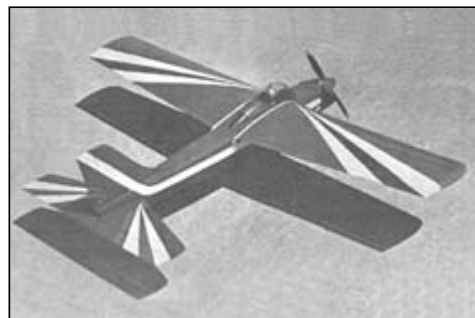

BUILDING AND FLYING INSTRUCTIONS

SIG CRAFTMAN'S KIT SIGRC39

The Kavalier was designed as a next-step airplane after a beginning flier has mastered basic R/C flying on the Sig Kadet. The special wing design was developed to aid the novice aileron pilot make smooth, well coordinated turns. Built-in washout (a decrease in wing incidence at the tip as compared to the wing root) helps prevent tip stalls and improves slow speed flight characteristics and landings. Special aileron horns provide for differential action ailerons, with less down movement and more up. On ailerons with equal up and down movement, the increase in drag caused by the lowered aileron is apt to cause an adverse yaw reaction, swinging the nose of the model opposite to the aileron roll direction. The combination of wash out and differential ailerons contribute to the easy handling qualities of the Kavalier.



A Note On Balsa Wood

We do our best to put as good a grade of balsa in our kits as the supply situation permits. The world-wide increase in demand for balsa has made it impossible to obtain as high an average quality as used to be the case and this situation is getting worse. Every piece of balsa supplied cannot be 100% perfect or kit prices would have to be greatly increased. Mineral stains or small knots do not seriously affect wood strength. Even with the very best grades of balsa, there is a natural tendency for some sticks or sheets to immediately bow upon being cut off from a perfectly square block because of built-in stresses. In most cases, these can be bowed back into alignment during building. True up the edges of bowed sheets by trimming, using a metal straightedge to cut against. Planking sheets, as used on the wing, need not be perfectly flat since they must be curved into place anyway during construction. The gluing of the plywood doublers and stringers to the fuselage sides while they are pinned to a flat surface should flatten out any warps in the side sheets.

Wood Sizes In The Kit

Sometimes, depending on the raw wood supply and sawing schedules, we may put a larger piece of planking wood in the kit. For example, you may get 2" wide wood for the wing trailing edge planking instead of 1-1/2" wide. This extra wood, cut off when planking, can be saved for some other use. In other cases, the wood may measure slightly larger than the dimension called for on the plan. We feel that it is best to have enough wood when fitting a part in place, so it will adequately fill the spot, instead of an "exact" size that might be not quite big enough, given the tendency of model components to "grow" as the parts are glued together.

Recommended Glues

The framework may be glued with either Sig-Bond resin type glue or Sig-Ment solvent type cement. In any joint involving plywood or hardwood, Sig-Bond is the best choice. Areas subjected to unusual strain, exposed to fuel or oil, or including metal pieces, should be epoxied with Sig Epoxy Glue or Sig Kwik-Set 5 minute type epoxy. Some specific pieces have other recommendations. You will find these in the directions concerning the part.

About The Building Sequence

The quickest and most efficient way to complete a model is to work on several pieces at the same time. While the glue is drying on one section you can start on or proceed with another part. Work can even go forward on several sections of the same assembly at the same time, such as the front and rear of the fuselage. We occasionally get suggestions that our instruction books should be in exact step-by-step building sequence. But this would result in many sentences starting, "While the glue is drying on the fuselage, move to the wing etc." and a lot of jumping back and forth between assemblies with no consistent pictorial progression. Also, a pre-selected building sequence by our choice might not suit your workshop space and time allotments. Therefore, we feel the present system of covering main assemblies in a unit works out best for the majority of kit builders. So keep in mind that the numbering sequence used in this book was chosen as the best way of explaining the building of each major assembly and is not intended to be followed in exact one-two-three fashion. Start on the wing at No. 1 and after performing a step or two, flip over to the next main heading of "FUSELAGE CONSTRUCTION" and do a step or two there, then over to "FIN ASSEMBLY" and so forth. You will, of course, arrive at points where you can go no farther until another component is available. For example, you need a completed and mounted wing before the front of the fuselage on top can be completed. The way to understand these relationships is to read the book completely and study the full size plan before beginning to work.

Some Rules To Follow

Cut all long pieces of balsa first, followed by medium lengths before cutting up any full-length strips into short pieces. Remove die-cut pieces from the sheets carefully. If difficulty is encountered, do not force the part from the sheet. Use a modeling knife to cut it free. Leave parts in the sheets until needed in construction.

A piece of Celotex-type wallboard makes a handy building board, into which pins can easily be pushed. Lay the building board on a table with a flat and untwisted top. Pins can be pushed through all pieces in the kit without any lasting damage. Don't be afraid to use plenty of pins when planking. The holes will fill up during sanding and dopping.

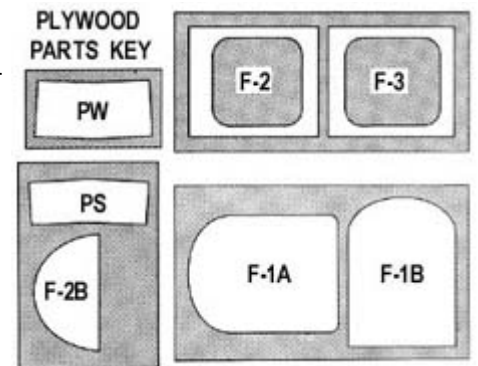

Wax paper should be used to protect the plan during building when the glue used is epoxy or an aliphatic resin glue such as Sig-Bond. If a model cement like Sig-Ment is preferred, use plastic wrap to protect the drawing. This type of glue can dissolve the wax, which will inhibit drying.

Be careful where you use a ball point pen for making marks. If not sanded off, these marks will bleed through many coats of dope and show on the finished model.

Any reference to right or left refers to right or left as if seated in the cockpit.

You Can't Get Along Without A Good Sanding Block

An indispensable tool for proper construction is a large sanding block, sized to take a full sheet of sand paper. Use several wood screws along one edge to hold the sheet in place. We recommend 80 grit Garnet paper for use on the block during general construction. You can switch to 100 grit for final finish just before covering

In addition to the large block, there are places where a smaller one is handy.

Also, a sandpaper "file" can be made by gluing sandpaper to a flat spruce stick for working in tight places. We have an especially handy extra long sanding block made from a 40 inch piece of aluminum channel with sandpaper glued to it that is particularly useful for jobs like lining up and beveling ribs prior to gluing the leading edge in place.

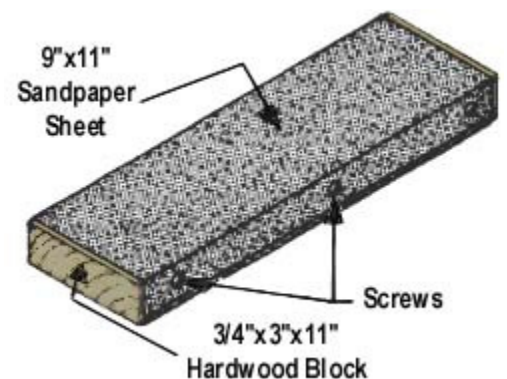

Cutting Out Printed Parts

A jig saw is best for this job. Cut just outside the lines, leaving all of the black line on the part. When fitting the part into place in the model, use the sanding block to bring the edges to an exact fit. If a modeling knife is used to cut out the parts, don't cut too close to the lines, leave some extra wood outside the line. True up and finish the edge with the sanding block.

About Printed Wood Parts

To answer a question we are sometimes asked - no, we do not print parts on wood to save money. It is actually more expensive to print the parts using a silk screen press than it is to run an equivalent sheet through our automatic feed die cutting machine. If we hand-sawed the parts it would be even more expensive and the labor cost would have to be added to the kit price. We believe that most modelers would rather cut their own out and save the cost. Since there are not many thick parts in our average kit, it really doesn't consume a lot of the total building time for the builder to do the parts.

WING CONSTRUCTION

1. After the ribs are removed from the die-cut sheets, pass the bottom of each rib over a sanding block to smooth and/or level point "X" with the rear jig tab. Only one or two passes should be required, but take care not to oversand. Ignore the other side of the spar hole from point "X", it will not touch the sanding block on the smaller ribs nor is it necessary for it to touch. (See Drawing 7 and Drawing 25).
2. Check the spar slots in each rib by putting the rib on the spar wood to make certain the slots are deep enough for point "X" to touch the building board. The slot should be wide enough so that the jig tab will rest easily on the building board without having to be forced down. Should the spar slots in the ribs need deepening or widening, file them open a bit with the sandpaper file.
3. Cut 8-3/8" off the end of each of the 4 pieces of 1/4"x1/2"x36" spar wood provided and glue the pieces to the remainder as center section spar doublers.

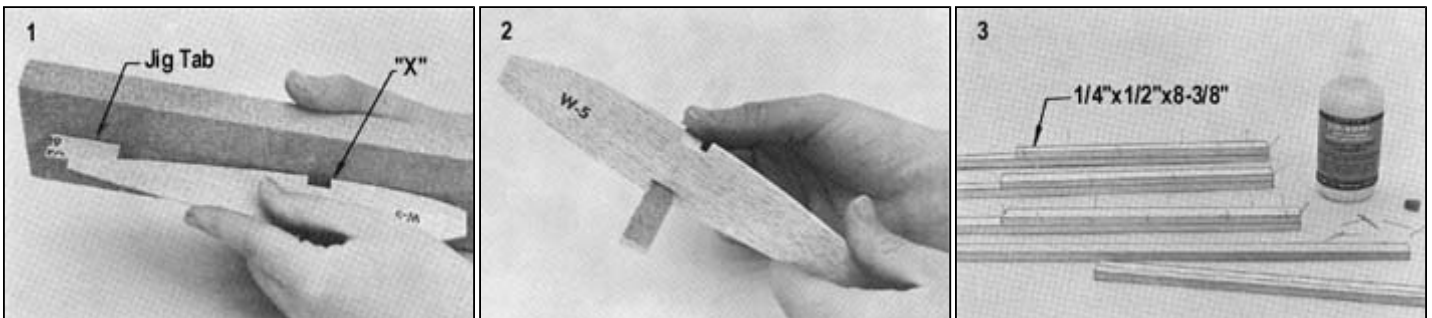

4. Pin two of the jigs in place on the plan. Do not glue them together at the center seam.
5. Glue and pin the ribs in place along the spar. Do not glue Ribs W-1 in place, just pin them. Use a small triangle to make certain the ribs are exactly vertical.
6. Hold the jig tabs firmly to the building board with "T" headed pins.

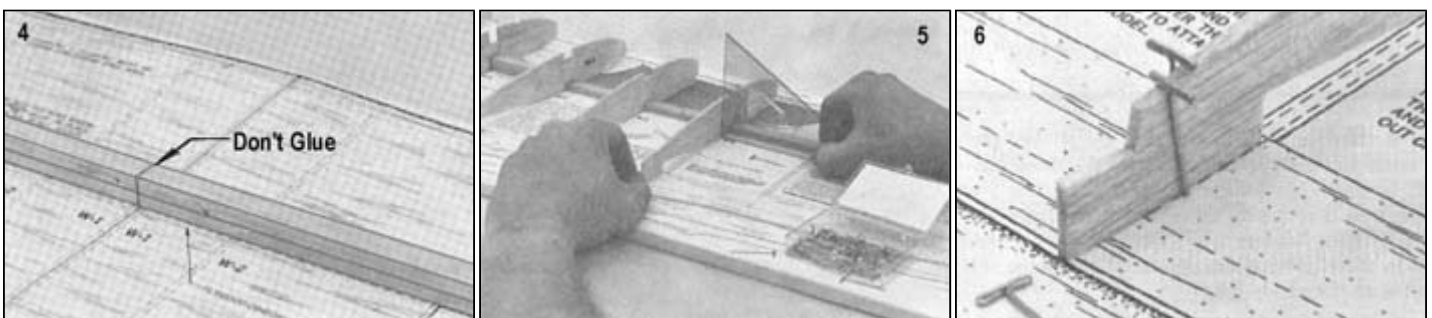

7. When all the ribs are in place, add the top spars. Do not glue them together at the center seam or to Ribs W-1.

8. The place to best check the accuracy of the wing layout is point "Z" as shown on the drawing below. Lay a straight edge along the ribs at "Z". If there are any noticeably high points, touch up these ribs with a sanding block. Do not oversand. Remember the old story of shortening the legs on a table to make it sit level - and the eventual result.
9. Check the trailing edge supports on the jig tabs with a straightedge and measure the backs of the ribs for correct dimension. Deepen any supports that are too high. Ignore any that are low, the trailing edge will bridge across them.

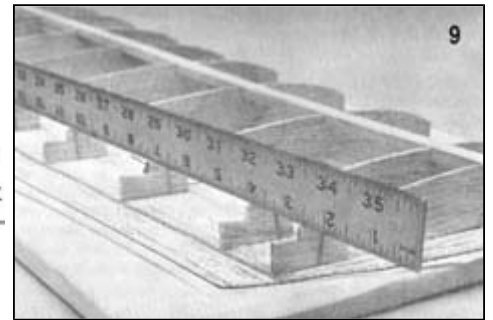
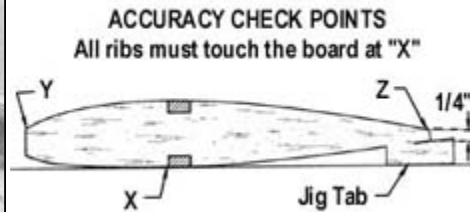
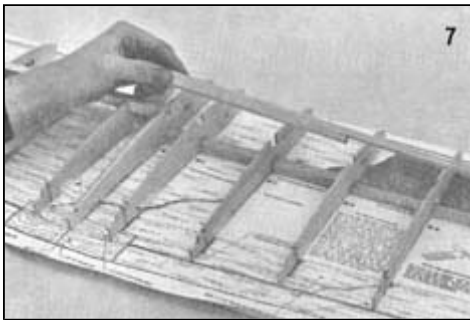

10. Use epoxy to glue the 1/4"x1/2" shaped trailing edge to the backs of the ribs only. Do not glue the trailing edge to the jig tab supports.
11. Pin the trailing edge in place on the supports until the glue sets.
12. Use a straightedge to cut the leading edge pieces from 3/16"x5/8"x36" strip wood. We don't pre-cut the leading edges because of the tendency of balsa strips to bow after being cut from a square block of wood because of internal stresses in the wood. By trimming them yourself you can cut off the bow. A small point, but one of a number we feel help insure construction of an accurate wing.

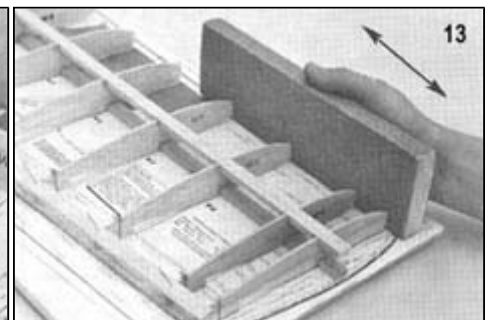
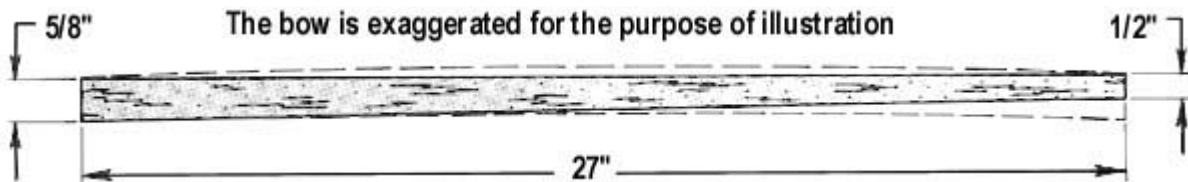

13. Bevel the fronts of the ribs with a sanding block so that they are all in line (check with a straightedge) and will fit snugly against the leading edge.

14. Lay the straightedge along point "Y" and touch up any extreme high spots.

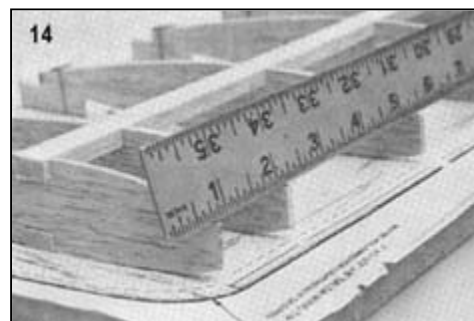

15. Pin and glue the leading edge piece in place.

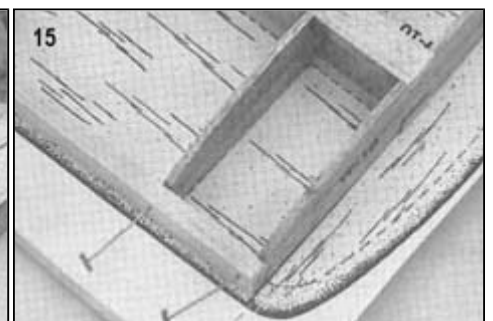

16. Touch up the trailing edge with the small block.

17. Touch up the ribs with the large block. Do not oversand.

18. Epoxy glue is recommended for applying the trailing edge planking for two reasons: First, when set, it will lock the trailing edge in the proper wash-out twist position. Secondly, it will have no tendency to bow or warp as such a large area application might do with water base glues. Photo shows an application of Kwik-Set glue with a Sig Throwaway Epoxy Brush. Work quickly, for Kwik-Set begins to harden in 4 minutes at normal room temperature.

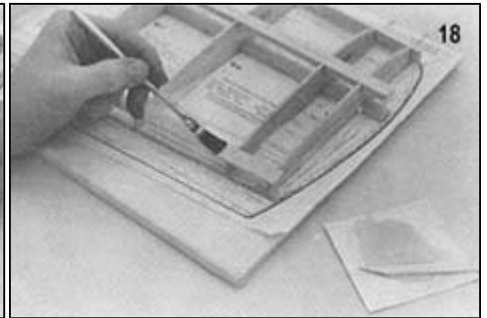
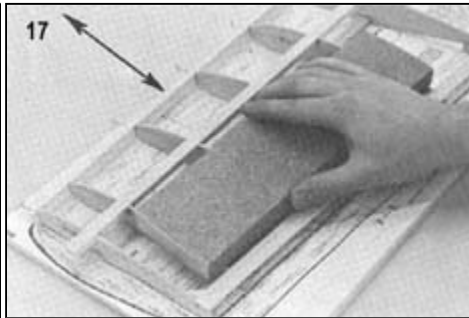
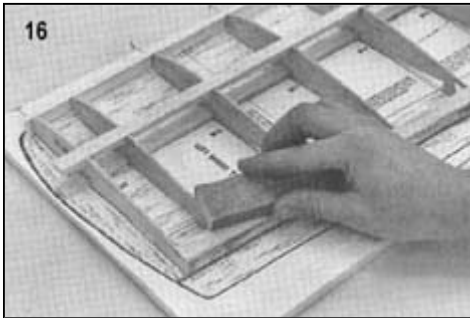

19. Pin the 1-1/2" trailing edge planking sheet in place.

20. Shave or carve the leading edge to rough contour shape, using a whittling knife or razor plane. Finish with a sanding block.

- 21.
- Remove one wing half from the board, leaving half there.
 - Push back Rib W-1 a bit to get it out of the way.
 - Using the dihedral gauge, mark and trim off the spars, leading edge and trailing edge for the angled dihedral joint.

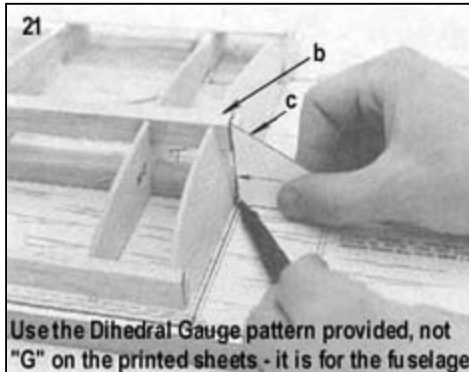
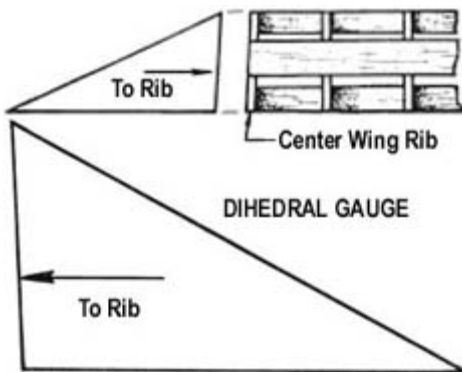
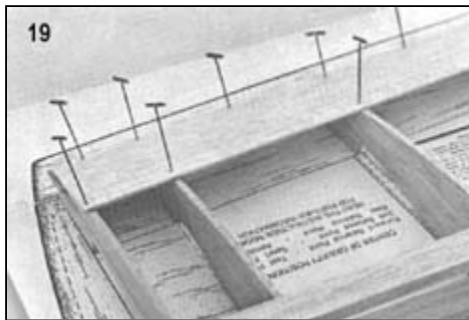

RIGHT! This is not the "STANDARD" method of wing construction, but there is a reason.

The most common method of assembling a built up wing involves gluing all of the top planking and cap strips on while the wing structure is still pinned to the board. But we noticed that this causes a certain amount of bowing because of the great difference between all of the parts glued to the top without anything on the bottom. Another wing put together in a different way showed no sign of this problem. So the recommended procedure shown in the photos may not be familiar but it will help to improve the accuracy of the special Kavalier wing design. You will find that the sequence shown does not require much extra effort on the part of the builder. On the other hand, if you prefer the standard method, it will produce a wing of acceptable tolerance, if not as good as the sequence pictured. (In this case, use non-water base glue.)

IMPORTANT: Repeat the steps above on the other half of the wing, so that it will be angled the same amount.

22. Pin a 2-3/4" high scrap block to the board at the end of the wing plan. Draw vertical lines with a 90 degree triangle from the spar location to the top of the block.

23. Return the wing half that had been previously removed from the board, this time with the spar resting in the marked location on the block. Glue the halves together at the center joint with epoxy. Have "wet" joints, using plenty of glue. We like to punch angled holes in the joining surfaces with a pointed wire and then work the glue into them. When set, these "nails" make for a stronger joint. During the joining of the halves, be sure and glue the two W-1 ribs to each other as well as to the spars and leading and trailing edges.

24. Take the wing off the board and remove the jig tabs Cut from the front toward the die cut slit at the back. Sand the trailing edge and the ribs even.

25. Repeat step 20 on the bottom of the leading edge.

26. As the ribs get smaller toward the tip, the spar pro- the ribs. trudes down below the rib at the back of the spar hole. Sand the spar to the rib contour.

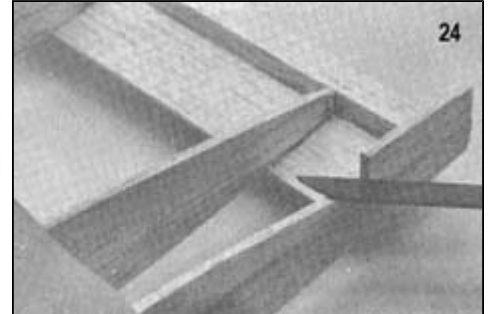
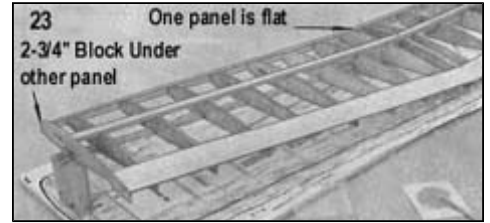

27. Add 1/4"x1" fill in blocks behind the center section leading edge as shown in the accompanying drawing.

28. Pin and glue a piece of 3/32"x4" planking (cut from a 36" long sheet) to the top of the spar on half of the wing.

29. Immediately turn the wing over and glue the bottom sheet in place. The reason this is done is to keep any bowing action of the wet glue balanced out, helping keep the wing true.

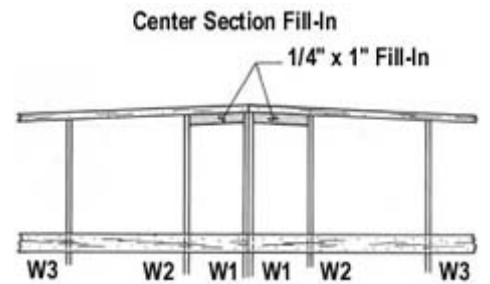

30. Apply Sig-Bond to the ribs and leading edge. Use a glue gun or a slim, pointed balsa stick to reach back along the ribs.

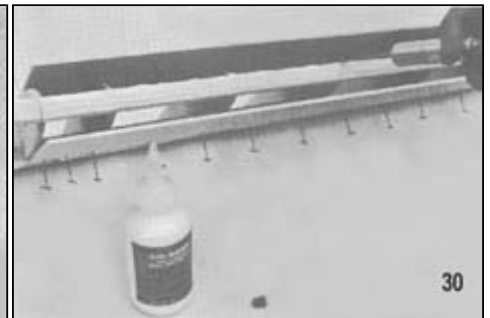
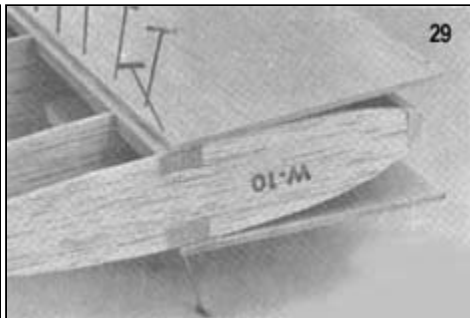
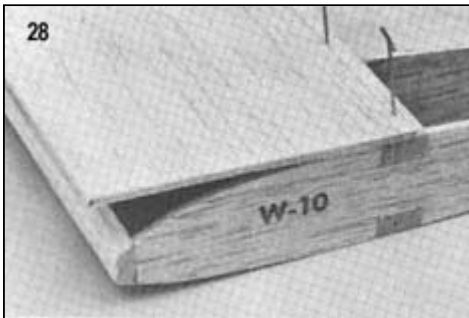

31. Pin the sheet down to the ribs and leading edge. Use plenty of pins to insure that the planking is held securely against the structure. Don't wet the planking unless it is necessary to get it to bow to the shape of the wing. If it will bend to shape, do it dry. As soon as one sheet is pinned down, repeat the process on the opposite sheet.

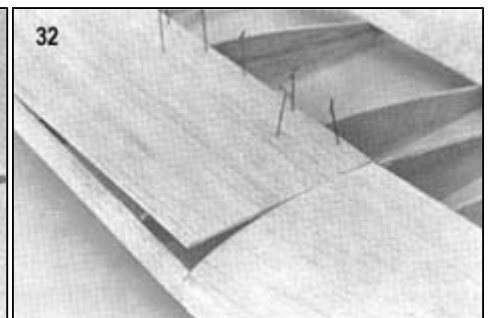
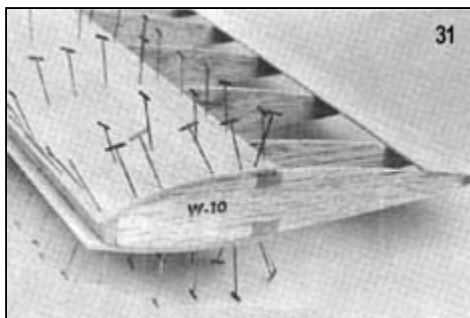

32. Repeat step 30 on the other wing half. Have a good fit and use plenty of glue in the center seam. This is a main factor in wing strength.

33. Add the bottom trailing edge planking. We recommend that this be glued on with epoxy as was the top piece of trailing edge planking. This locks the wash-out twist into the T. E. with the extra strength of the epoxy and will make it immune to being disturbed by covering shrinkage.

34. Using the waste ends of the planking sheets, cover the top of the wing center section. Be sure and use plenty of glue in the center seam. Split the waste piece from each main 36" long planking sheet between the center section and the tip planking of each wing panel. There is enough wood in the waste ends that a little extra can be left to make a neater, rounded corner when trimming.

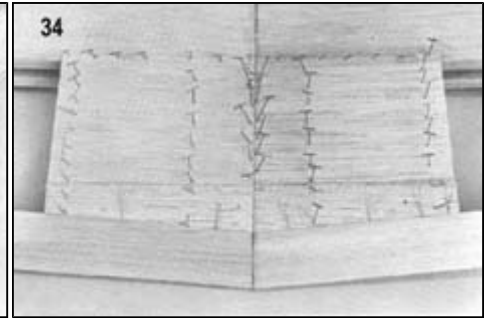
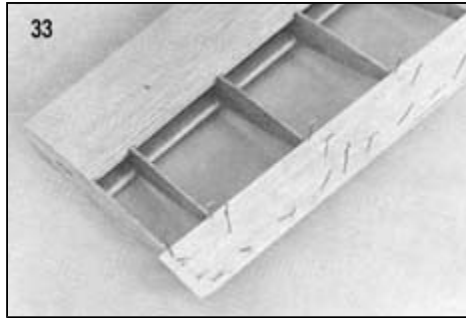

This is not shown on the plans but if you will look at the pictures farther along you will see the kind of rounding referred to.

35. Plank the top and bottom of the tip sections.

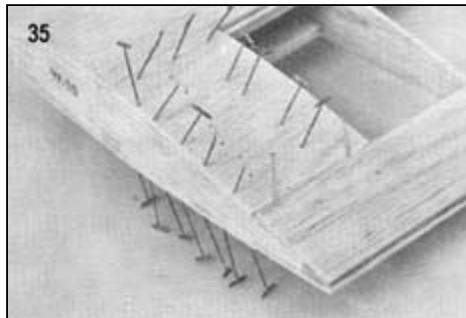

36. Add the 3/32"x3/16" cap strips.

37. Glue on the 3/16" x 3/4" leading edge caps.

38. Trim and sand the leading edge to contour.

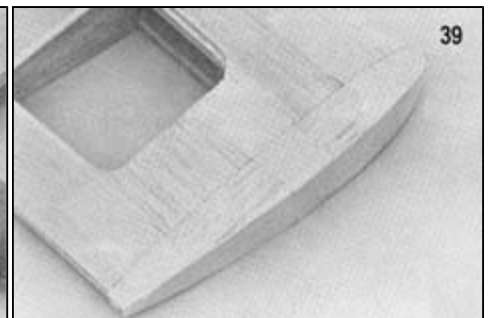

39. Partially shape the wing tip blocks (using the outline on the plan as the top view pattern) and glue and tape them in place. Carve and sand them to the shape indicated in the accompanying cross section drawing. If you wish to hollow them for lightness, only tack glue them on and after shaping, remove the tips and gouge out the interior before regluing on permanently.

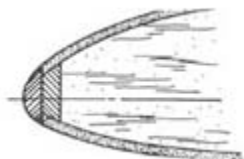

Typical Leading Edge Contour

40. Check the servo and/or servo mount you intend to use in the wing for aileron control and saw out an opening in the bottom of ribs W-1 to accommodate it. The opening being sawed in the photo is 2-5/8" from the back of the spars, so as to leave 2-3/8" between the faces of PW and PS, the amount of room required for an AM-4 vertical plastic servo mount for a Logictrol SM type servo. Remove the sawn out section of Ribs W-1.

41. Epoxy glue the plywood dihedral brace PW in place on the backs of the spars.

42. Add the rear piece PS to form the back of the servo compartment. If your servo requires a wider hole, PS may have to be cut down slightly in height.

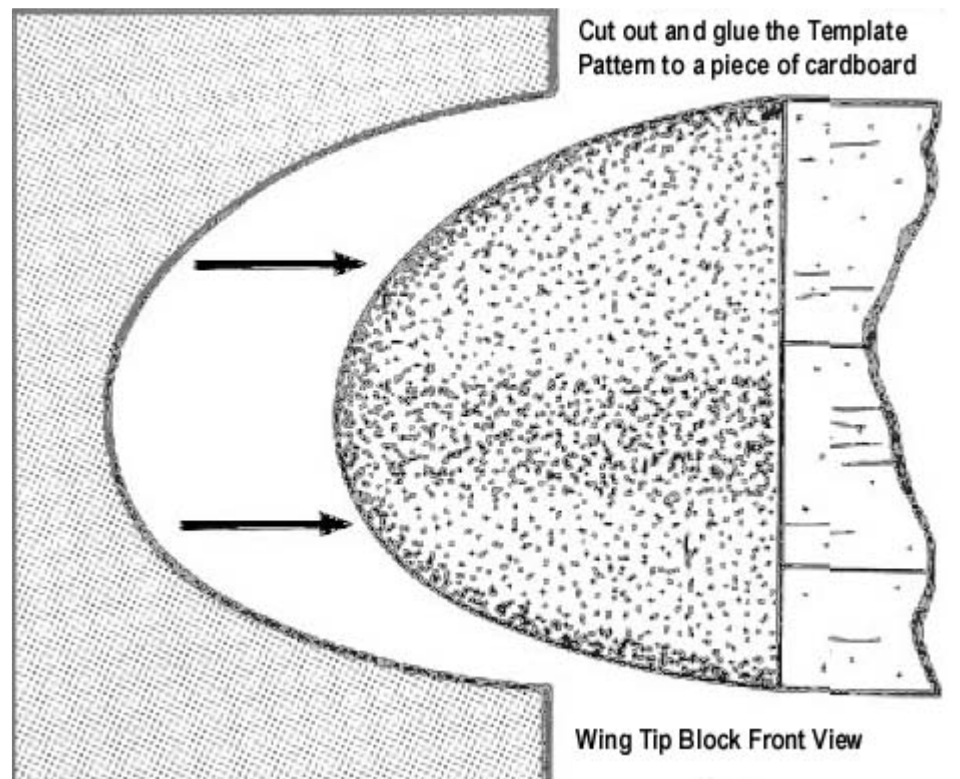

Wing Tip Block Front View

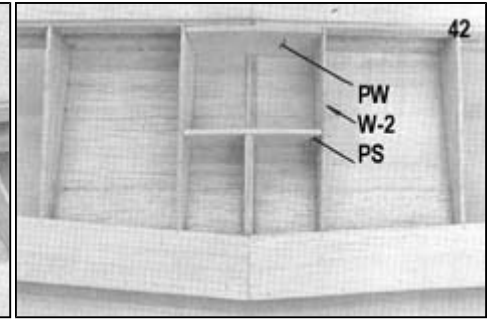
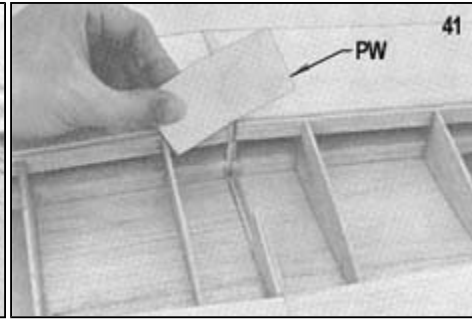
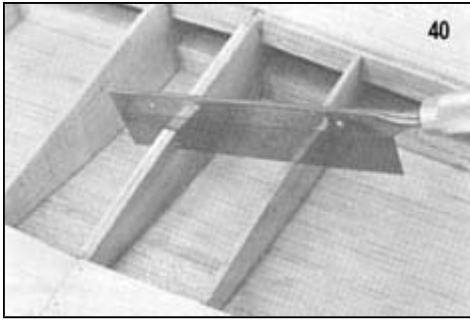

43. Glue scrap pieces of 3/16"x3/4" wood on each side of the opening against Ribs W-2.

44. Plank the bottom of the center section, except for the servo compartment opening, with 3/32" sheet wood waste from the main planking sheets. Use plenty of glue in the center seam.

45. Glue hardwood pieces to PW and PS to serve as rails to hold your aileron servo mount or servo.

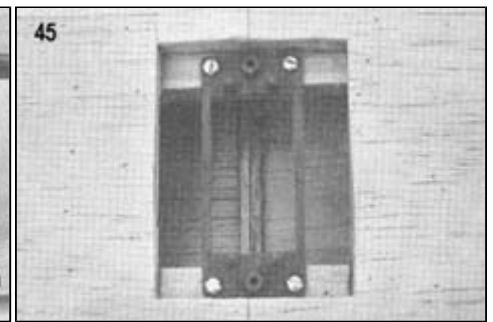
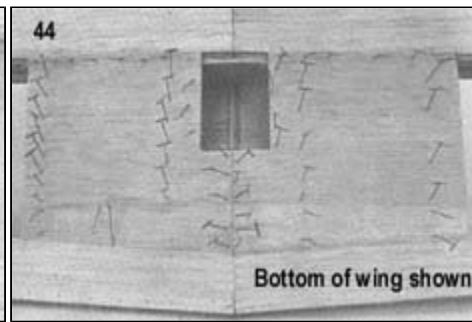
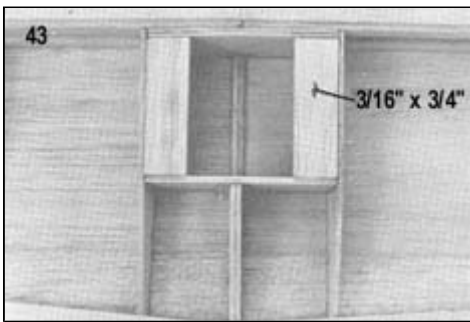

46. Mark the outlines of the areas in which the 1/16" plywood center section pieces WT will be inset and cut out a 1/16" deep cavity.

47. Smooth the cavity with a small sanding block.

48. Epoxy glue the 1/16" plywood WT pieces into the cavity. Line them up straight with the angle of the center section just ahead of them by laying a ruler along it as shown. Leave the rear edge uncut until the aileron is installed and the wing is being fitted to the fuselage so it can be trimmed to the exact dimensions required.

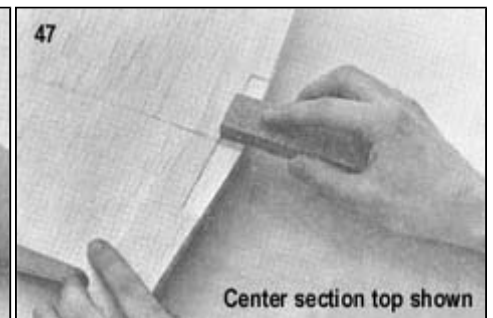
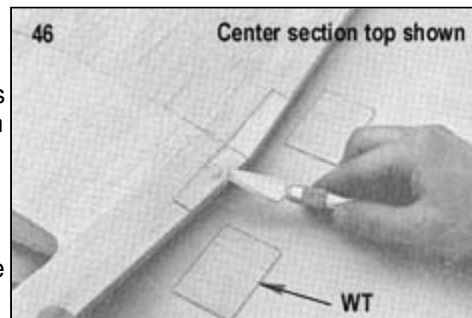

49. The aileron horns are bent in a steel jig by hydraulic power. However, due to variations in spring tension in the wire, there may be slight variations in the horn angle. Set the pair of horns side by side, as shown in the photo. If one is bent farther than the other, give it a twist back, using two pair of pliers. Careful! It is easy to overbend.

50. Notch the formed aileron stock to receive the aileron horns and drill a hole for the end. Epoxy the horns in.

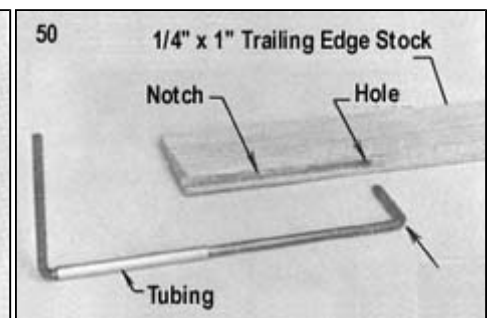
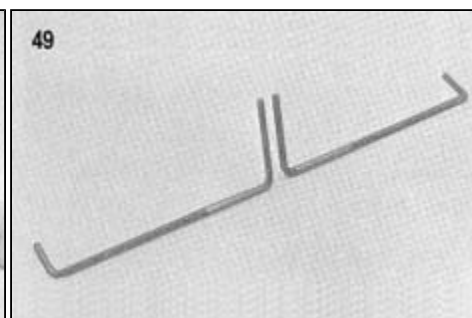
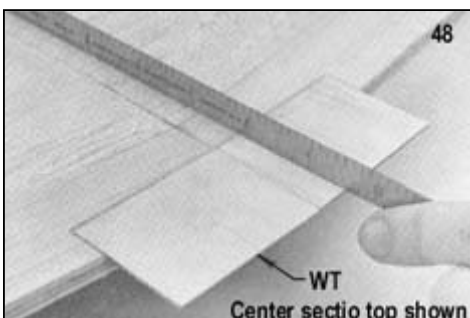

51. Glue the hinges into the ailerons first. Fit the ailerons to the wing and cut slots for the hinges into the wing. Finally, glue the aileron into the wing hinge slots.
IMPORTANT: It is best to cover the wing and ailerons separately before joining them together, particularly when plastic film covering is used. This will leave steps 51, 52, 53 and a small area of covering to be done after the main covering job, but it is the easiest in the long run. The prototype model in the pictures was done by covering the ailerons with silk before fastening them to the uncovered wing. The wing was covered after completing and mounting. Unlike plastic covering, which requires access to the wing edge with an iron, the silk can be lapped down in the gap between the aileron and wing, and glued on with dope.

52. Glue the aileron hinges into the wing first and allow to set up. Epoxy the tubing on the aileron horns onto the trailing edge of the wing and the bottom of WT. The tubing may not actually touch the back of the wing and/or WT, but do not force it into place. Let the tubing adopt whatever position it takes from the lineup of the ailerons and surround it with epoxy glue, allowing the glue to fill any gaps.

53. Fill-in the section around the tubing and WT with pieces of 1/4" x 1" trailing edge stock. Notch out to fit over the tubing and clear the horns. Use epoxy and be careful not to use too much or it may squeeze into the tubing. Sand down the T.E. stock as required, to fit on the fuselage.

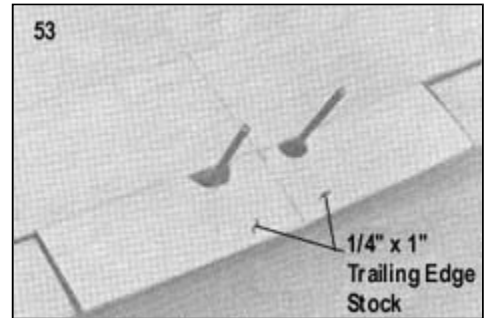
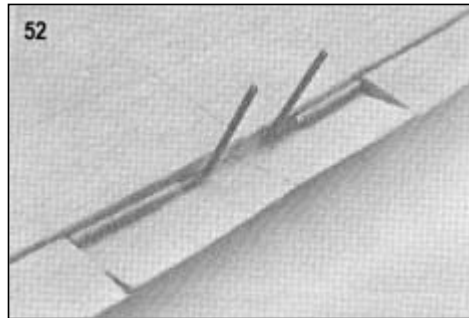

About The Wing Fastening Options

The kit builder has his choice of two ways of mounting the wing on the fuselage.

- **Method One**, using nylon wing bolts, is probably the most popular, but also requires more work and tools. Because of the more complex construction, Method One is fully illustrated in the photo building sequence.
- **Method Two**, using rubber band fastening, was used on the prototype Kavalier. It is considered "old-fashioned" by some, but it has advantages of value to many builders. If you are a novice flyer, not able to make smooth landings every time, or if you fly from a rough field, where "cart-wheel" landings can happen, Method Two will help prevent damage to the model. With the rubber band, the wing can shift, yield or come off entirely when subjected to an overload. During construction, Method Two is simpler for beginning builders to accomplish.

All information necessary for installation of Method Two is shown on the full size plan. About the only departure from the picture sequence, other than leaving off several parts, is to cut out the dowel holes in the printed fuselage sides before covering them up with the plywood doublers. Later on, after the fuselage is assembled, all that need be done is to drill the holes on through the plywood doublers, slide in the dowels across the fuselage and glue scrap wood above them to brace them to the top of the fuselage. Use No. 64 rubber bands to strap the wing in place. Use 10 or 12 bands, 5 or 6 on each side when doing aerobatics. You may use eight for test flights, if the last two are crossed from left to right side and right to left over the wing to make sure the rest cannot slip off in flight.

Please keep in mind that rubber bands vary in stretchiness and strength. Stretch each one to its limit and inspect for flaws before using. If the wing does not seem to be firmly attached, add more rubber bands. Wash rubber bands between flying sessions to remove oil. Oily bands may slip off the dowels.

IMPORTANT NOTE:

The threaded aileron horns now being furnished are about 1/4" longer between the arms than the horn shown on the plan (unless it has been corrected.) Position the new horns as they will be when installed in the wing and drill the hole in the aileron farther out than shown in the drawing, as required for proper placing.

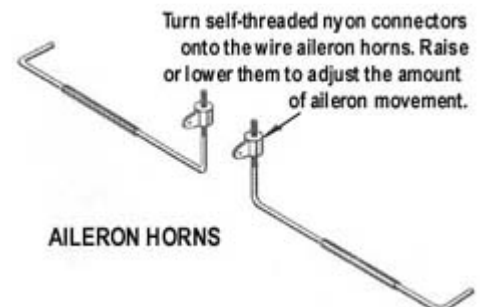

FUSELAGE CONSTRUCTION

54. Smooth and even F-1A and F-1B with the sandpaper block. Glue them together with epoxy glue, as shown in the accompanying drawing.

55. The angled motor mount installation was chosen for the Kavalier to get the fuel tank in the optimum location in the fuselage and at the same time provide for installation of a standard type of muffler at a practical point in relation to the fuselage. Different motors may require different spacing than that shown on the plan.

- Layout the center lines and motor mount positions on the front of the F-1 firewall assembly, using the F-1 drawing on the plan as a guide.
- Position the nose gear bearing and drill holes for the 4-40 bolts.

56. a. Tack glue the motor mounts to the firewall. Bring the glue up over the mount ends to help hold it. (Double coated masking tape can be used for this purpose.)
b. Drill through the mounting holes with a long drill bit. (If you do not have a long drill bit, a length of music wire with a notch filed in the end will do the same thing.)

57. a. Enlarge the holes just drilled in the back side to take the shank of the 6-32 blind nuts on the mounts and the 4-40 blind nuts for the nose gear bearing.
b. Tighten the mounting bolts to pull the blind nuts into the wood. Coat them with epoxy glue to hold in place.
c. Drill a 7/8" hole through the firewall for the tank.

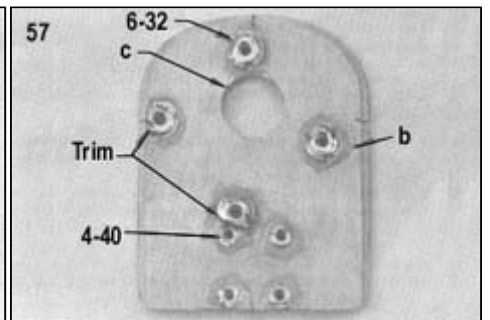
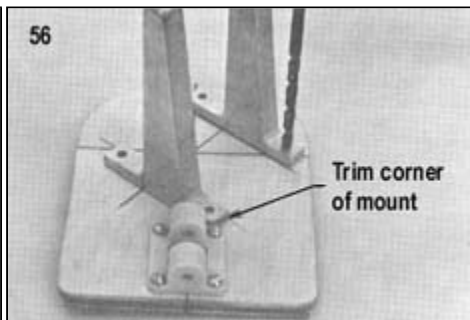
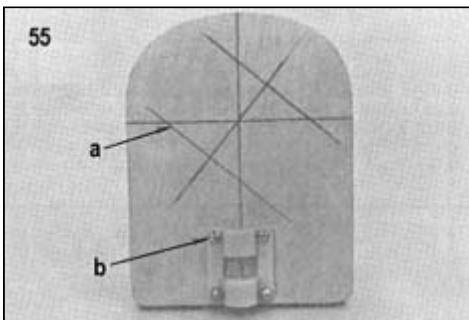
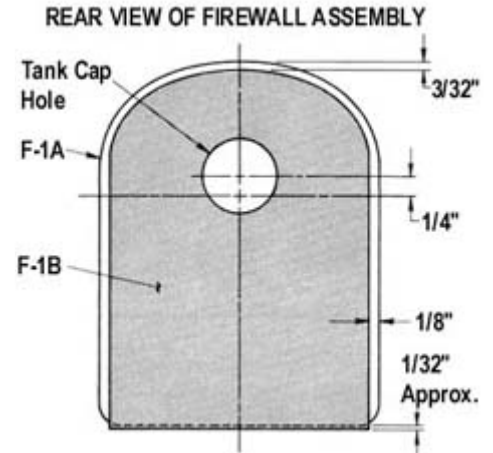

58. a. Bolt the spinner backplate to the motor. (This must be done to allow for differences in spinners. For example, the Goldberg spinner used on the prototype Kavalier has a recessed backplate which requires the motor to be farther forward than a spinner without a recess. This is a good thing, giving more clearance behind the motor for fuel lines, and is one reason, other than the pleasing shape, that we recommend the Goldberg for the Kavalier.)
b. With 5 minute epoxy, tack glue the engine to the mounts so the back of the spinner is 3-7/8" from the front face of the firewall. (This allows for approximately a 3/32" space between the cowl and spinner.)
c. Make a transfer punch by sharpening the end of a piece of 1/8" music wire.
d. Center punch the mounting holes.

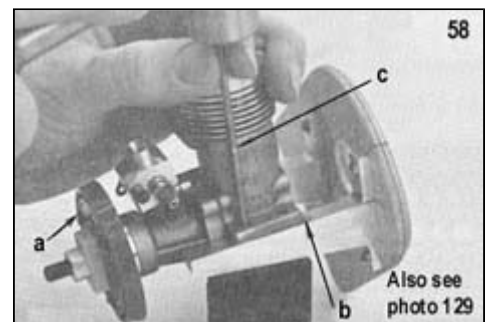

The recommended method of engine mounting is to tap the motor mount holes and use socket head bolts to retain the motor. If you do not have a tap, drill holes through the mounts and use bolts, lock washers and nuts.

STOP!
It is best to fit the cowling to the engine-firewall unit at this time, when they are easier to handle. Refer to the Cowling section further on in the instructions.

59. Sand off the rear ends of the fuselage printed sheets.

60. Glue FT and FB to the ends of the fuselage printed sheets. Use a ruler to line them up exactly with the stabilizer slot.

61. Extend the fuselage datum line of the sides onto the FT pieces and over the end, where it can be located later for lining up decoration stripes or checking the incidence and alignment. (Also, do this at the nose.)

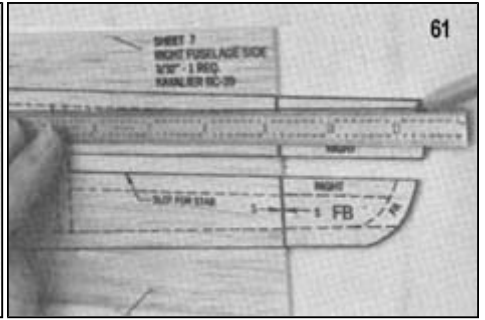
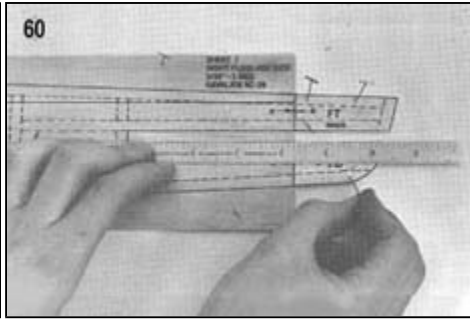
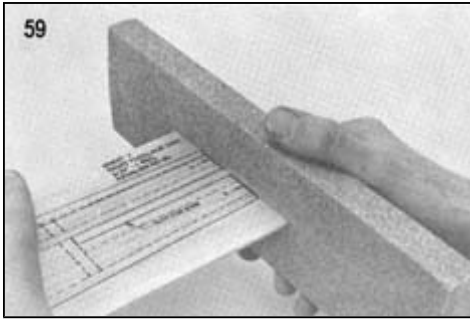

62. Glue the 1/4" sq. bottom stringer in place on the fuselage side sheets. Soak the front section forward of F-2 of the 1/4" square pieces in water until they are pliable and can be curved to follow the bottom outline.

NOTE: If dowels are used, cut out the holes for them in the sides now, before the ply doubler is glued over the hole markings.

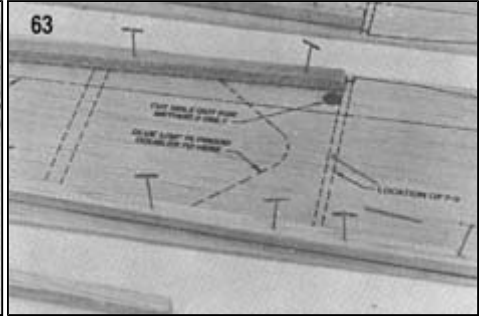
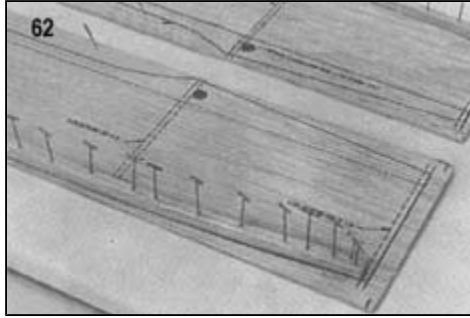

63. Add the top 1/4" sq. stringers. Note that they start just behind the location of F-3.

64. a. 1/4" sq. pieces are also glued above and below the stabilizer slot.
b. The bottom stringer will not quite reach the end, so splice on a short piece of 1/4" sq. to complete it.



65. a. Put in the vertical 1/4" sq. pieces.
b. Glue FA in place.

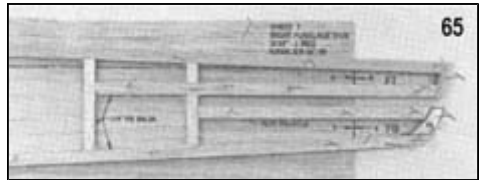

66. Mark the locations of Formers F-2 and F-3 on the 1/4" sq. stringer because the doubler will cover up the location lines.

67. Fit the die-cut plywood doublers FD into place. Sand wherever necessary to make them sit in the proper location. Leave the top black line of the fuselage side visible, don't cover it with the doubler.

CAUTION: Do not glue the plywood doublers on with Sig Bond, Tite Bond, Elmer's, white glue or any other adhesive that has a water base. Water base glue will cause the doublers and sides to curl because of the large area being glued.

68. Because of the built-in right thrust offset to the firewall, the printed right side of the fuselage nose from F-2 forward to the firewall location is slightly shorter than the printed left side. THIS IS INTENTIONAL. However, the ply doubler FD used on the right side must be shortened accordingly to match the printed right side. Lay the doubler in place and draw a trim line on it, using the guide marks that have been printed on the fuselage sheet.

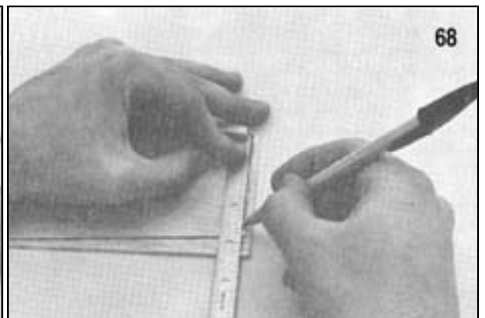
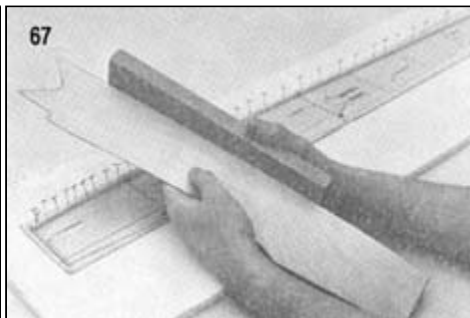
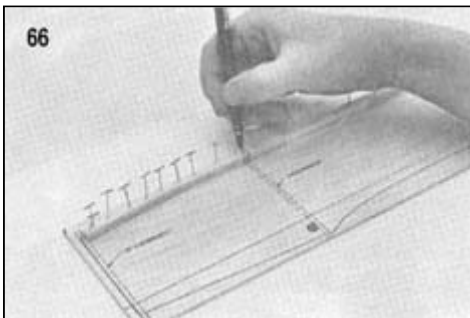

69. Trim off the end of the right side doubler. Spread a thin film of epoxy on the doubler with a paddle. You must work very quickly or the glue will start to set up before you are finished. Don't use a large amount of glue, it will add weight to the model. Rub down the plywood doubler thoroughly with a rag and continue doing it until the glue has completely set up. Full cure of 5 minute glue takes several hours or more so it is advisable to weight the doublers down for awhile for best results without any curling or warping.

Some builders prefer contact cement to install doublers. The main consideration here is to prepare guides beforehand with pins placed so they will steer the doubler onto the exact required spot, for once the glue on each surface makes contact, the doubler cannot be moved. Another aid is to cut a piece of wax paper to cover the glue on the side and slip it out when the doubler is in place.

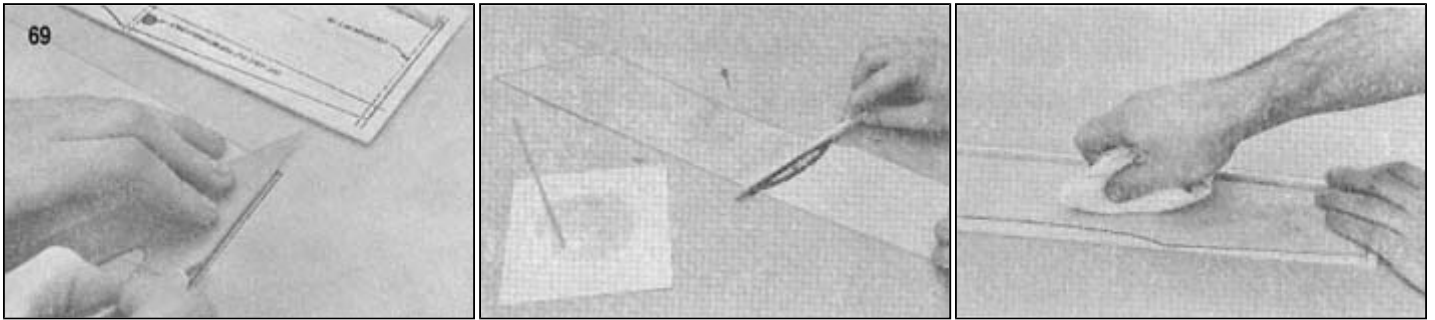

70.
 - a. Use the marks previously transferred to the 1/4" sq. bottom stringer and the other guide marks on the printed sheet to draw guide lines on the doubler to show the positions of F-2 and F-3.
 - b. Also mark the fuselage datum line for any future reference required.
71. Cut the sides out of the sheets and sand the edges smooth. Leave the black line showing completely on the wing saddle and at the front of the fuselage.
72. Cut slots through the 1/4" bottom stringers for F-2 and F-3.
NOTE: If you have selected Wing Mounting Method 2, do not use parts WP and FP and omit steps 73, 74 and 75.
73. Cut WP from the 3/16" plywood piece provided and drill 1/4" holes.

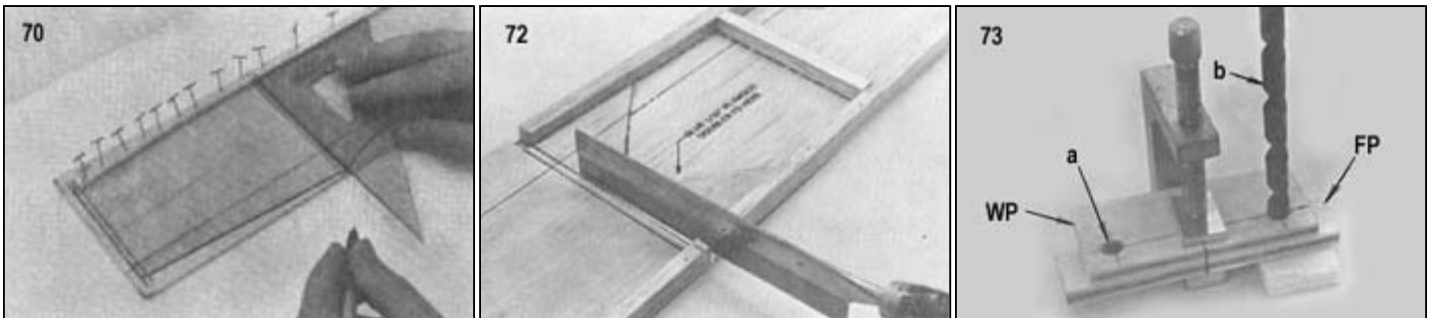

74.
 - a. Glue FP to Former F-2.
 - b. Drill the holes previously put in FP on through Former F-2.
75. Cut short pieces of 1/4" dia. dowel to fit in the holes in F-2 and glue in place.
76. Glue F-2 on one of the fuselage sides, using 5 minute epoxy and holding in place with a triangle for a guide, until the glue has set up.
77. Repeat the process with F-3 on the same fuselage side.
78. Over the top view, join the other fuselage side to F-2 and F-3. Pin and tape the sides in place to hold the parts together until the glue has set.

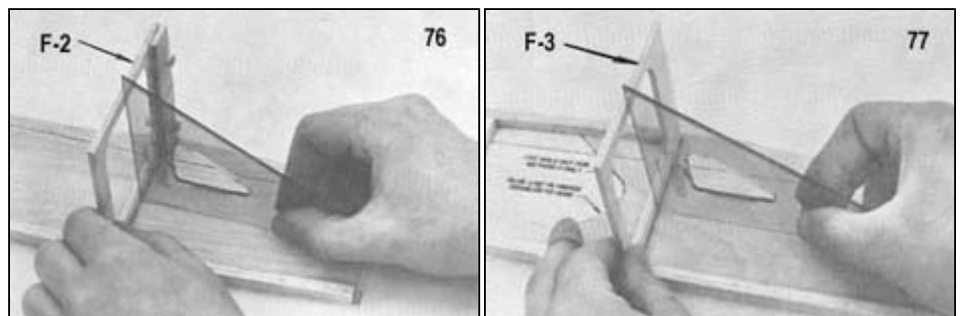
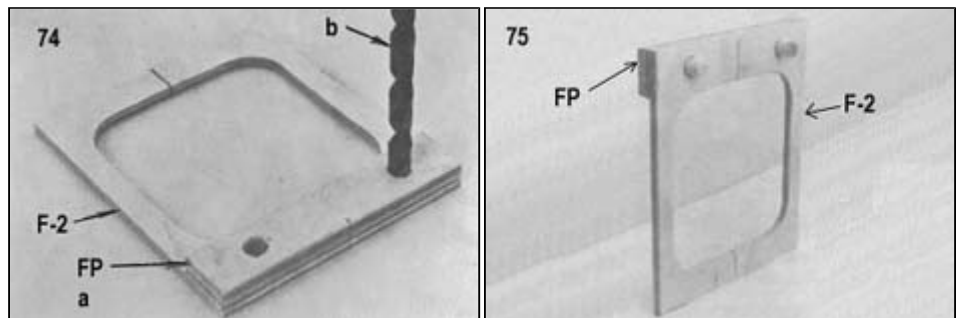

79. Epoxy the previously assembled F-1 unit in place on the front of the sides.

80. a. Turn the fuselage assembly upside down on the top view plan and pin it in place.
 b. Pull the rear of the sides together and join with a vertical piece of 1/4" sq. balsa.

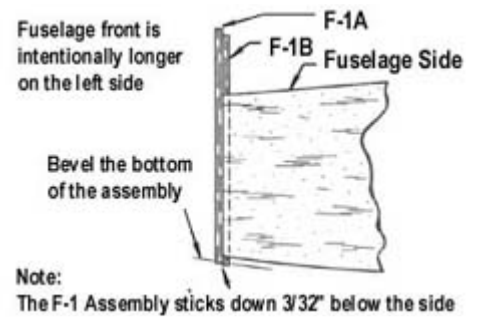
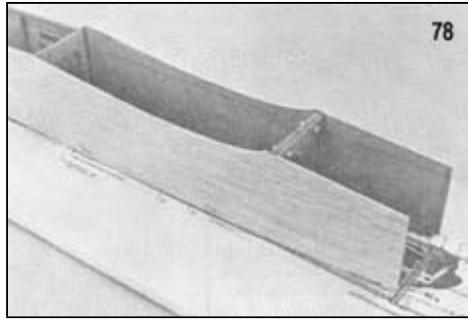

81. a. Add a piece of scrap 3/32" sheet to hold the bottom portion of the sides the same distance apart as the upper portion just joined with the 1/4" sq. vertical piece.
 b. While the sides are pinned down and centered, glue the bottom 1/4" sq. crosspieces between the sides and allow to dry so as to hold the fuselage true when it is unpinned.

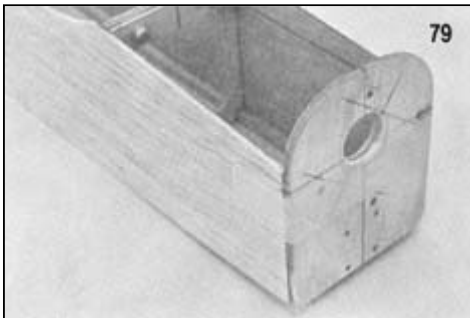

82. Remove the fuselage and install the top cross pieces.

83. Glue pieces of scrap 3/16"x5/8" strip wood on each side of F-3.

84. At the end of the fuselage, fill the top in between the sides with a piece cut from the 3/16"x1-1/2"x9" balsa for fin support.

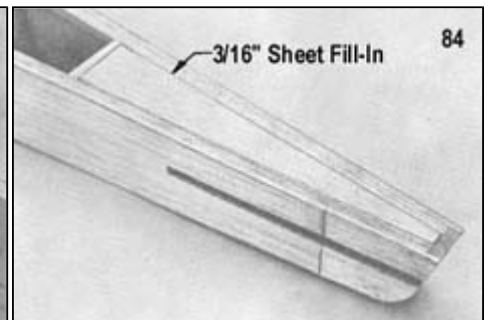
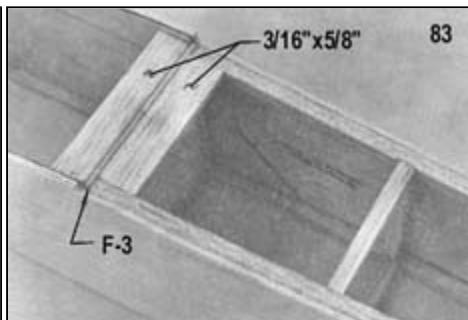
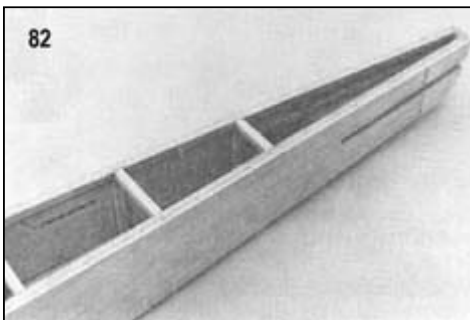

85. Plank the fuselage top behind F-3, with 3/32" sheet balsa. (NOTE: Photo shows grain of the wood crosswise, held to be stronger in the opinion of some builders, but others like to put the planking on with the grain lengthwise for speed of application and easier corner sanding. Either method is approved for the Kavalier.)

86. The picture details the fill-in pieces of wood (not shown on the full size plan to avoid the confusion of too many lines) that are inset between the fuselage sides on the bottom. They form the floor in the radio and fuel tank compartments.

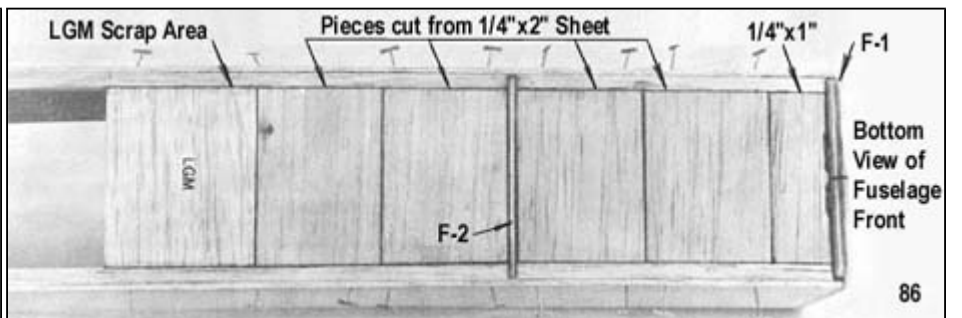
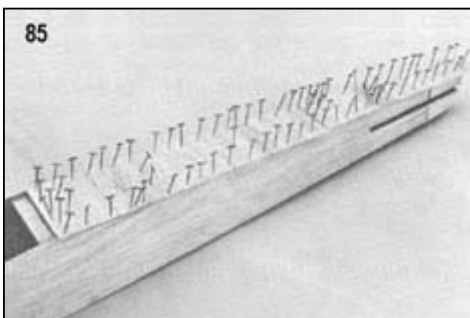

87. The inset pieces in the nose protrude a bit because of the curvature of the bottom. Sand the inset pieces flush with the sides.

88. Glue the 3/32" plywood piece LGB to the fuselage bottom.

89. Plank the fuselage bottom on either side of LGB with 3/32" sheet balsa. (The comment above about grain applies here also.)

- 90.
- Glue LGP plywood to the inside of the fuselage, directly opposite LGB on the bottom.
 - Glue scrap plywood in the corners to brace LGP to the doublers.

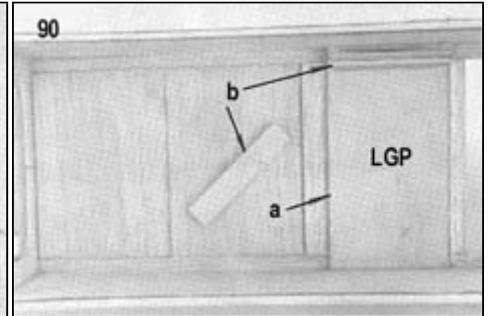
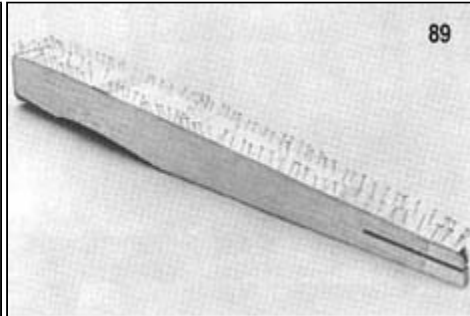
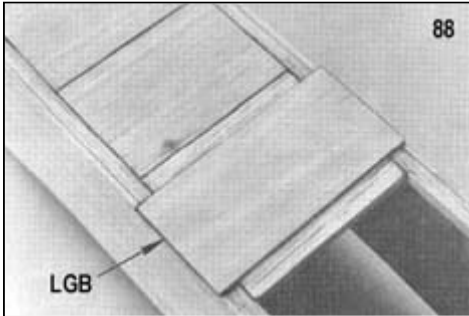
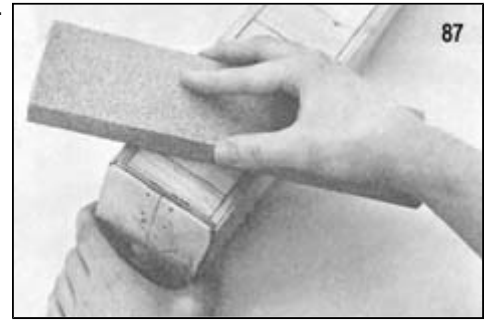

91. Epoxy the wing bolt anchor blocks in place. (If Method 2 wing mounting is chosen, omit the anchor blocks.)

- 92.
- Glue the die cut pieces FW on the interior of the fuselage sides on top of the plywood doubler. Position them slightly below the edge, so that the black line on the fuselage side sheet showing the wing saddle is not covered.
 - Fit and glue pieces of 3/8" triangular stock balsa in the corners of F-2. They will need to be trimmed slightly to clear WP and not obstruct the tank opening in F-2.

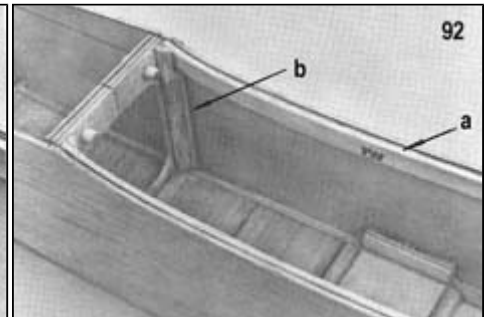
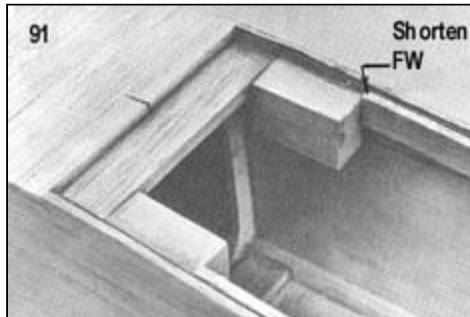

- 93.
- Brace the firewall with pieces of 1/2" triangular stock balsa, epoxied in place. (Seal the holes in covered blind nuts with a piece of tape to keep the glue out.)
 - Fit F-IC into place, cutting away where necessary to clear the blind nuts, the tank hole, etc. The top edge of F-IC should be flush with the top edge of F-IB.

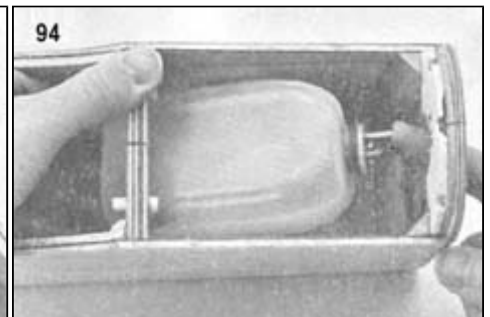
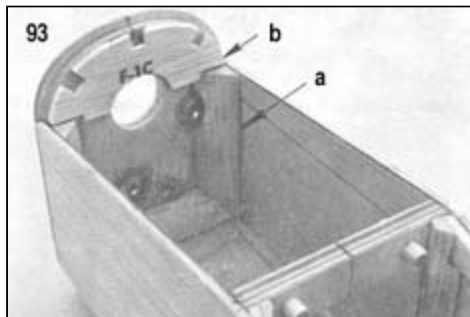

94. Practice installing the tank to make sure that it can easily be passed from the radio compartment on through the tank cap hole in the firewall. Modify anything that interferes with easy placement and removal of the tank.

95. Glue scrap blocks on each side of the tank and at the rear end to hold it in position. Don't get the blocks too tight, just enough to keep the tank from rattling around. The tank will need to be removable after the fuselage top is on by pulling on it from the bottom side. Hold the tank in place with temporary scrap crosspieces across the bottom and the back. They can be broken out when necessary to take out the tank. Or, you can stuff paper or foam rubber and the battery under it for support.

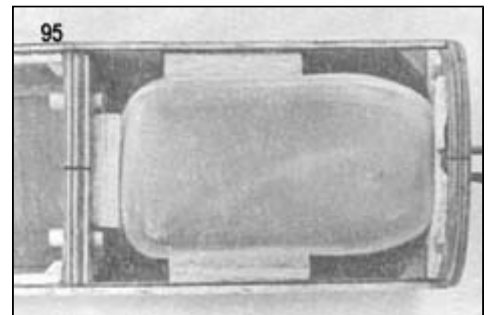

STOP! Don't build any farther until steps 102 through 106 are completed.

96. Install a temporary floor of scrap sheet between the fuselage sides and flush with them, just ahead of F-2 and wide enough to hold gauge G. (Don't glue G to the floor.)
97.
 - a. Put a piece of plastic wrap over the front of the wing and mount it on the fuselage.
 - b. Bevel the bottom of F-2A to sit on top of F-2
 - c. Using the gauge piece G to set the angle, glue F-2A to F-2 with epoxy and allow to set up.
 - d. Remove G and the temporary scrap floor.
98.
 - a. Install 1/4" sq. stringers in the slots in F-1C and F-2A. The slots in F-2A must be beveled to fit the angle of the stringers.
 - b. Bevel the edges of F-2A to conform to the surface angle of the stringers.

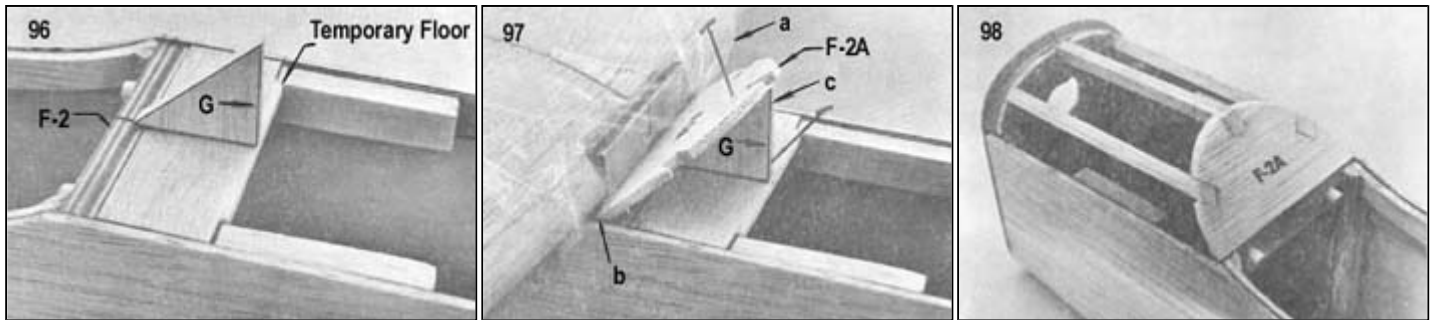

99. Soak a piece of 3/32" x 3" sheet balsa in water until it is pliable. Bend it over the nose section and glue in place with Sig-Bond glue.
100.
 - a. Trim off the balsa, after it has dried enough to stay in place, along the center of 1/4" top stringer.
 - b. Repeat the process on remaining half of the nose.
101. Sand the fuselage corners round with a sanding block.



Mounting The Wing

This requires the wing to be completed through instruction 53 and the fuselage completed through instruction 93.
Skip 102, 103, and 104 if rubber band wing mounting is used.

102. Cut a notch in the leading edge of the wing center to accommodate the plywood piece WP, which had previously been made during fuselage construction.
 NOTE: WP should fit on the F-2 dowel pins snugly but not so tightly as to bind on and be difficult to remove.
103.
 - a. Put a piece of plastic wrap over the dowel pins in F-2. Cut holes in the plastic for the dowels.
 - b. Push WP on over the dowel pins. Put a piece of masking tape over the dowel pins to keep glue from running down over them during the next step.
 - c. Set the wing in place on the fuselage and epoxy it to WP.
104. Remove the wing and brace WP to the bottom of the wing with scrap triangular stock.

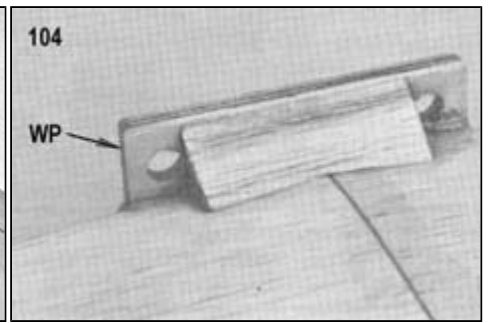
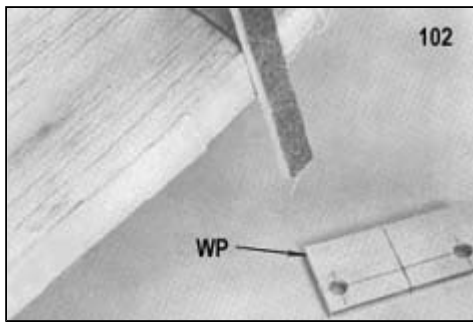

105. Measure carefully the exact spots on the wing to match with the wing bolt anchor blocks in the fuselage. (Remember that the bolts angle forward because of the slope of the top of the wing surface.) Drill through the wing into and through the anchor blocks with a No.7 size drill. Remove the wing and enlarge the holes in the wing only to 1/4" to pass the 1/4-20 nylon wing bolts.

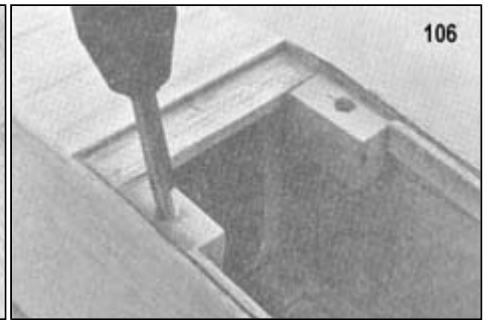
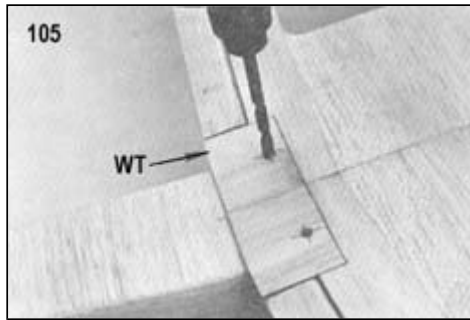

106. Tap the holes in the anchor blocks with a 1/4-20 tap.

107. A good seal around the wing seat is necessary to keep oil and fuel seepage out of the radio compartment. Some fliers use foam tape. Our preference is for a permanent seal, formed from Sig Epoxolite.

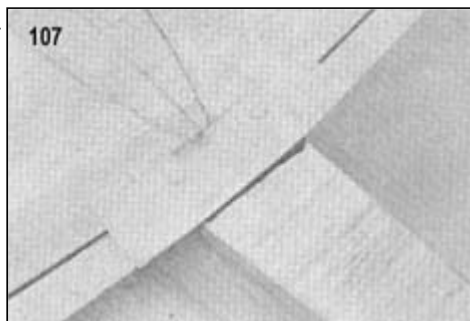

- a. First, cover the bottom of the wing with plastic wrap, stretched smooth, taped in place, with the end brought up over the trailing edge and taped on top of the wing.
- b. Put a bead of Epoxolite around the fuselage edges with enough on the fuselage opening.
- c. Mount the wing, press in place to squeeze out the bead and tighten down the wing screws or put on rubber bands.
- d. Allow the Epoxolite to set up, but not to fully harden. Remove the wing and trim off the excess before it gets too hard.

Fitting The Canopy

This requires the wing and the fuselage completed through Step 100.

108.
 - a. Lay a piece of plastic wrap over the front of the fuselage and mount the wing on top of it.
 - b. Bevel the bottom of F-2B to fit against the wing.
 - c. Put the canopy in place and check the fit to the wing and to F-2B. Through a combination of trimming down the canopy where appropriate and sanding F-2B, work for a good fit of the canopy to the wing contour and over F-2B. Don't trim the canopy around F-2B too closely at this time, leave the final trim for after it is mounted permanently.
 - d. Epoxy F-2B to the front of the wing.
 - e. Sand a piece of 3/8" triangular stock to fit snugly against F-2B. Epoxy it in place to brace F-2B.

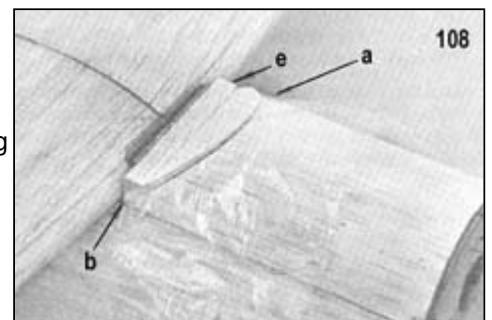

- 109.
- Place the canopy on the wing and draw around it with a pencil.
 - Soak a piece of 1/8" sq. in water until pliable. Glue it in place, slightly inside of the pencil line to allow for the canopy thickness.
 - When dry, the 1/8" sq. balsa must be carved at appropriate angles around the outside so that the canopy curvature will fit over it.
 - Glue the canopy to the 1/8" sq. rails with Sig-Ment, used sparingly. It is recommended that the canopy be left off the model until the very last, after covering and painting the wing.

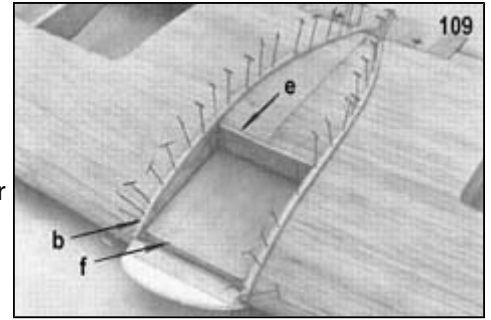

Providing For A Pilot

Materials are not supplied for the optional installation of a pilot figure but picture 109 also shows the modifications to the wing required to have a place to mount him.

The planking should be removed from the center section back to the spar. Leave a little planking on each side near rib W-2 to support the 1/8" sq. canopy rail or put a doubler on the rib. Remove the top part of ribs W-1.

- To replace the loss of strength from making the opening, glue a piece of plywood similar to PW to the front faces of the main spars.
 - Add a floor from balsa or 1/32" plywood.
- 110.
- Make an instrument panel hood from block balsa and epoxy in place over the leading edge. This also adds strength to the opening.
 - A Williams Bros. 2" scale pilot figure was used in the prototype Kavalier. A block of balsa can be glued to the pilot bottom if he is not sitting high enough.

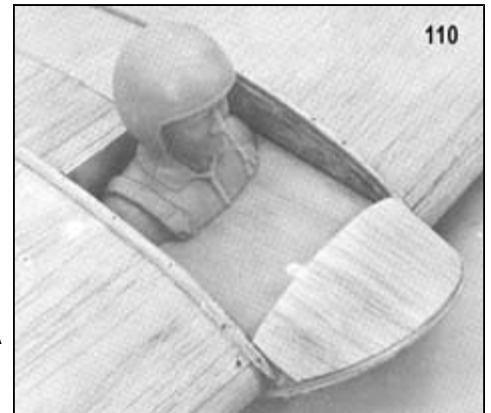

Fin Assembly

111. Sand the parts of the fin with a sanding block so that the seams fit together properly.

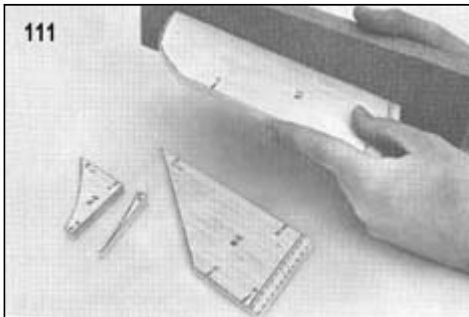

112. Glue the parts together on a sheet of wax paper.

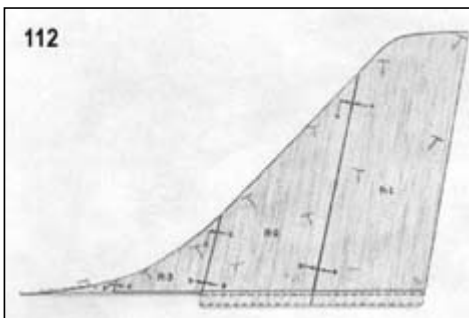

Three Ways To Glue On A Fin!

Since the invention of epoxy, we've always glued the fin directly to the top of the model without inseting it into a slot or bracing it with triangular fillets. Done properly, this method holds well enough in flight yet will knock off cleanly in a flip during a bad landing (and thus can be easily replaced.) But the joint must have wood-to-wood contact, with holes punched into each surface and using plenty of glue, filling the holes and the joint. We've never had a fin become detached or loose in flight.

However, some modelers don't feel secure with surface gluing, so provision is made on the Kavalier fin printed parts for a large tab that can be left on and inserted into a full depth slot cut into the planking and the fill in wood beneath it for a very solid attachment. This method is shown in the following photos.

Or, for a third alternative, you can cut the tab shorter on the dotted line and only have a slot cut into the planking, with the fill-in wood beneath left solid. This is a compromise between the first two choices. It has more gluing contact than surface mounting yet can still break off cleaner than full depth mounting.

If you are in any doubt about what your choice should be, then we recommend you follow the photo sequence.

113. Smooth and level both sides of the fin. In the process, the ink lines will be removed.

114. a. Mark a center line on the fin as a guide.
b. Round the leading edge of the fin.

NOTE: To do the next steps, the fuselage must be completed through at least step 85.

115. a. Using the center line mark at F-2 and the center mark on the back of the fuselage, draw a center line for the fin on the fuselage top.
b. Draw side lines on either side of the center line to mark the fin position.
c. Cut a slot to accommodate the tab on the bottom of the fin (if you are using the tab.)

NOTE: You may want to cover the fuselage, the fin or both before epoxying the fin on permanently.

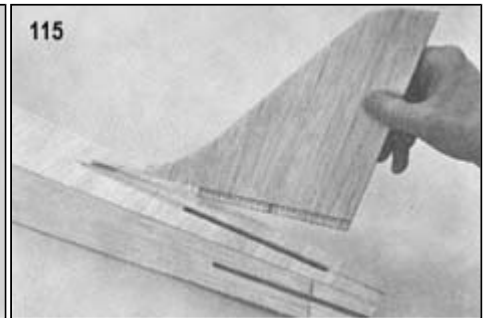
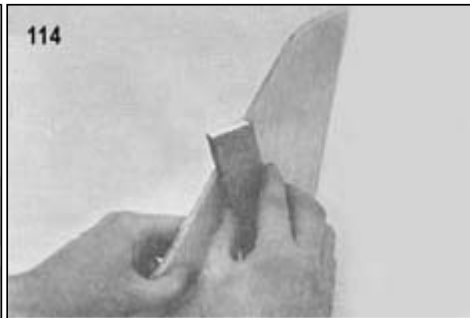
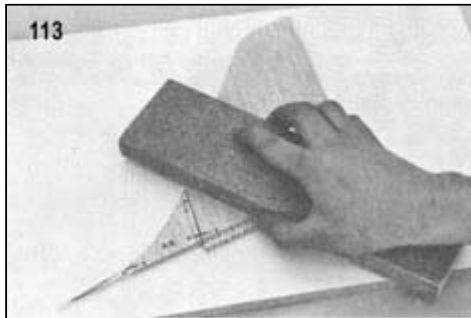

Stabilizer

116. Cut pieces of 1/8"x3/8" strip to size. Pin and glue in place on the stabilizer plan.

117. Continue by cutting the inner cross-pieces to approximate length.

118. Finish the pieces to exact fit with the sanding block.

NOTE: The procedure described in the following steps in which both sides of the stabilizer are planked nearly simultaneously, before the glue has dried on the first side, was found to produce a truer and flatter stabilizer.

119. Pin a strip of 1/16"x3" balsa planking to the stabilizer. Do not wait for it to dry, proceed to the next step.

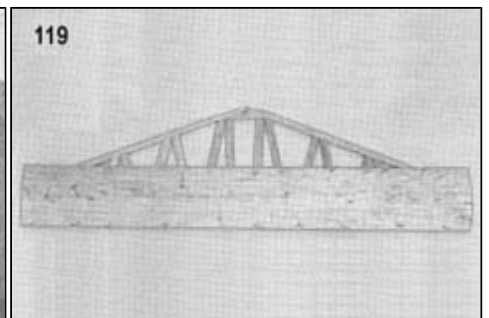
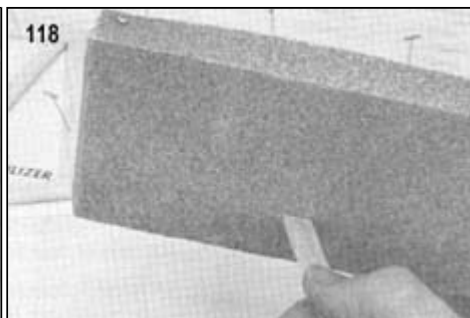
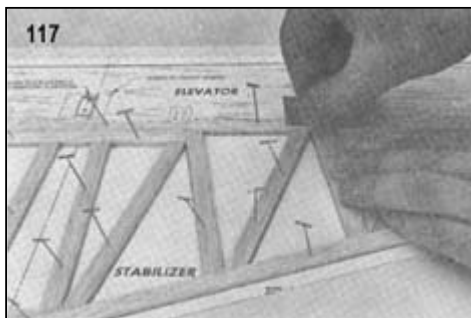

120. Cut a piece of planking to fit the remaining area and glue it in place. Do not wait for the glue to dry completely. Let it dry a few minutes to get a grip on the parts, remove the pins and turn it over on the building board.

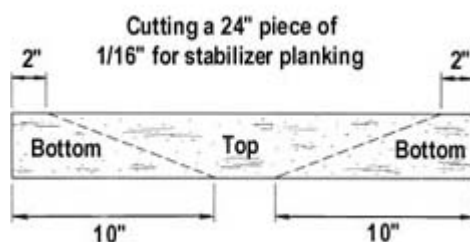

121. Repeat on the other side with another strip of 1/16" x 3" wood.

122. Use a waste piece left over from the top to complete the planking.

123. After the second waste piece is added, leave the stab pinned down until it is completely dry.

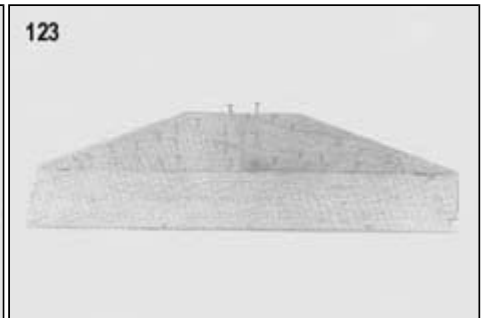
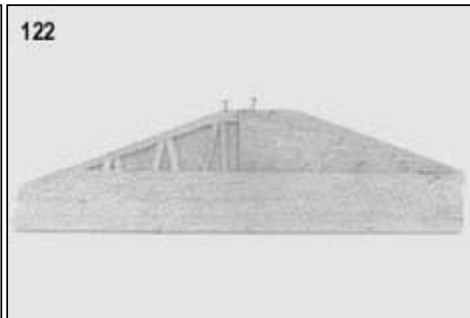
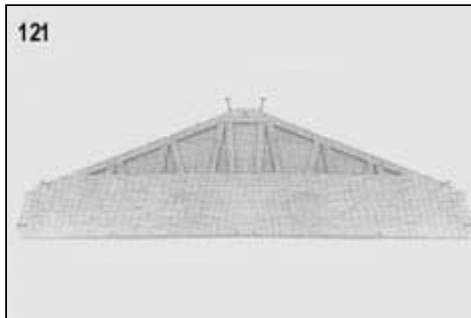

124. Sand the stabilizer smooth with a sanding block. Round the leading edge in the same manner as the fin was shaped previously. The elevator is hinged to the stabilizer in the same manner as the ailerons.

NOTE: You may want to cover the stabilizer, the fuselage or both before gluing the stab permanently on the fuselage

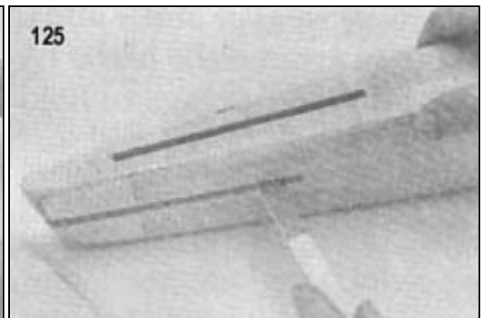
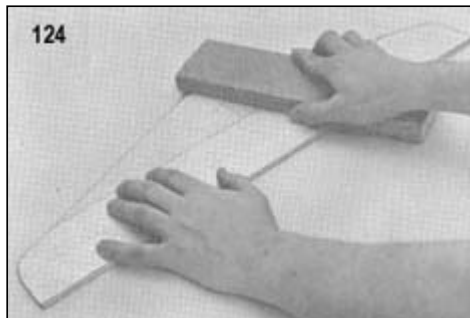

125. Fit the stab into the mounting slot in the fuselage. If the slot is too tight, open it up a bit as required, with the sandpaper file. Be sure that the stabilizer is lined up square with the fuselage. Coordinate the fitting of the stab with the fitting of the wing. Remove any stabilizer covering that touches the fuselage in the glue joint so there will be wood-to-wood contact.

Cowling Installation

CAUTION: Don't try to cover the cowl with plastic film. The iron heat will damage the cowl.

126. To make openings in the cowl for the engine, first drill a series of holes about 1/8" in diameter around the area to be removed. Cut through the bits of plastic between.

- 127.
- Remove the carburetor from the engine during the initial stages and work with the cylinder head hole.
 - Cut a slit out the back of the cowl from the cylinder head hole to assist removal.
 - Start the hole undersize and open it up slowly, fitting as you go so it doesn't end up larger than necessary.

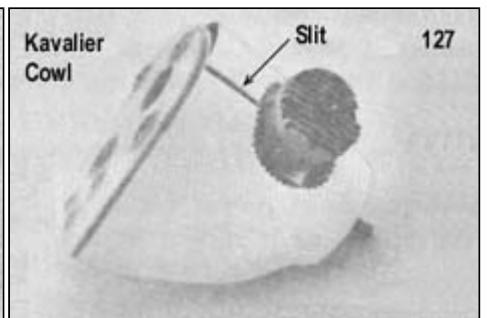
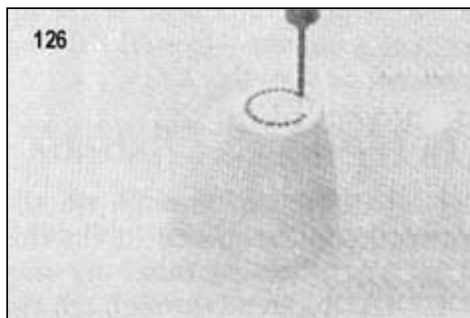

128. The best way to open up the hole is to go around the edges with an "apple-peeling" motion, paring off a small amount of plastic with each stroke.

- 129.
- Cut the hole for the carburetor last.
 - Round all of the corners.
 - Put the spinner backplate on during final cutting to check exact cowl position.

130. After the fuselage construction is completed, the cowl may be mounted.

- a. Epoxy the hardwood cowl blocks to the firewall.
- b. Place the cowling in position and put on the spinner backplate.
- c. Tape the cowl in place and drill small pilot holes into the blocks for the screw locations.
- d. Enlarge the holes in the cowling only to pass the No.2 screws.

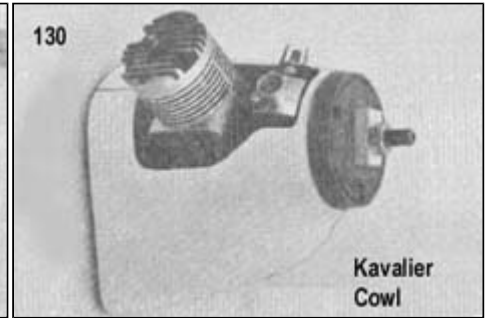
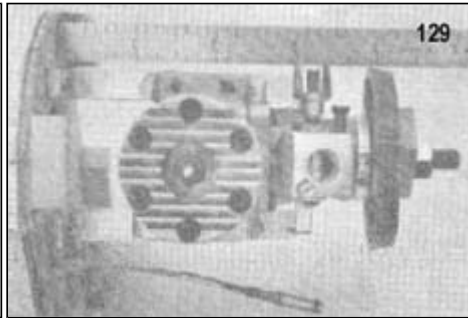

Main Landing Gear

A heavy duty 8-32 x 1-1/2" axle bolt is included in the Kavalier, so the axle hole in the aluminum gear must be drilled out. Use a No. 18 or a 11/64" drill.

131. Hold the aluminum gear in position on the bottom of the fuselage and drill through the plywood landing gear parts LCB and LCP.

- 132.
- a. Drill out the holes on the inside of the fuselage to accept the shanks of 4-40 blind nuts. This will require a 9/64" drill.
 - b. Replace the gear and install the 4-40 x 3/4" bolts and 4-40 blind nuts. Tighten the bolts to pull the points of blind nuts into the wood. Coat the edges of the blind nuts with epoxy glue to hold them securely in place.

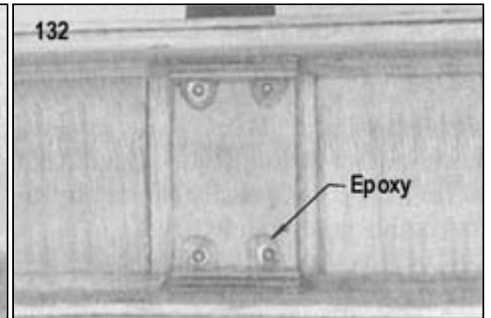
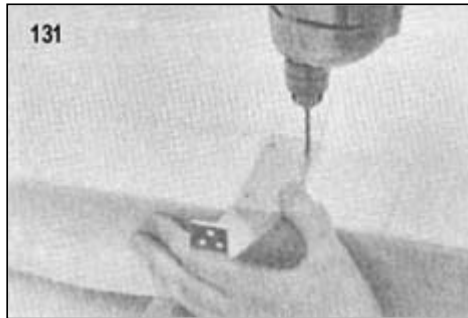

Nose Gear

- 133.
- a. The nose gear is held in the nylon bearing by the steering arm. Angle the arm forward so that when the servo pulls it back for a left turn, the arm will clear the face of the firewall. NOTE: Use the middle hole in the steering arm.
 - b. A flexible steel cable pushrod with nylon outer tubing (not furnished) is recommended for the hookup of the nose gear, such as the SIC SH-559 Flexible Cable Pushrod. Run the nylon outer tubing through the firewall at the right spot to connect the inner cable to the nylon steering arm. Epoxy around the tubing at the firewall so that no oil will leak back into the fuselage.
 - c. Sweat solder the last 1/2" of cable and file the end to a point so it can easily be inserted in the adapter fitting on the steering arm.
 - d. Hold the wheels on the axle with a 5/32" diameter wheel collar (not furnished.) Or you can solder a washer on the end of the axle. Protect the wheel with a shim of light cardboard that can be torn and removed after the soldering operation. "Low Bounce" type wheels are recommended.

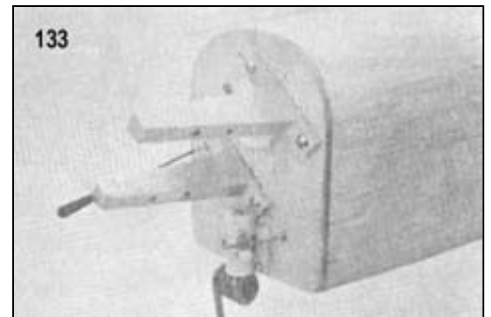

FINISHING

The Sig Pushrod Connector included in this kit can be used for attaching the nosewheel pushrod cable to the steering arm as shown here.

Additional pushrod connectors can be purchased (SIGSH736) for use on the throttle and nosewheel servo arms. Adjust by loosening the set screw and sliding the cable.

Tips On Tanks

134. Assemble the tank hardware as shown in the photo.

We occasionally receive suggestions from builders that a removable hatch be designed into a model for access to the gas tank. Our opinion is this is not the best method in most cases. The hatch opening makes the nose weaker and there is no good way to keep oil from leaking in around the hatch. A method of fastening has to be built into the fuselage to hold a hatch in place.

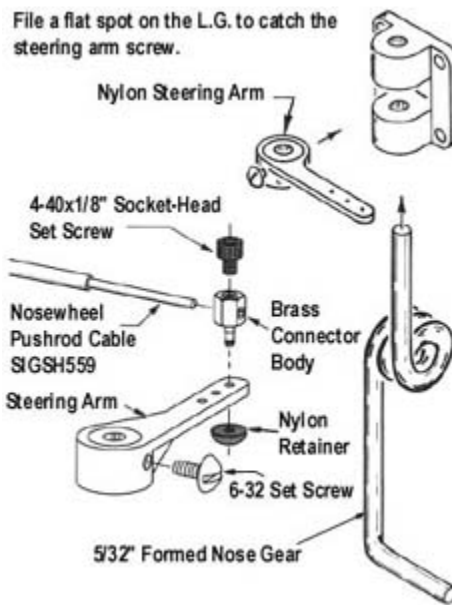

PREPARING CABLE PUSHRODS

To keep ends of cable from unraveling during handling, tin the end with solder. Use a non-corrosive paste flux (shown here is Kester, available at hardware stores) and rosin core solder. Have a hot iron and flow the solder completely through the cable.

Grind or file the end smooth. Bring it to a point so that it will easily insert into the pushrod fittings.

After the proper length is arrived at, sweat solder the area to be cut so that it will not fray and unravel while being cut. It can be cut with a good pair of side-cutting pliers, filed in two, ground through on the edge of a grinding tool, or cut with a silicon cutting wheel on a motor tool.

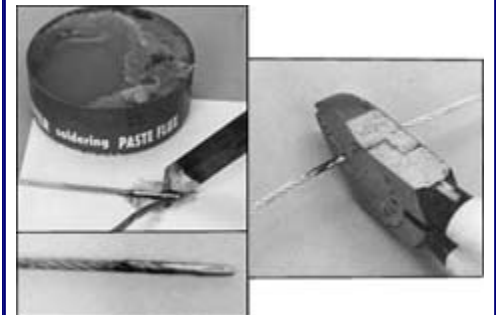

Modern plastic tanks are virtually indestructible under normal use and bursting or cracking is almost unknown. If you use Sig Heat Proof Silicone tubing (which will not harden or deteriorate in fuel) in the plastic tank, the tank will seldom have to be removed. We have models in which the tank has been installed for three or four years without ever needing removal. So it is quite practical to put the tank in semi-permanently. Check the models at a contest, you'll find that the majority have sealed noses, as does this kit.

Read this before you drill the 7/8" firewall hole.

Some fliers prefer not to bring the tank cap through the firewall as is shown in the construction sequence in these instructions. Instead they drill two holes for the vent tubes only and make the vent tubes long enough to extend through the firewall. This method requires little sealing but it is more difficult to install and remove the tank. The best way to manage this is to feed long pieces of fuel line through the holes and attach them to the tank in the cabin area. Steer the tank into the nose as the tubes are pulled back through the holes. If you are undecided as to which method you should use, my advice is that the large hole installation shown in the construction pictures is the best for beginners.

Put scrap wood supports under and at the back of the tank. The front is supported by the 7/8" hole in the firewall. Seal the tank cap in the hole with G.E. Silicone Bathtub Seal or Devcon Seal-It. Put an oil-proof finish on the firewall and in hole before sealing the tank cap. Get some of the sealer on the sides of the hole and also put a bead over the edge of the cap on the front. Should you need to remove the tank, break out the scrap wood supports in the rear and push out the silicone rubber seal around the front cap. Reach into the fuselage and guide the tank outside.

Some builders, after putting their receiver battery in a plastic sack, taping it shut, wrapping it in a foam rubber package and stuffing it into the nose under the tank, then stuff paper toweling or foam rubber in to fill the nose compartment and keep everything firmly in place.

After installation, put fuel tubing on the vent tube and run it to the outside of the cowling on the bottom, so that fuel overflow is not blown over the wing-fuselage joint, where it may leak into the fuselage. The best way to fill the tank is to take off the fuel line to the needle valve and pump the fuel in there until it runs out the vent. Be sure and use a filter on your fuel supply can, and it is a good idea to have a filter between the tank and needle valve also.

Pressure Feed

If the engine you are using is equipped with a muffler pressure tap, make use of it for more even fuel feed and reliable operation. The hookup for pressure is shown in the picture. To fill the tank, remove fuel line from the needle valve on the engine and pump the fuel in. When the tank is full, it will overflow through the muffler pressure line. Use transparent or translucent fuel line so you can see the fuel starting to overflow when the tank is full. Should some fuel happen to get in the muffler, drain it out before starting the engine. Do not try to fill the tank in reverse from the pressure line, the tank will not fill properly and fuel may be forced into the engine.



Radio Equipment Installation

The most convenient method of installing servos is on the plastic mounts which most radio equipment makers offer with their outfits or as an accessory. These are screwed to hardwood mounting rails for fuselage servos or to hardwood blocks for mounting in the wings. Instructions for the use of these mounts are included with them.

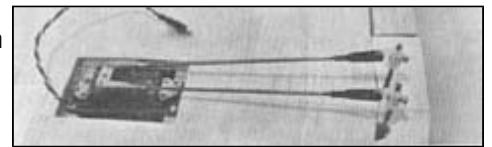

Servos for which plastic mounts are not available can be screwed directly to the two 3/8" square hardwood rails placed across the cabin, three abreast as shown in the accompanying drawing. With rubber grommets installed in the servo mounting holes, mark the spots for drilling the pilot holes for screws. Space the servos at least 1/8" apart and do not have them contacting the hardwood mounting rails except on the grommets. Using a washer on the wood screws, mount the servos to the rails. Do not tighten the screws down against the grommets since this will cause vibration to be transferred to the servos. The washer should rest against the grommet without compressing it.

Cut a slot in the fuselage top planking 1/4"x1-1/2" on the left side of the fin. Bring the rudder push rod through this slot by bending the RC link as required to clear the fuselage. A variety of quickly detachable push rod retainers are available from the Sig Catalog for hooking the push rods to the servos.

The switch may be mounted wherever convenient on the side of the model, preferably the side away from the engine oil.

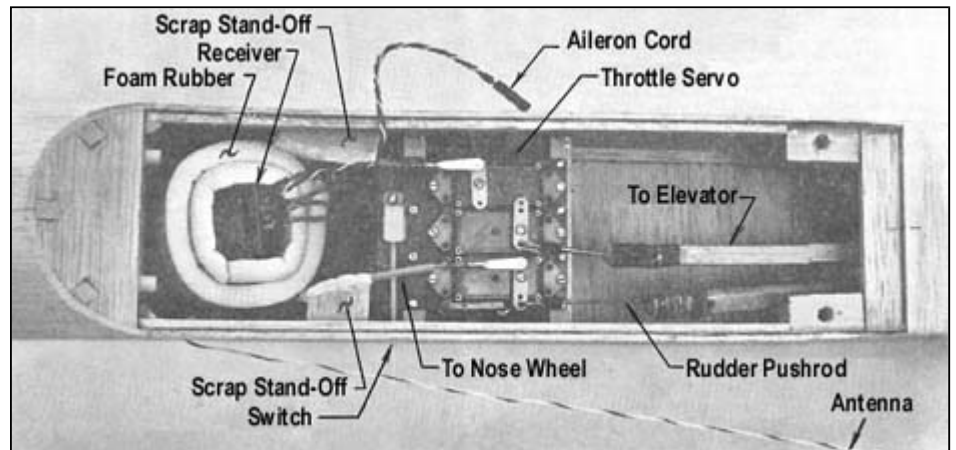

The receiver battery pack should be wrapped in foam rubber sheet, held on with rubber bands. Place it as far forward as possible, under the tank. It is a good idea to put the package in a small plastic bag, taped shut around the battery cable to protect the battery from accidental fuel leakage.

The receiver should be similarly wrapped up in foam rubber to protect it from engine vibration. Cover it with a plastic bag also. Stow this package in front of the servos. Make certain that the receiver will stay in place during aerobatic maneuvers.

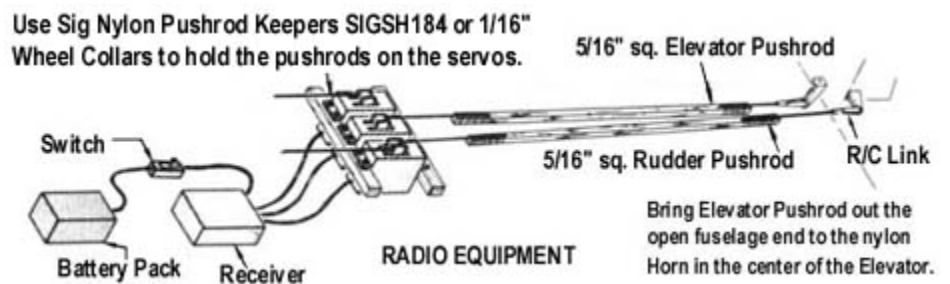

NOTE: Some R/C sets have one reverse direction servo that will require an opposite hookup than that shown in the above for Logictrol radios. Mosr fliers use the reverse servo on the rudder. This puts the nose wheel pushrod against the fuselage side without a cross-over being required.

Cable Pushrod Installations

Here are some typical uses of tubing-cable pushrods. Use scrap block standoffs where required to hold the cable in position. The model shown is not the Kavalier.

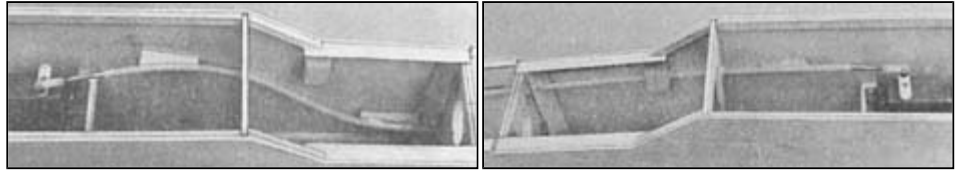

Control Horns

135. The control horns should be installed before covering, then removed until covering is completed. The original Kavalier, had a silk and dope finish. This type of covering makes a fairly hard "shell" on the balsa so plywood reinforcement in the control horn area was not necessary. In fact, we have never reinforced surfaces around horns and they have always stayed intact. If you cover the model with something else, or even if the dope finish is light, it will probably be better to inset a plywood scab into the wood (use epoxy) as shown in the photo. This will keep the horn from pulling out of the wood. Note also, in picture 135, the slot for the rudder pushrod.

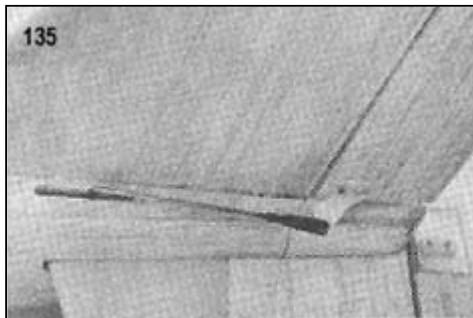

INSTALLING EASY HINGES

Using a No.11 X-Acto blade (or similar) cut a slot approximately 1/2" in depth and slightly wider than the hinge. After all slots have been cut, insert an Easy Hinge halfway into each slot in one of the pieces to be hinged. Then carefully slide the matching model part onto the other half of the hinges. You'll find it easiest to slide the part onto the hinges at an angle, one hinge at a time.

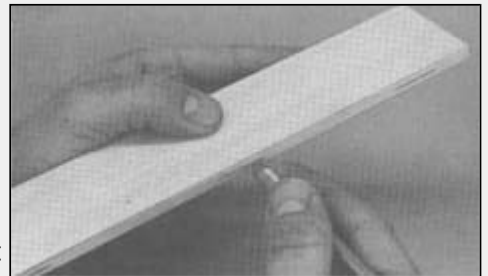

At this point the surface to be hinged is attached but not glued. Align the two surfaces and adjust the gap between them as required. For best control response, the gap should be as small as possible but big enough to allow the control surface to move to the maximum deflection that you will require.

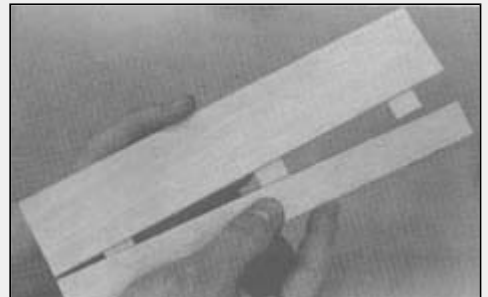

Place three or four drops of any brand of cyanoacrylate adhesive (thinnest variety) directly onto the Easy Hinge in the gap. You will notice that the glue is quickly wicked into the slot as it penetrates both the wood and the hinge. Continue this process, gluing the same side of all of the hinges. Then turn the surfaces over and repeat the gluing process on the other side of each hinge. After the glue has cured, approximately three minutes, the joint can be flexed. You may notice a slight stiffness in the joint. This can be eliminated by flexing the surface to full deflection each direction a couple of dozen times. Don't worry about shortening the life of the hinge as they are almost indestructible.

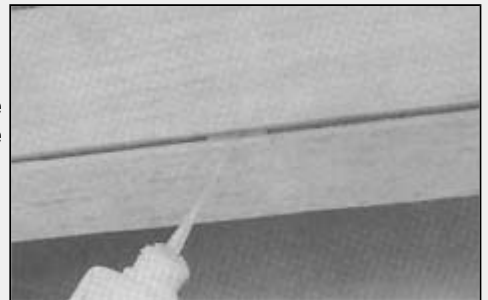

136. The elevator pushrod exits through the opening in the fuselage rear. Open it up as required to pass the pushrod. The pushrod wire may be bent slightly if it tends to rub on the fuselage. Take note that the elevator horn arm is centered on the elevator, not the horn mounting holes, which must be offset to locate the arm in the center of the fuselage opening.
NOTE: If the R/C Link fits too tightly in the nylon horn holes, drill the holes out with a no. 51 size drill.

Servo Hook-Ups

Having the proper connector makes servo installation much easier. We show here a variety of ways to attach push rods to servos.

The Rocket City 07 Pushrod Retainer works okay for hooking the wooden push rods to the servo unless the movement or pushrod angle chosen makes it bump into the center post of the servo at the extreme end of the movement. (This can be fixed by changing the angle of approach to the servo or using a longer arm to bring the retainer out farther away from the center post of the servo.) This retainer is very easy to attach and detach.

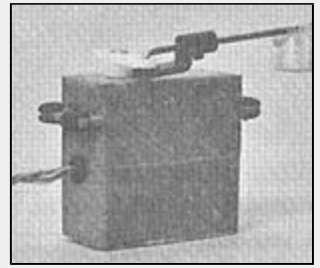

Du Bro Ball Links, which come in several different types, threaded, bolt-on, rivet, etc., gets the push rod action up above the control arm so the pushrod can approach from a variety of angles without any chance of interfering with the servo center post. It is good for cable pushrods. A fine adjustment can be made by screwing the end in or out.

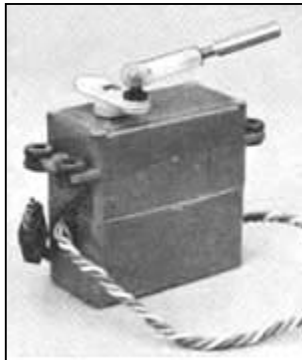

The SIGSH736 pushrod connector is handy for cable end attachment, as on the nosewheel steering arm, but can also be used on servos as shown. They are easily adjustable by loosening the screw and sliding the cable.

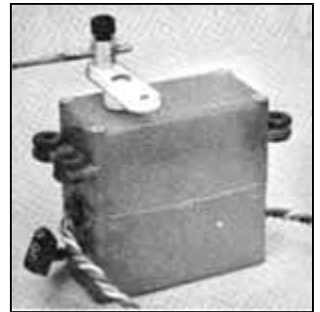

The SIGSH184 or Goldberg Snap'R Keeper can be installed on a wire push rod after it is bent, due to the design of the body of the fitting.



You should decide on which type of fittings you will use in the case of the cable pushrods and have them on hand during fitting construction because the type chosen will affect the location of the pushrod exit holes through the firewall, etc. The balsa pushrods to the rudder and elevator are not limited as to location and can be adapted to any of the types of connectors shown without preliminary planning of exact position.

COVERING AND FINISHING

IMPORTANT:

Don't skip covering the fuselage and tail just because they are solid wood. Painting them without covering first is not enough. They will be much more resistant to splitting and breaking on hard impacts if they are covered with something - Sig Silk, Silkspan, Sig Silray, Sig Koverall or iron-on covering material.

The manufacturer's directions for applying iron-on coverings are packed with the material. Follow these closely, for different types of covering have different iron-on temperatures and techniques of application.

Whatever kind of covering you desire to use, it will not conceal a rough framework. Sand carefully with fine sandpaper before beginning to cover.

Covering With Silk, Silkspan, or Silray

NOTE: The following photos show another model, but the covering method is the same. Sig Koverall is applied dry but is doped on in the same manner as shown. Shrink with heat. See directions on the Koverall package.

Although we refer to silk in the directions, all of these coverings are applied wet in the same manner as follows: Brush an unthinned or very lightly thinned coat of clear Sig Supercoat or Sig Lite-Coat Dope over all parts of the framework that will contact the covering. When dry, resand with fine sandpaper, to remove any fuzz or raised grain. Brush on a second coat and sand again.

The bottom of the wing is a good place to start covering. Cut a piece of material about 1/2" larger all around than half of the wing, with the grain running lengthwise. (The grain of woven materials runs parallel to the finished bias edge.) Some builders next dip the piece in water and apply it to the wing. I find that the silk sticks together and takes a lot of pulling and smoothing to get it in place so we do it a bit differently as shown in the photo.

Pin the dry covering in place and "paint" the water on with a brush.

Go around the edges, pulling out wrinkles and stretching the material smooth. You need not pull it up drum tight, in fact going to this extreme is not advisable. Just pull out all of the wrinkles. Use pins, if necessary, to hold the silk smooth, though wet silk usually stays in place without too much pinning. We like to fasten one end - in this case the center joint of the wing - pretty firmly with pins so that you can pull against this anchored end in stretching the silk the long way.



Brush around the outside edge of the stretched silk with clear dope. The dope will soak through the material and adhere to the dope already dried into the framework. Allow to dry.

Trim off the edges with a sharp blade. We find that a thin double-edged razor blade is ideal for this, but a single-edged blade does okay and you can't cut your fingers on it. On the bottom, trim off flush with the wing all the way around. Go over any rough areas or places that have not stuck down properly with more dope and press the loose spots down as the dope is drying and getting stickier.

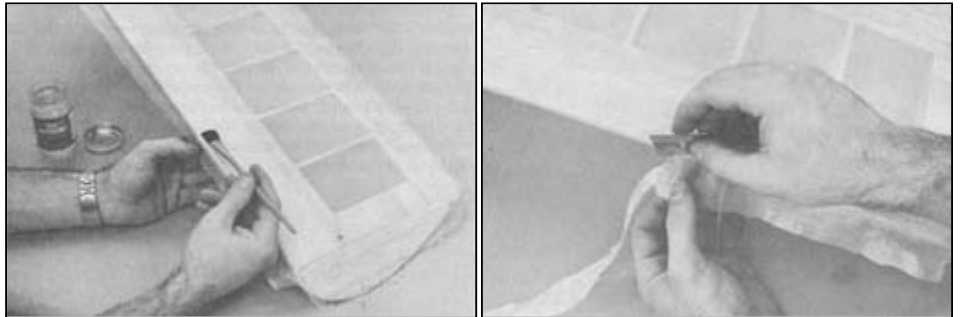

The top half is done in identical fashion except that the silk should be brought down over the edges instead of being trimmed off flush. On the front, lap the silk over the edge of the bottom, over-lapping about 1/8". At the back, bring the material down over the back edge of the trailing edge but do not lap it over the bottom covering.

Use the same process on the tail section and fuselage.



Allow the water to dry out of the wood before applying the first full coat of clear dope. On the open framework area on the wing, brush the dope on sparingly. If too much is applied, the dope will be rubbed through the material and will run down the surface on the inside and form a puddle. When these puddles dry, the large amounts of dope solids in them cause more shrinkage than the rest of the covering and a scarred area results. So apply dope very lightly the first time over. A second coat will seal most of the pores of the material and from this point, running through will not be a problem.

Use one or two coats of regular Supercoat clear on the wing to shrink the covering. After that, unless the covering is still not tight and unwrinkled, Sig Lite-Coat low shrink clear dope is recommended to help prevent warping. The solid wood fuselage and tail can have Sig Lite-Coat from the beginning if desired. Sig Supercoat Color Dope has low shrink qualities.

A third coat of clear should provide a good base for color. Sand lightly when dry with 220 grit 3-M Tri-M-lte no-load paper. Don't bear down on the edges of the ribs or the silk fibers will be cut through. The color dope may be brushed or sprayed.

Supercoat Color Dope should be thinned with 10% or more Supercoat Thinner for brushing. This helps prevent brush marks and gives smoother coats. Flow on wet coats and avoid rebrushing back over an area already painted. For spraying, thin dope about 50 - 50. Add more thinner if the dope does not go on evenly.

If high humidity causes the dope to "blush" or turn white, the test way to handle this problem is to wait until the humidity situation improves and apply another coat of dope. This will eliminate the blush. If it is necessary to dope during high humidity, Sig Retarder may be used in place of part of the Supercoat Thinner (amount depends on the humidity) to reduce the tendency to blush.

Painting the entire model white is recommended for a good color base, particularly when white is part of the color scheme. Color coats can be sanded with 360 Tri-M-Ite or 400 or finer wet paper. When using masking tape for trimming, seal the edge with a coat of clear dope to prevent the color dope from bleeding under the edge. Don't leave the masking tape on any longer than necessary. The longer it is on, the harder it sticks.

Complete the job with several sprayed coats of clear over the color scheme. This seals the colors and adds gloss. For a smooth, realistic finish the final coat may be rubbed down with Sig Rubbing Compound. For best results, it is not a good idea to try to mix different brands of paint. Use SIG products from the start.

A CURE FOR FUSELAGE WARPING

You may have noticed when a piece of balsa is doped on one side and not the other, it will curl. The same thing can happen on the fuselage sides, under the wing opening, particularly when you put on a number of coats. (The rest of the fuselage will not show this effect to any extent because it is four sided and cannot distort.) The effect isn't noticeable until after full cure of the dope and aging, which may take several months. To prevent this from happening, give the inside fuselage a coat of dope every time you give the outside a coat. This has an added advantage in making the cabin area fuel proof. In addition, when the hardwood servo mounts are installed, have them a little over-long so that the cabin sides are bulged slightly outward.

Finishing The Plastic Cowl

The plastic parts should be sanded to remove the gloss before they are painted. Don't use coarse sandpaper, which can cut deep scratches. These scratches may open up during doping (which softens the plastic) and become more noticeable. Instead use something like 220 3-M Tri-M-Ite no load silicon paper to start and polish down with 360 Tri-M-Ite or 400 wet paper before color doping.

The plastic cowling and wheel covers may be painted with Sig Supercoat Dope. Care should be used not to apply heavy, wet coats of dope. Put on light coats and allow them to dry thoroughly before applying a second coat. A spray gun is a good method of getting a good finish with a minimum amount of dope. Be especially careful with spray cans not to wet the plastic too much. Spray several light dusting coats with adequate drying time allowed. Plastic may also be painted with Sig Plastinamel, Sig Skybrite, K&B Super Pox, Hobby epoxy or DuPont Dulux Enamel. Don't use other paints without testing them first on scrap plastic.

Painting The Canopy

We recommend Sig Plastinamel for painting the framing outlines on the canopy. Dope is very difficult to use on canopy plastic because of its warping action. Epoxy paint can be used, but it does not stick on the plastic quite as well as Plastinamel. Sanding the gloss off the plastic will help adhesion. Other enamels and plastic paints can be used, but test in advance on scrap, because no assurance can be given for other types.

Control Movements

Various brands of servos can give different control movement direction and amounts of travel. For this reason, follow the measurements below when setting the Kavalier up for flight rather than any particular hole drawn on the full-size plan or visible in a Kavalier picture. Shift the R/C link to whatever hole will produce the amount of movement shown in the drawings below. Measurements are made at the trailing edge of the control surface.

The control measurements below are suggested as a beginning. Test flights may indicate a need for more or less movement, depending on individual model differences, C. G. location, your personal preferences, etc.

For training purposes, do not carry excessive elevator movement. Use only enough to properly perform a nice sized loop. Over control with excessive movement can get a novice in trouble. After you are more expert, additional movement can be used, if desired, for quick snaps and other violent maneuvers.

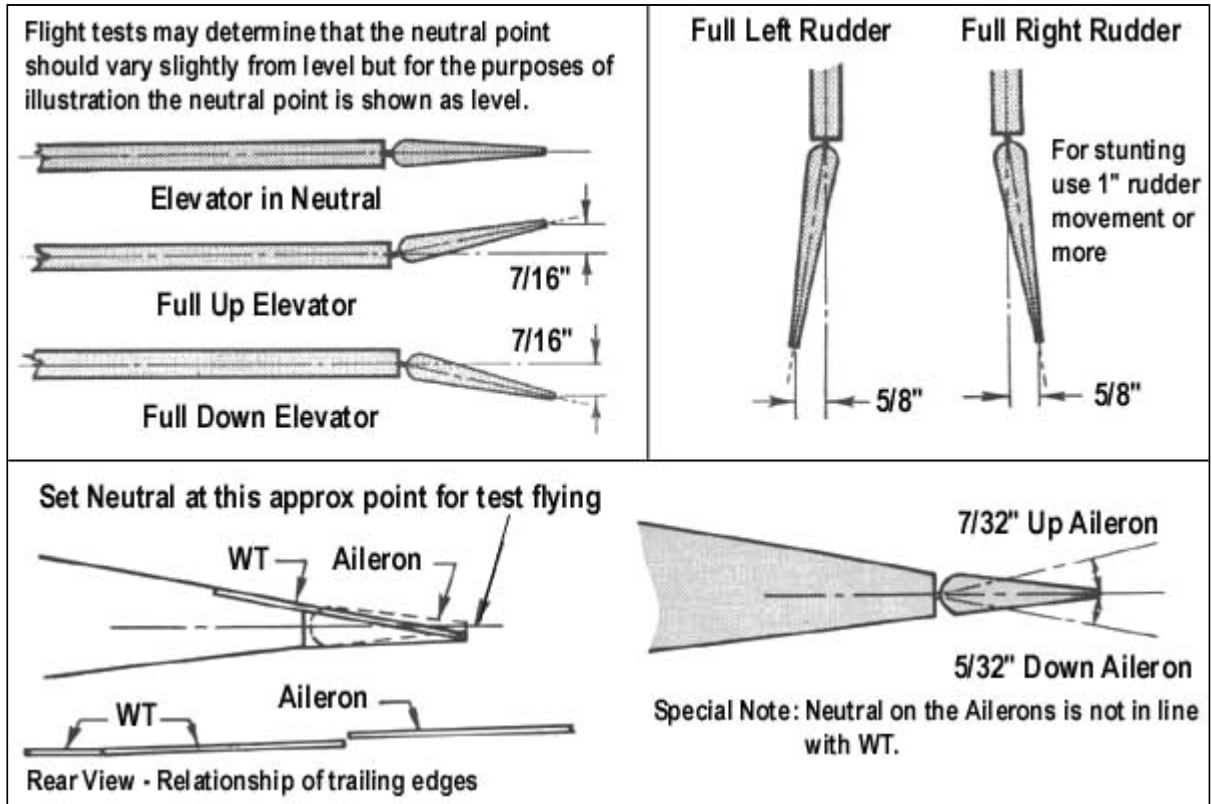

Balancing

The recommended Center of Gravity locations are shown on the side view on the full size plan. Extend these marks to the bottom of the wing at the tips. (A handy way is to stick a piece of masking tape on each wing and mark the positions on it.) For the first test flight, balance the Kavalier by suspending it on the finger tips placed on the bottom of the wing on the first mark. Balance with an empty fuel tank, but with all other equipment installed and the model completely finished and painted. Add lead to the nose, if necessary, to get the model to hang level. Be sure and fasten the weight securely. Do not attempt flight tail heavy.

The "Test Flying" position is on the nose heavy side. When slightly nose heavy, the model is more stable and less likely to stall or snap roll from over-elevating. It also cuts down reaction of the model to control movements and this is good during test and practice flights, to help prevent overcontrolling. After the model has been test flown and initial trimming accomplished you will want a little quicker response. Move the balance back to the "Sport Flying" position.

Some aerobatic capability is sacrificed with the two forward C. G. positions, so for making deliberate snap rolls and spins a position farther back may be required. Move the C. G. back slowly and check results and control response in the air at a good altitude. Don't move the C. G. back any farther than necessary. The "Aerobatics" balance point should be considered the rear limit and moving it back any farther is not recommended unless you are an expert flier, with a purpose for doing so.

FLYING

IMPORTANT:

The Kavalier is not a basic trainer. If you have no previous RC flying experience you cannot successfully fly a responsive design like the Kavalier, particularly on the test flights. A basic trainer, such as the Sig Kadet, should be used for a number of hours before attempting to fly the Kavalier by yourself.

It is recommended that novice pilots should not attempt to fly the Kavalier without the assistance of an experienced pilot. Contact the local model club or ask your hobby dealer for the names of good fliers and a suitable location for flying.

Many hours of work are involved in the construction of a model and it can all be lost in a moment of beginner's indecision. A skilled flier can help you get past the first critical test and trimming flights without damage to the model and give instruction in proper control.

Be certain to carefully range check your radio equipment and see how it operates with the engine running before attempting test flights. A lot of problems can be avoided if the engine has been well broken-in and the idle adjustment perfected on a test block or in another airplane before installation in the model.

Takeoffs with the Kavalier from grass fields are easily made if the grass is not too long or the ground too rough. Generally a lot of elevator application is required for liftoff. Be prepared to relax control pressure partially after becoming airborne so the climbout will not be too steep. On surfaced or smooth dirt runways less application of elevator will be needed.

If a good, smooth take-off surface is not available, the model can be hand launched by the pilot's assistant. (Do not attempt to hand launch by yourself, instant action on the transmitter may be required.) Holding the front part of the fuselage with the left hand and under the tail with the right, run into the wind at a fast trot and thrust the model forward with the nose slightly up in a spear throwing motion. It is not necessary to achieve a lot of velocity in the launch-it is more important that it be released smoothly and with the wings level. The model may dip slightly and then should begin climbing at a slight angle. If it does not begin to climb after about fifty feet of flight, apply a small amount of up elevator to lift the nose.



Use the ailerons to keep the wings level and headed straight into the wind until about seventy-five feet of altitude is obtained. Keep first turns gentle and not steeply banked. Stay up wind of the transmitter. Use trim levers on your radio equipment where necessary to obtain straight and level flight with the control sticks in neutral position but don't attempt to make these adjustments until the model is at a good altitude. Throttle back at altitude to find out the model characteristics in a gliding condition so that some indication is seen of what to expect during the landing approach. It is a good idea to make several practice landing approaches at a good altitude to get the feel of the model for this approaching critical maneuver. Make your final and complete landing approach while your engine still has plenty of fuel remaining so that the engine is not liable to stop before completion of the flight. This will allow application of power if the approach is undershot. Notice the percentage of missed landings at an R/C flying field. Those undershot greatly outnumber those missed by overshooting. So, if an approach that looks a little high is maintained, chances are good that a spotlanding can be made.

After each test flight, readjust the R/C clevis links on the pushrods so that the trim levers on the transmitter can be returned to a neutral position. It will take several flights before exact trim is established on all axis of flight.

© Copyright SIG Mfg. Co., Inc.

SIG MFG. CO., INC.....Montezuma, Iowa 50171-0520

LIMIT OF LIABILITY:

In use of our products, Sig Mfg. Co.'s only obligation shall be to replace such quantity of the product proven to be defective. User shall determine the suitability of the product for his or her intended use and shall assume all risk and liability in connection therewith.