

# KADET MARK II



 SIG

## BUILDING AND FLYING INSTRUCTIONS

CRAFTMAN'S KIT SIGRC49

Since its introduction to the modeling scene in 1973, the Kadet series has set the industry standard for R/C trainers. More people have learned to fly with a Kadet than any other trainer in history. Its popularity led directly to the development of the Kadet Junior, the Kadet Senior, and the Kadet Seniorita. The Kadet Mark II is a refined development of the famed Kadet Mark I trainer and is intended specially for 4-channel flight training. If you have the assistance of a skilled R/C flier during the initial test and training flights, then full 4-channel control with ailerons can be used from the beginning, although some R/C instructors feel it is best to get in some flying on rudder first before advancing to ailerons. If no expert assistance is available for first flights, our recommendation is that you begin with 3 channels only, with rudder as the main turning control instead of ailerons. Then, after you gain confidence, go to 4-channel control with ailerons.



Be sure to read the "Basics of Radio Control" booklet included with this kit. It will provide you with the basic knowledge that you will need to be successful in the challenging hobby of radio controlled model aircraft. From the selection of radio equipment to that first exciting flight, the "Basics of Radio Control" will be invaluable to beginners and more experienced pilots as well.

### Radio Equipment Requirements

Selection of radio equipment should be based on the amount of money you wish to spend, the type of airplanes you intend to fly, and your future goals in the hobby. Although the Kadet can be flown on two, three, or four channels, a good four-channel radio will last for years and can be used in more advanced models when your flying skills improve. Be certain that the frequency transmitted by your radio is approved for use in R/C model aircraft. Using a frequency assigned to surface vehicles (cars, boats) not only endangers your model to interference from model car or boat drivers (who may not even be in sight), it is also against the law.

## Engine Size

We are of the opinion that R/C trainers should have adequate power for such things as grass field takeoffs, beating their way upwind, etc. For cruising around and learning to fly, throttle back with the knowledge that power is available when needed. Therefore, we generally think that a .29 to .40 size engine is best for the Mark II. If a .25 is used, the model should be kept light, without a lot of heavy finish. A .25 would also serve adequately on two or three channels. Remember that a muffler will reduce engine power and allowance should be made for this. If you live at high altitude, engines will not develop power equivalent to that delivered at sea level.

### A Note on Mufflers

Unless you are one of the lucky few who has a flying site miles away from any sort of civilization, you should use an effective muffler on your engine. The sound of an unmuffled R/C engine can be annoying to anyone within earshot. The last thing you want to do is turn potentially friendly neighbors into enemies that could, in the worst case, go so far as to have all flying activity at your field shut down.

Most manufacturers supply good mufflers with their engines. If for some reason you have an engine without a muffler, or the supplied muffler doesn't fit the Kadet, you can use one of the many aftermarket mufflers. Tatone's Extended Peace Pipe muffler, Mac's Scotsman or Expansion mufflers, DuBro's Muff-I-Aire and Mini-Muff-I-Aire, as well as others will all fit the Kadet.

## Recommended Glues

There are so many different glues available today for model construction that it can be confusing for the newcomer. To simplify matters, most glues can be classified as one of these basic types:

1. Fast-drying cyanoacrylate adhesives (CA) or "super glues" such as SIG CA, Hot Stuff, Jet, etc .....
2. Easy-to-use water-base wood glues such as SIG-BOND (yellow) and SIG SUPER-WELD (white).
3. Super strong two-part epoxy glues such as SIG KWIK-SET (5-minute cure) and SIG EPOXY (3-hour cure).
4. Traditional solvent-base model cements such as SIG-MENT.

Each of these types has different characteristics and advantages. Often times, the choice of which type to use is strictly a matter of personal preference based on your prior experience with a previous model. Some of the steps in the book call out the type of glue to use for that particular assembly. In other areas you can use your own judgement as to which type is best suited to the purpose and to your building schedule. For general construction of the Kadet Mark II, we recommend the use of cyanoacrylate adhesives or SIG-BOND. Even if you plan to use CA, SIGBOND will come in handy for gluing parts such as wing leading edge sheeting or center sheeting where you need to apply glue to several parts in one operation. You should also have on hand some epoxy glue, both 5-minute and slow dry, for areas subject to high stress or joints involving metal parts.

Cyanoacrylate adhesives have become very popular with modelers because of their fast drying times. With CA, you can virtually build a structure from start to finish without having to wait for the glue to dry. Most brands, including SIG CA, come in three different viscosities: thin, medium, and thick.

- Thin CA has a watery consistency and uses capillary action to penetrate and soak into a joint. Since it is so thin and dries so quickly, the parts to be joined must be in firm contact with each other before application of the glue. Use thin CA for the initial assembly of balsa parts over the plans.
- Medium viscosity CA (SIG CA PLUS) can also be used for initial assembly in the same manner as the thin, but it takes a little longer to dry. Joints made initially with thin CA should be reglued with medium CA for additional strength. Medium CA should also be used when gluing plywood, spruce, or hardwoods.
- Thick CA is good for gluing doublers to fuselages and forming fillets in high stress areas.

The drying time for all CA's can be speeded up by spraying an accelerator (such as SIG KWIK-SHOT) right on the joint.

### CAUTION:

Some people have experienced allergic reactions when exposed to epoxy or cyanoacrylate glues. This is very rare. However, it is always important that such glues, and also paints, thinners, and solvents, be used with adequate ventilation to carry fumes away.

## You Can't Get Along Without A Good Sanding Block

An assortment of different size sanding blocks are indispensable tools for model construction. A good general purpose block can be made by wrapping a 9" x 11" sheet of sandpaper around a piece of hardwood or plywood. Use three screws along one edge to hold the overlapped ends of the sandpaper. Put 80-grit paper on the block during general construction. Switch to 220 grit paper for final sanding just before covering.

In addition to the large block, there are places where a smaller one is handy. (See photos 17 and 24.) Also, a sandpaper "file" can be made by gluing sandpaper to a flat spruce stick for working in tight places.

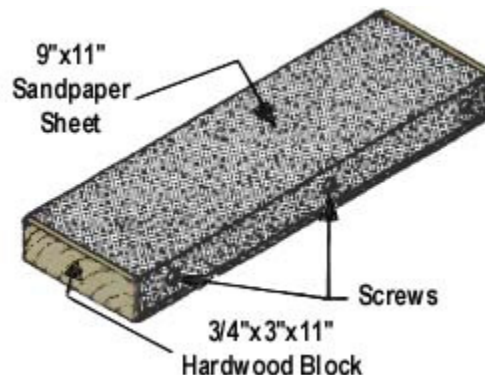

## Cutting Out Printed Parts

A jig saw is best for this job. Cut just outside the lines, leaving all of the black line on the part. When fitting the part into place on the model, use the sanding block to bring the edges to an exact fit. If a modeling knife is used to cut out the parts, don't cut too close to the lines - leave some extra wood outside the line and finish the edge with the sanding block.

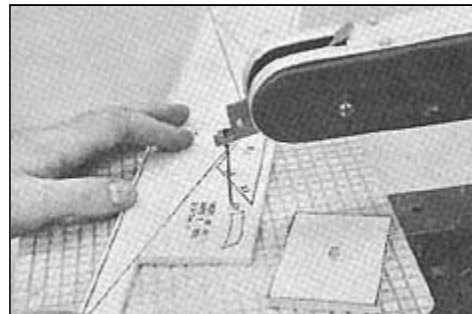

## About The Building Sequence

The quickest and most efficient way to complete a model is to work on several pieces at the same time. While the glue is drying on one section, you can start on or proceed with another part. Work can even go forward on several sections of the same assembly at the same time, such as the front and rear sections of the fuselage.

Keep in mind that the number sequence used in these instructions was chosen as the best way to explain the building of each major component and is not intended to be followed in exact one-two-three fashion. Start on the wing at No.1 and after doing as many steps as is convenient, flip over to "FUSELAGE CONSTRUCTION" and do a step or two there, then over to "TAIL CONSTRUCTION" and so forth. You will, of course, arrive at points where you can go no farther until another component is available. Plan ahead, read the instructions completely and study the full size plans before beginning construction.

## Notes Before Beginning Construction

Any references to right or left refers to your right or left as if you were seated in the cockpit.

To build good flying models, you need a good straight building board. Crooked models don't fly well! The building board can be a table, a workbench, a reject "door core" from the lumber yard, or whatever - as long as it is perfectly flat and untwisted. Cover the top surface of the building board with a piece of celotex-type wall board or foam board, into which pins can be easily pushed. Don't hesitate to use plenty of pins during assembly to hold drying parts in correct position.

When pinning and gluing parts directly over the full-size plans, cover the plan with wax paper or plastic kitchen wrap to prevent gluing the parts to the plans.

Don't use a ball point pen for making marks on the model during construction. If not sanded off, these ink marks will show through the model's final finish. Use a pencil instead of a pen.

Pins can be pushed through all pieces in the kit without any lasting damage. Don't be afraid to use plenty of pins when planking with SIG-BOND.

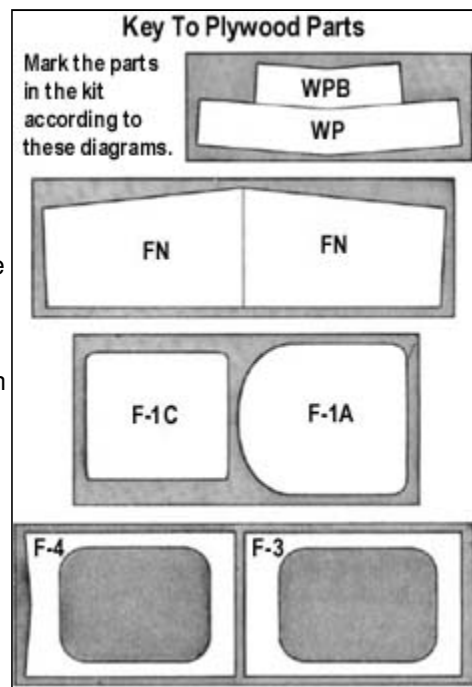

Leave all die-cut parts in the sheets until needed in construction. Then remove the pieces from the sheets carefully. If difficulty is encountered, do not force the part from the sheet - use a modeling knife to cut it free.

The die-cut balsa wing ribs are identified within the wing construction section. The die-cut plywood parts can be identified using the plans and the "Key To Plywood Parts". Mark the identification numbers on the corresponding parts before removing them from the die-cut sheets.

All of the other parts can be identified by the "Complete Kit Parts List". Sort the different sizes of sticks and sheets into individual piles to avoid confusion during building. Cut all long pieces of balsa first, followed by medium lengths, before cutting up any full-length strips into short pieces. Pick out the two hardest 1/4" sq. balsa sticks to use as pushrods.

NOTE: Save any scrap balsa and plywood until the model is completely done. Some of it may be called for during construction.

<b>COMPLETE KIT PARTS LIST</b>			
<b>Printed Balsa Sheets</b>			
1 3/32"x6"x36" SHEET #1; Left Fuse Side, FF, DGF, FP, WT	1 3/32"x6"x36" SHEET #2; Right Fuse Side, FF; F-1B, DGF, WT	1 1/4"x3"x18" SHEET #3; R-1, R-2, R-3, DG, FB	1 3/32"x3"x4-1/2" SHEET #4, WF, F-2
<b>Die-Cut Balsa Sheets</b>			
4 3/32"x3"x18" SHEET #5; W2 Wing Ribs	1 3/32"x3"x18" SHEET #6; W1 Wing Ribs		
<b>Sheet Balsa</b>			
2 1/16"x3"x36" Stabilizer Sheeting (or 3 ea. 1/16"x3"x24")	3 3/32"x1-1/2"x30" Trailing Edge Bottom Planking	8 3/32"x3"x30" Planking for Wing Leading Edge, Center Section, Wingtip, and Fuselage Top and Bottom	1 1/8"x3"x24" Cabin Doublers, First Piece Aft of Lite-Ply Floor
1 1/8"x3-9/16"x9" Spar Web Material	1 1/4"x3"x3-5/16" LGB		
<b>Block Balsa</b>			
2 3/4"x2"x3" Wing Fairing Blocks	1 3/4"x4"x3-1/4" Windshield Block WS		
<b>Stick Balsa</b>			
4 3/32"x3/16"x36" Capstrips	2 3/32"x1"x36" Trailing Edge Top Planking	4 1/8"x3/8"x36" Stabilizer Frame	4 13/64"x13/64"x36" Rear Wing Spar, Trailing Edge Spar, Fuselage Stringers
8 1/4"x1/4"x36" Top Front Wing Spars, Fuselage Structure, Crosspieces	1 1/4"x1/2"x12" Fuselage Structure (Top of cabin, one fuselage side.)	3 1/4"x1/2"x36" Bottom Front Wing Spars, Spar Doublers, Fuselage Structure	1 3/4"xTriangle x6" Firewall Braces
<b>Special Shaped Balsa</b>			
2 3/16"x3/8"x1/4"x28" Leading Edge	1 1/4"x2"x8" Tapered Sheet for Rudder	1 1/4"x2"x24" Tapered Sheet for Elevator	1 5/16"x1-1/8"x7" Center Section Trailing Edge
2 5/16"x1-1/8"x24" Ailerons	2 3/8"x3/4"x3" FT (Sawn Wedges)		
<b>Hardwood</b>			
2 1/4" dia.x5-1/4" Wing Hold-On Dowels	1 3/8"x3/8"x4" Basswood Cowl Mounting Block Material		
<b>Die-Cut Plywood</b>			
1 3/32"x3"x7-1/2" Dihedral Braces WP and WPB	1 3/32"x4-1/2"x9-1/4" Firewall Parts F-1A and F-1C	1 1/8"x3-3/4"x11-1/4" FN Nose Doublers	1 1/8"x12-1/2"x4-1/2" Cabin Formers F-3 and F-4
<b>Sawn Plywood</b>			
1 3/32"x2-1/2"x3-1/2"; LGP Landing Gear Plate	1 1/8"x4"x12"; Cabin Bottom		
<b>Miscellaneous</b>			
1 .090x1-1/2"x15-9/16" Formed Aluminum Main Landing Gear	1 Formed Nose Gear Wire	1 Left-Hand Formed Aileron Horn with Brass Bearing	1 Right-Hand Formed Aileron Horn with Brass Bearing
1 Injection Molded Plastic Cowling	1 2"x24" Glass Cloth Tape for Wing Center Joint	1 Full-Size Printed Plan	1 36 Page Photo-Illustrated Instruction Booklet
1 "Basics of Radio Control" Booklet	1 3"x4-1/2" Stik-Tite Decal		

Hardware			
4 4-40x3/8" Mounting Bolts for Nose Gear Bearing	4 4-40x3/4" Mounting Bolts for Main Landing Gear	4 6-32x3/4" Mounting Bolts for Engine Mounts	2 8-32x1-1/2" Mounting Bolts for Wheel Axles
4 No.2x1/2" Sheet Metal Screws for Control Horns	4 No.4x1/2" Sheet Metal Screws for Cowling	1 6-32x1/4" Self-Tapping Bolt for Steering Arm	4 8-32 Hex Nuts for Axle Bolts
8 4-40 Blind Nuts for Nose Gear Bearing and Landing Gear	4 6-32 Blind Nuts for Engine Mounts	2 Molded Glass Filled Engine Mounts	1 5-32" Molded Nylon Nose Gear Bearing
1 5/32" Molded Nylon Nose Gear Steering Arm with Brass Insert	1 Medium Molded Nylon Control Horn for Rudder	1 Large Molded Nylon Control Horn for Elevator	2 4-40 Molded Nylon Aileron Connectors
4 2-56x10" Threaded RIC Rods (2/Ailerons, 1/rudder, 1/elevator)	4 2-56 R/C Links (may be metal or nylon)	12 Easy Hinges	1 Push rod Connector Assembly

## WING CONSTRUCTION

1. Cut 9 1/16" off the end of each of two pieces 1/4"x1/2"x36" main spar stock. Glue these pieces to the remainder as center section spar doublers. Cut two pieces of 1/4" square stock 28 5/8" long. Cut two other pieces 9 1/16" long. Glue the 9 1/16" pieces to the 28 5/8" pieces in the same way as shown in Picture 1 of the 1/4"x1/2" bottom front spar.

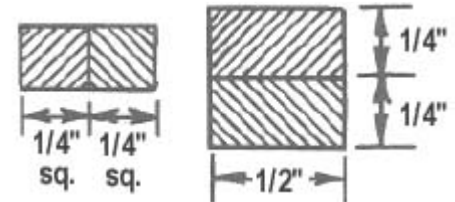

2. These cross section drawings show the placement of the doublers.
3. Place two of the 3/32"x3"x36" pieces of wing sheeting wood on the plan with one end on the wing center line. Trim off the other end of the wood at the outer edge of the last wing rib. Save the scrap pieces.
4. Place the two 3/32"x1-1/2"x36" pieces of wing sheeting wood on the plan with one end on the wing center line. Trim off the other end of the wood at the outer edge of the last wing rib. Save the scrap pieces.

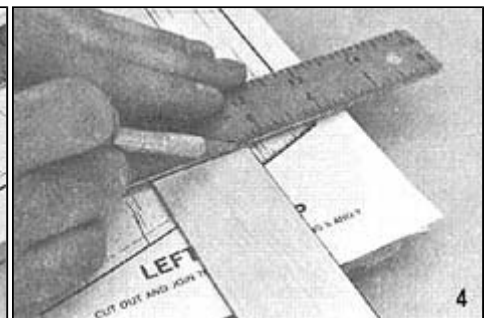
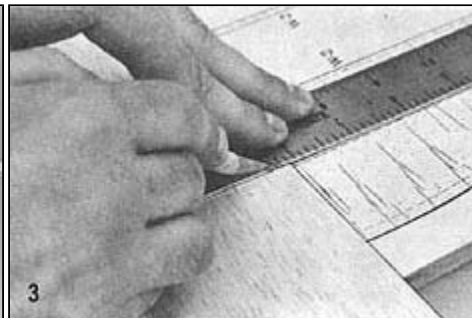
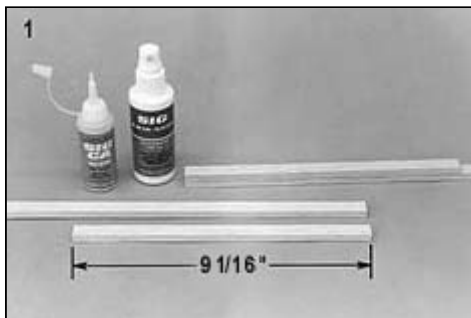

5.
  - a. Pin one of the 3" wide pieces to the plan.
  - b. Pin one of the 1 1/2" wide pieces to the plan

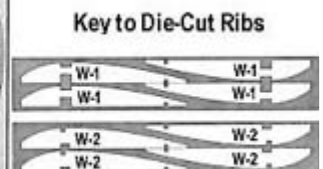

6.
  - a. Use some end scrap to make the tip planked section. (Be sure you first cut long pieces from the scrap for the center section before using the remaining scrap for the tip.)
  - b. Glue the seams between these pieces when pinning them down to the plan.
  - c. Cut cap strips to fit between the sheets.

### About Wing Dihedral and Ailerons

We receive occasional comments that the Kadet appears to have too much dihedral for the ailerons to work effectively. While individual builders have reduced the dihedral on their own initiative (and the Kadet flies OK with less dihedral), we do not believe this course is either advisable or necessary for beginners. Reducing the dihedral will make the model roll easier but it also decreases hands-off stability and this is not a good situation for a novice RC flier. During the first periods of learning to fly RC, beginners should not attempt to roll their Kadet but should concentrate on practicing good turns. When the student pilot can easily handle the Kadet in take-off, level flight, and landing, only then should stunts be attempted.

7. Leave the center section bottom planking pieces until later, after the wing is assembled.

8. Stack all of the ribs and pin them together. Use scrap wood in the spar holes to align the ribs accurately. Sand the ribs even. Even the front and back also. The rib sanding process may reduce the height of the ribs slightly and thereby reduce the height of the spar slots. Before unpinning the rib stack, check the spar slots with a piece of spar wood. Deepen the slot, if necessary, so that the spar will go completely into the ribs. Do not oversize the slots.

NOTE: The 3/16" sq. provided in the kit for the wing is intentionally slightly oversize to allow for shaping the trailing edge to correct airfoil contour. The 3/16" sq. can be confused with 1/4". Segregate the two sizes of sticks before cutting pieces from them.

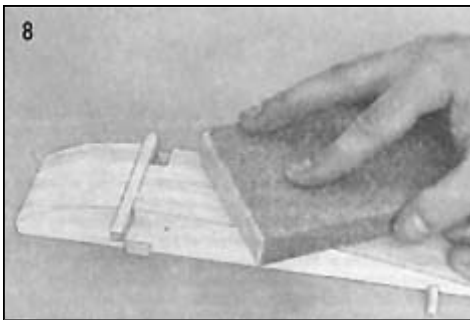
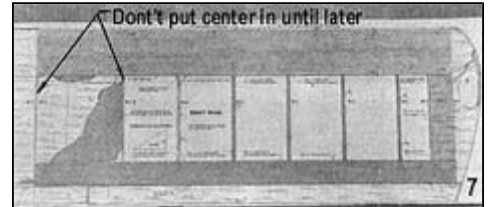
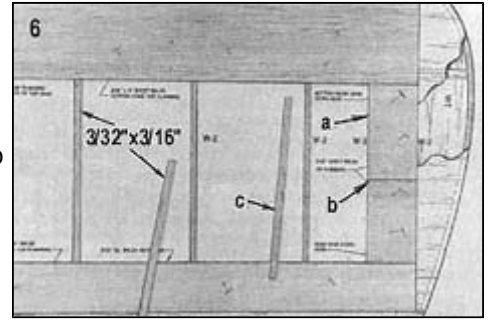

Pattern for W-1A

Make two W-1A ribs from two of the W-2 ribs by using this modification pattern to enlarge the front spar holes.

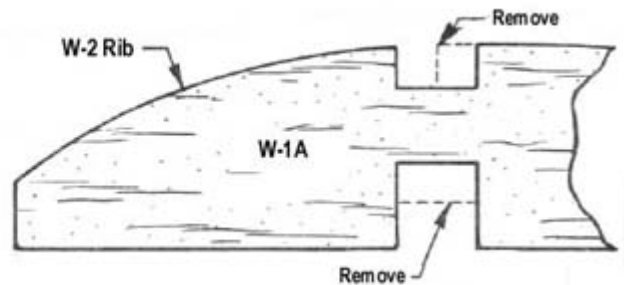

9. Four W-1 ribs are supplied on a die cut sheet. For the two W-1A ribs required, take two of the W-2 ribs and convert them to W-1A ribs by use of the pattern shown above.

10.
  - a. Pin and glue the front spar assembly previously done in Step 1 to the front bottom planking. Cut the spar to be the same length as the planking sheet.
  - b. Using several ribs as a locating guide so that the rear spar is correctly spaced to accept all of the ribs easily, pin and glue the 3/16" sq. rear spar on the rear bottom planking. Cut the spar to be the same length as the planking sheet.

11. Glue and pin the ribs in place. Glue them to the planking and cap strips as well as to the spars.

12. Using the dihedral gauge as a guide, glue the center W-1 rib to the spars and planking at a slight angle. Pin to hold it at this angle until the glue dries.

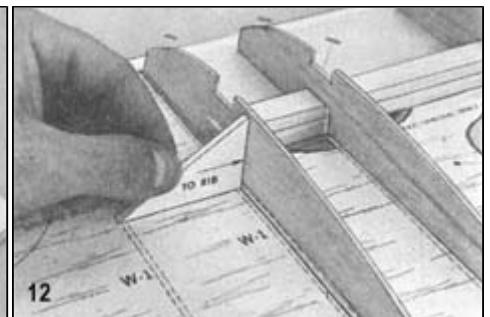
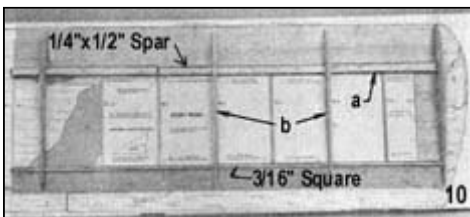

**Note About 3" Sheet Width**

Balsa sheet width varies from 3" to 3 1/16". Therefore the 1/4"x1/2" bottom spar may be entirely on the sheet or protruding off of it slightly, as shown in the step-by-step drawings that follow. This small variation in width causes no problem in the assembly of the wing.

NOTE: These diagrams are for reference only and are intended to aid your understanding of the wing construction.

13. Pin and glue the 3/16" sq. back edge of the wing on to the back of the ribs and to the planking.  
NOTE: At the tip end leave 3/16" square sticking out to be trimmed to fit the wing tip later in step 18.

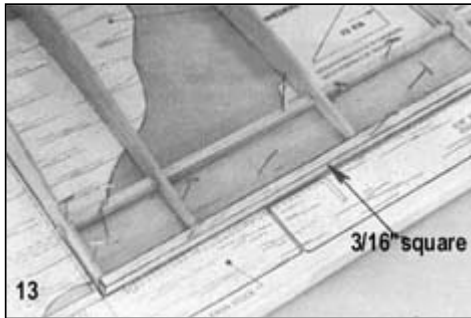

14. Pin and glue the 1/4"x3/8" special shaped leading edge in place on the front of the ribs and to the planking.  
NOTE: At the tip end leave the leading edge long enough to be trimmed later to fit the wing tip WT in step 18.

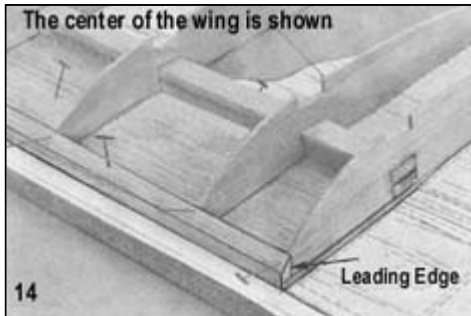

15. Cut out the WT wingtip pieces from the printed balsa sheets #1 and #2. Finish evenly to the outside line with a sanding block.

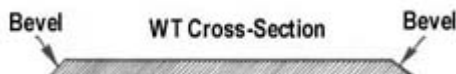

- 1 Glue the bottom spar and the rear spar at the same time- to the bottom planking sheets.

- 2 Glue the ribs in place on the spars and to the bottom planking and the cap strip.

- 3 Glue the shaped leading edge to the bottom planking.

- 4 Glue the 1/4" square top spar into the ribs.

- 5 Apply Sig-Bond to the leading edge ribs and top front spar. Pin and glue the planking to the leading edge first. Use plenty of pins.

- 6 Bend the planking sheet down to the ribs and the top front spar. Use pins to hold it down. If necessary, wet the top of the wood with a sponge to make it pliable. Don't use water unless required to get the wood in place.

- 7 Later, when the wing is completed and removed from the building board, shape the leading edge to airfoil contour.

### Leading Edge

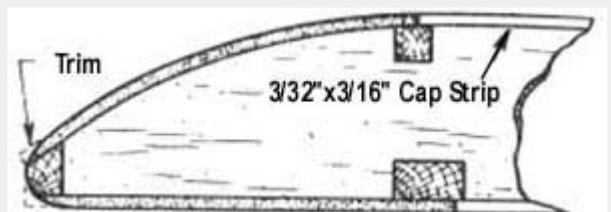
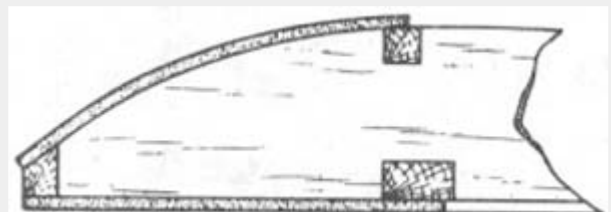
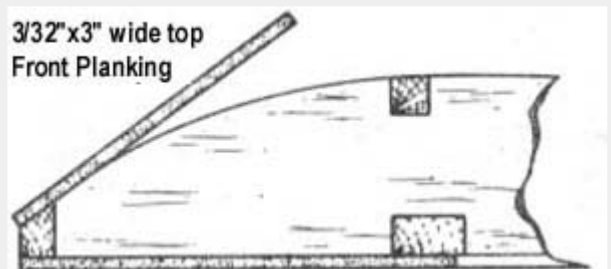
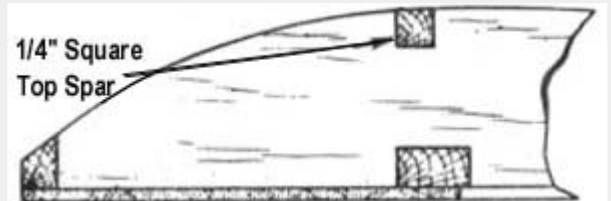
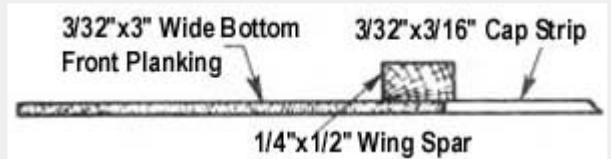

16. Trim a bevel on the top and bottom using the inside line of the gray shaded portion as a guide for cutting.

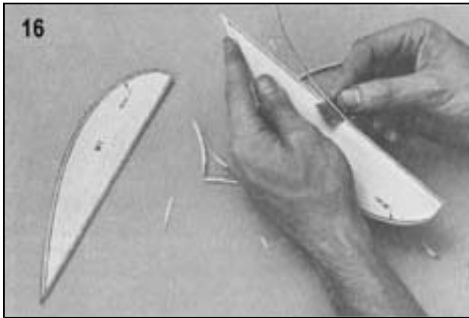

17. Finish the beveled edges with a small sanding block.

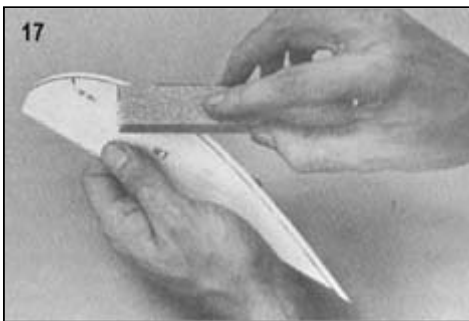

- 18.
- Use the Tip Guide pattern to set the angle of WT. If WT does not sit properly in place at this angle, sand to fit snugly against the rib and bottom planking.
  - Trim the end of the 3/16" sq. back edge of the wing to fit against WT.
  - Glue WT to the wing

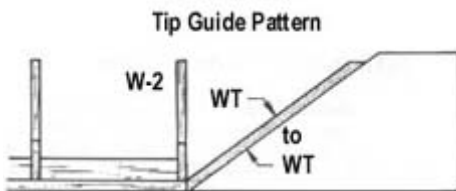

- The rear planking and the spar setup are done in the same manner as step one of the leading edge. Then glue the ribs to the spars, the bottom planking and the bottom cap strips.

### Trailing Edge

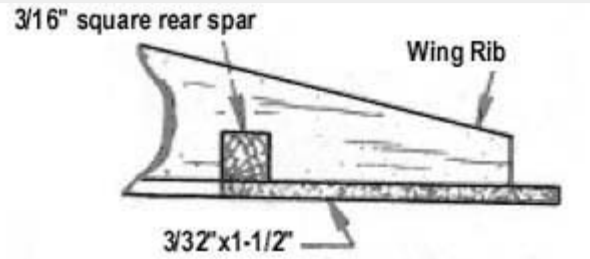

- Add the 3/16" square back edge of the wing, gluing it to the planking and the backs of the ribs.

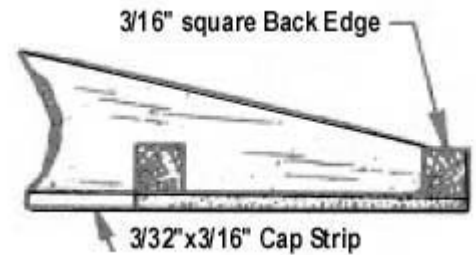

- Sand down the 3/16" square back edge of the wing to conform to the top line of the ribs.

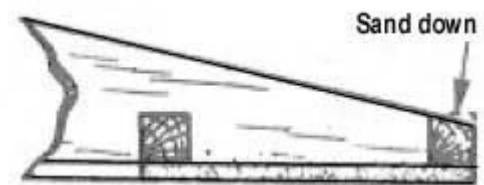

- Pin and glue the 3/32"x1" wide top rear planking in place on the ribs and the 3/16" square back.



- Complete the wing assembly by adding the top capstrips on all ribs which do not have planking on them.

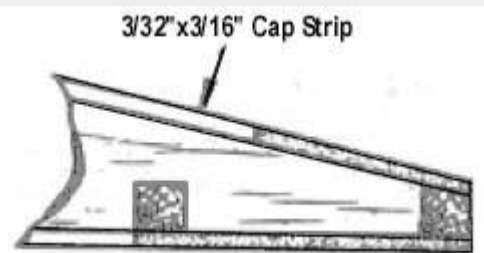

19. Using the prepared top spar (Paragraph 1), cut the end at an angle to fit against WT. (The Tip Guide can be used for this angle also.)

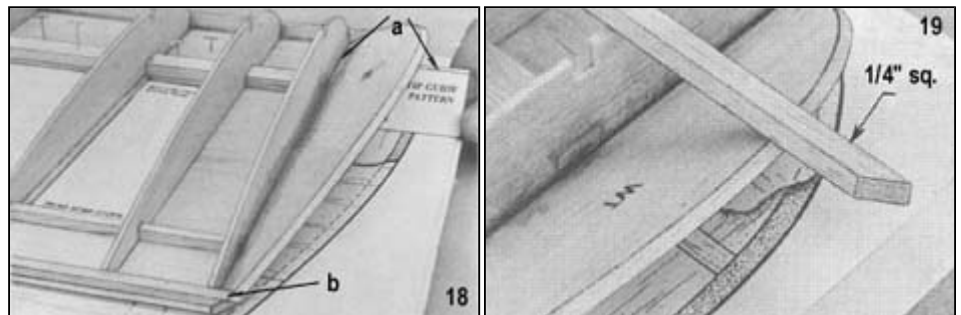



20. a. Glue the spar into the rib notches.  
b. Glue the angled end against WT.

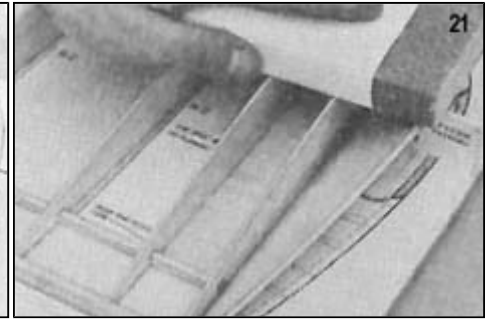
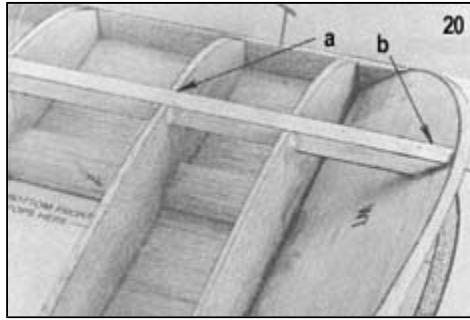

21. Sand the ribs and the bevel on WT to a good match. Use paper on the block to keep from cutting down the ribs while WT is being shaped.

22. Sand the rest of the wing lightly with a large block. Do not oversand.

23. A small sanding block is handy to touch up the ribs.

24. The 3/16" sq. back piece should be beveled slightly on the top to follow the wing contour.

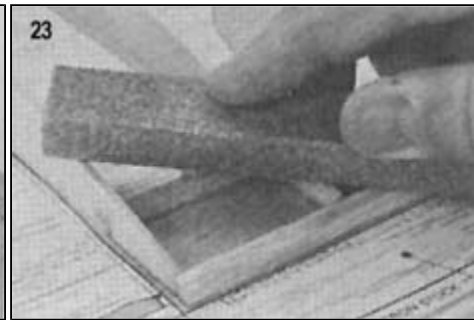

25. Cut seven 1-1/4" wide strips from the 1/8" x 3-9/16" x 9" balsa included in the kit.

26. Trim each piece of web to fit snugly between the ribs.

27. a. Use the odd piece for the narrow spaced ribs in the center.  
b. Glue the web pieces to the spars and to the bottom planking.  
c. Webbing ends here at the 4th rib from the center.

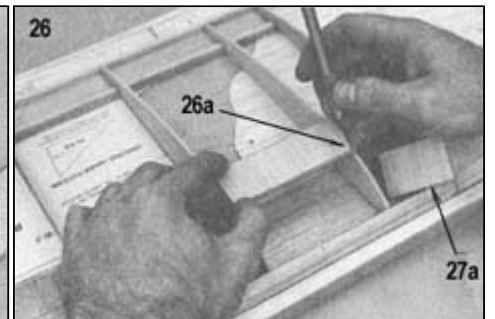
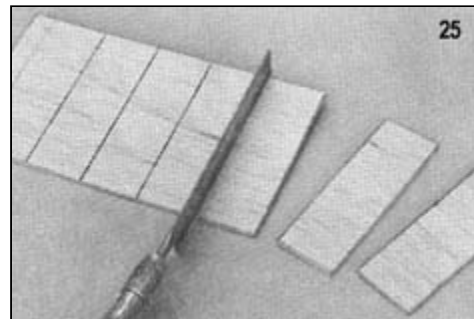

28. Trim the tops of the web pieces so that they are even with the top of the main spar.

29. Sand the web pieces smooth.

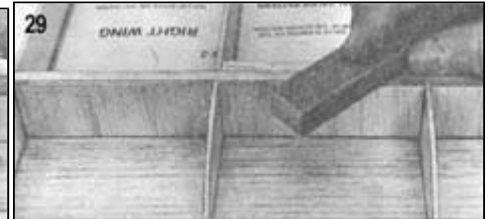
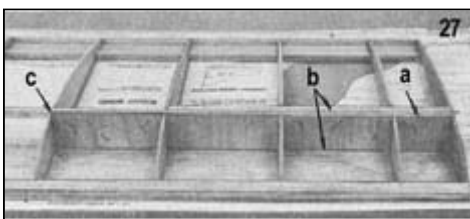

30. a. Glue the spar and web.  
b. Put glue on each rib between the spar and the leading edge and on the leading edge also.

31. Pin the leading edge 3/32"x3"x36" top planking sheet in place starting at the leading edge. Use plenty of pins to hold it to the ribs, the tip and the spar. If it will not easily bend in place from the leading edge to the spar, wet the top of the sheet with a cotton swab to make it more pliable and curl it into place. Don't wet it unless it is necessary.

32. Glue the 3/32"x1"x36" rear top planking sheet in place. Use the waste end for other planking.

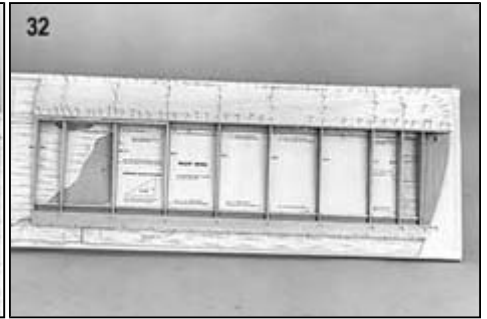
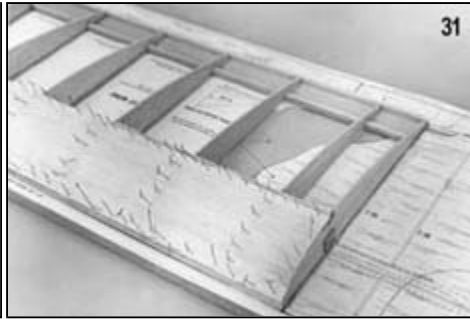

33. Add a piece of 3/32"x3"x36" planking sheet to the top of the wing tip.

34. Complete the wing tip planking by fitting pieces of 3/32" planking into the remaining opening.

- 35.
- a. Pin and glue the 3/32" x 3/16" cap strips onto the top of each rib.
  - b. The three center section ribs are not cap stripped.

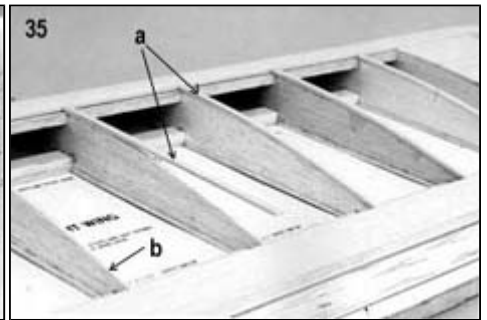
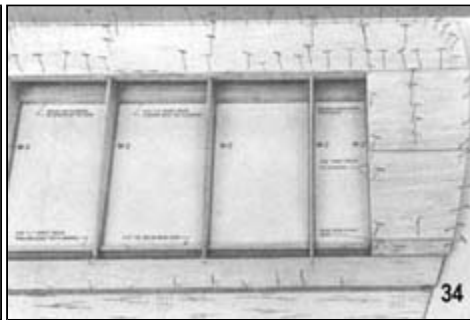
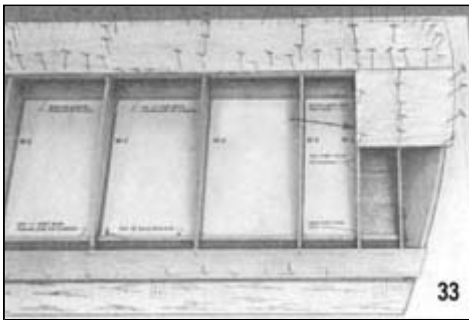

**NOTE:**

In preparing the Mark II for production, an improvement was made in wing center section construction, so your model will not look exactly like the prototype Mark II on the label.

36. Plank the center in the same way as the tip with 3/32" sheet.

37. Remove the wing from the board and trim off the planking scrap.

38. Sand the tip planking flush with WT.

39. Carve the leading edge to airfoil contour.

**NOTE:**

Some photos showing methods of construction are of other models, but the procedure is the same for the Kadet MK II.

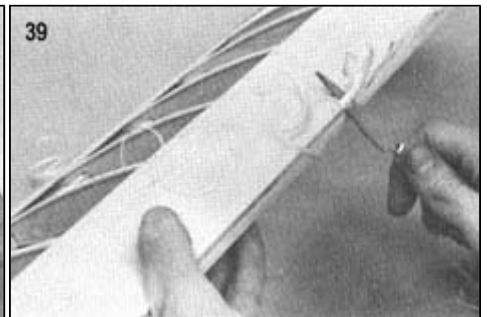
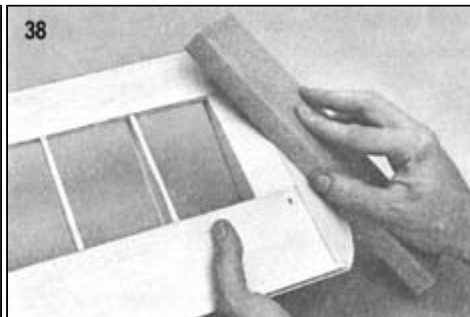

40. Sand the leading edge smooth using a long sanding block. Take your time with this step and try to keep the shape uniform along the entire leading edge.
41. Round the edge of the tip so it will not be knife sharp.
42.
  - a. Sand the top of the cap strips and planking even.
  - b. Do the same thing on the bottom.

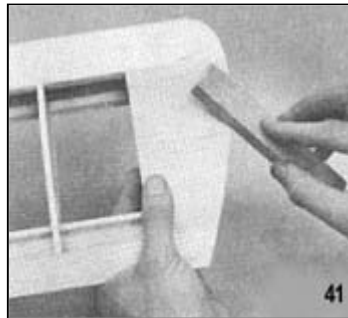
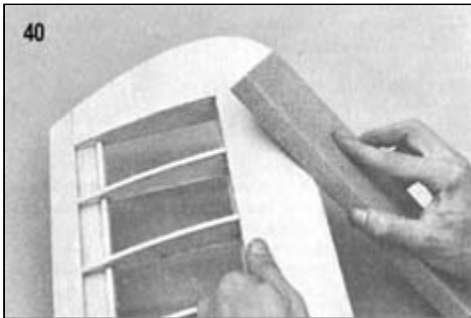

**Repeat steps 1 through 42 for the opposite wing half.**

43. Set the wing halves on a flat surface with one tip blocked up and the other half flat on the table.
44. Raise the one tip 4" at the last W-2 rib. If the joint in the center does not match perfectly, sand one or both center ribs until it does. Glue the halves together with epoxy glue. Have a "wet" joint to insure that the glue will fill any gaps in the seam. It is particularly necessary that the planking sheets, the spars and the leading and trailing edges are thoroughly glued to each other. Take up the wing as soon as the glue has set. It is easier to remove the excess that has squeezed out of the joint if it is peeled off before it cures completely.
45. Check the servo and/or servo tray you intend to use for the ailerons, and saw out an opening in the W-1 ribs to accommodate it. The plans show a 2-3/8" hole between WP and WPB, which is large enough to fit most standard servos (see the fuselage side view). If your aileron servo is exceptionally large, the opening may need to be longer.

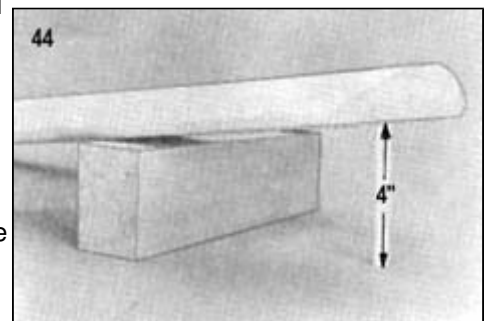
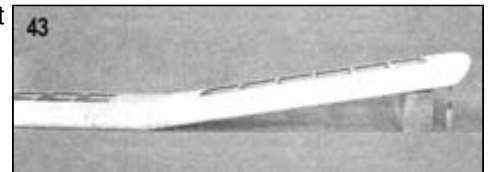

46. Cut the slots in the other W-1 ribs for WP.

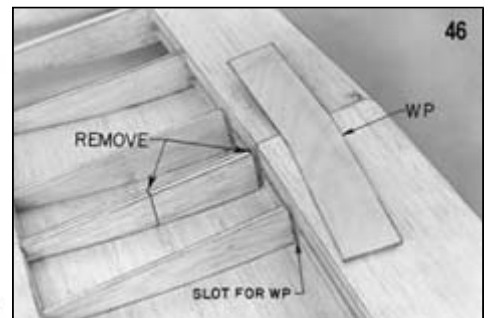
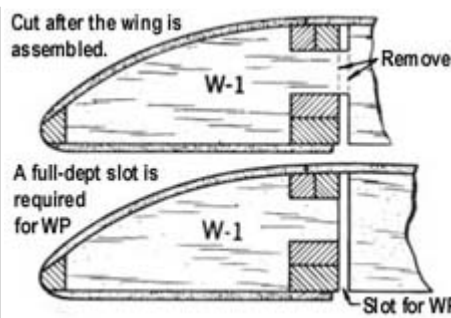
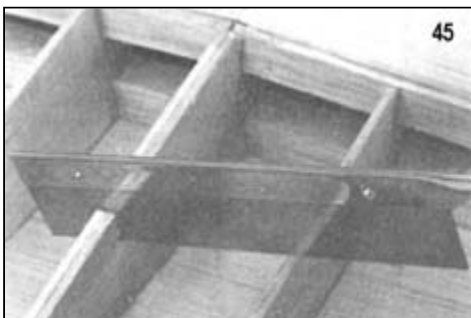

47.

- a. Epoxy glue WP to the spars, ribs & planking.
- b. Add WPB. (May need sanding to fit, depending on location.)
- c. Frame sides of servo compartment with scrap leading edge wood.
- d. Hardwood blocks for servo mount screws.

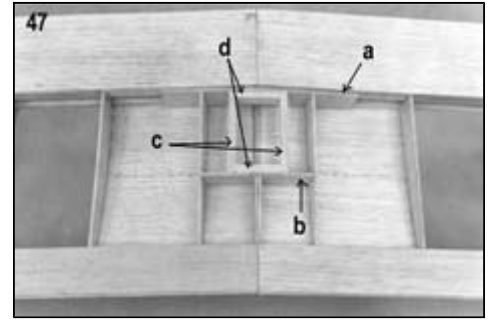

48. Cut, pin and glue pieces of 3/32" planking sheet to the bottom of the center section of the wing, leaving the servo hole open. Sand center section bottom smooth.

49. A typical R/C servo installed in the Kadet wing.

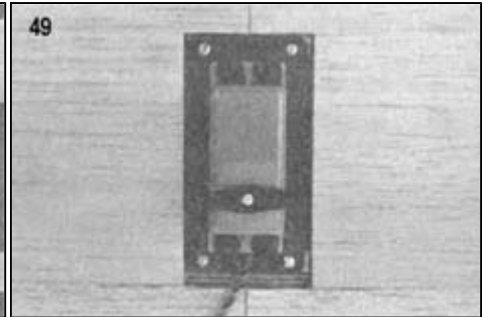
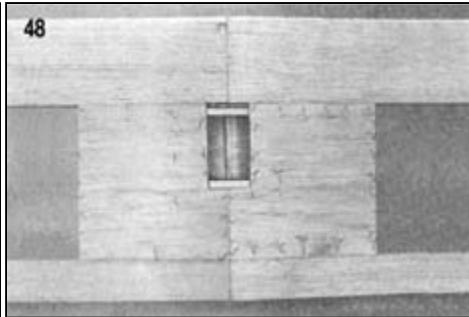
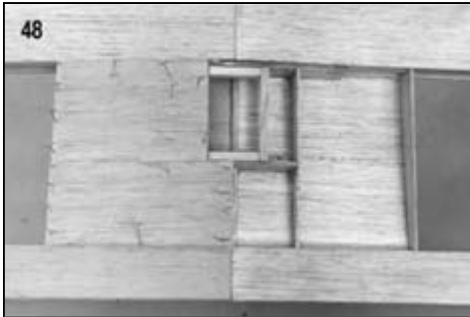

NOTE: Skip this instruction if you are going to have ailerons and go to picture 50. If you are not going to have ailerons, refer to this picture and drawing then skip pictures 50, 51, 52, 53 and 54.

### Wing Without Ailerons

If desired, the wing can be built without ailerons for use on 3 channels. If this is desired, simply glue the aileron stock to the back of the wing to form a trailing edge as shown in the accompanying drawing.



GLUE AILERON STOCK TO WING TO FORM TR. EDGE

50. Two pieces of aileron stock form the trailing edge of the center section. They must be hollowed out to fit over the aileron horn and brass tube bearing.

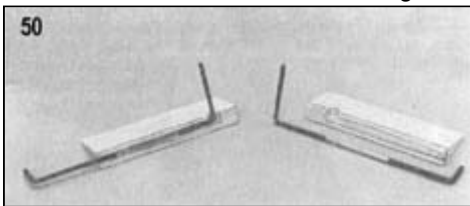

51. Glue the brass tube bearings on the back of the wing with epoxy glue.

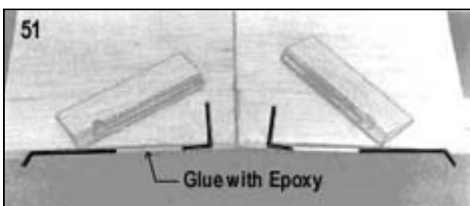

Glue with Epoxy

### Aileron Horns

The aileron horns are bent in a steel jig by hydraulic power. However, due to variations in spring tension in the wire, there may be slight variations in the horn angle. Set the pair of horns side by side, as shown in the photo. If one is not bent as far as the other, give it a twist forward, using two pair of pliers. Careful! It is easy to overbend.

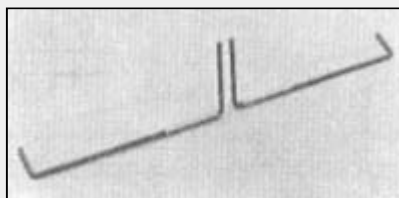

Turn self-threading nylon connectors onto the wire aileron horns. Raise or lower them to adjust the amount of aileron movement.

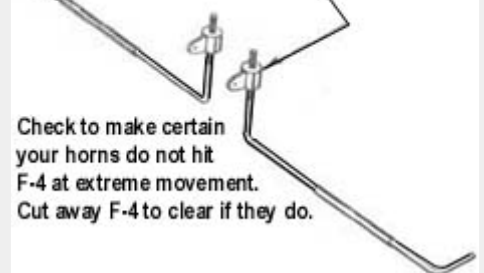

Check to make certain your horns do not hit F-4 at extreme movement. Cut away F-4 to clear if they do.

52. Epoxy the pieces of trailing edge stock over the aileron horn, taking care not to get glue on the horn itself. It is a good idea to put a film of vaseline on the horn (not the bearing - which should stick to the wood) to prevent sticking.

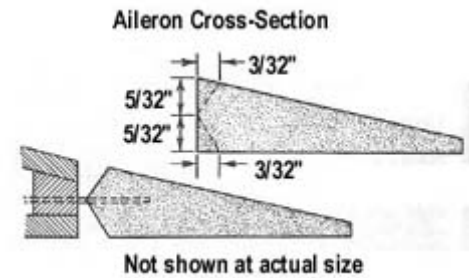
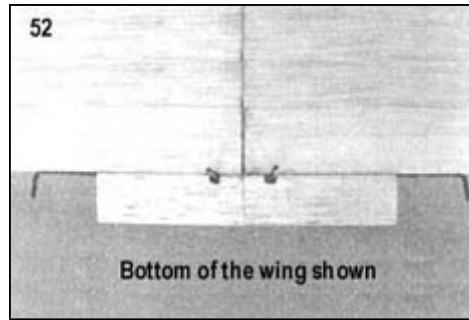

### INSTALLING EASY HINGES

Using a No.11 X-Acto blade (or similar) cut a slot approximately 1/2" in depth and slightly wider than the hinge. After all slots have been cut, insert an Easy Hinge halfway into each slot in one of the pieces to be hinged. Then carefully slide the matching model part onto the other half of the hinges. You'll find it easiest to slide the part onto the hinges at an angle, one hinge at a time.

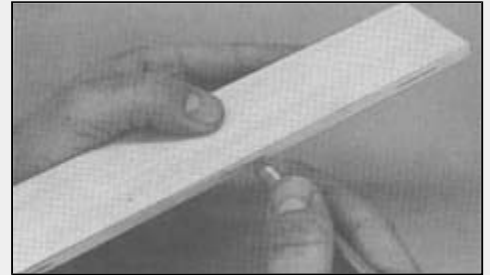

At this point the surface to be hinged is attached but not glued. Align the two surfaces and adjust the gap between them as required. For best control response, the gap should be as small as possible but big enough to allow the control surface to move to the maximum deflection that you will require.

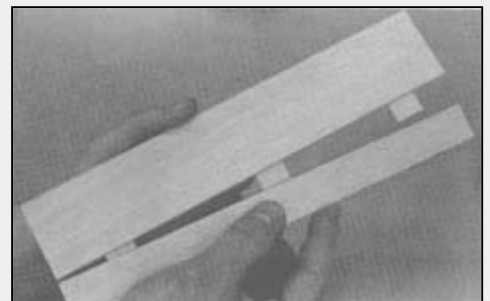

Place three or four drops of any brand of cyanoacrylate adhesive (thinnest variety) directly onto the Easy Hinge in the gap. You will notice that the glue is quickly wicked into the slot as it penetrates both the wood and the hinge. Continue this process, gluing the same side of all of the hinges. Then turn the surfaces over and repeat the gluing process on the other side of each hinge. After the glue has cured, approximately three minutes, the joint can be flexed. You may notice a slight stiffness in the joint. This can be eliminated by flexing the surface to full deflection each direction a couple of dozen times. Don't worry about shortening the life of the hinge as they are almost indestructible.

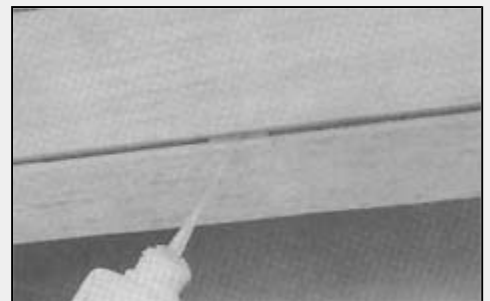

- 53.
- Draw a centerline on the front of the 5/16"x1-1/8" shaped aileron stock and shaping lines on top and bottom, as indicated on the cross-section drawing.
  - Carve and sand the front of the aileron stock to shape, so that it can move up and down without bumping the aileron. (Check before gluing in place.)
  - Slot the aileron to receive the aileron horn wire.
  - Drill a 3/32" hole in the aileron to take the arm of the aileron horn wire.

NOTE: At this point it is best to apply the fiberglass tape to the wing center joint (see below) and cover both the wing and the ailerons (see the Covering and Finishing instructions). Covering the parts separately is particularly advisable in the case of plastic film covering so that you have access to the edges of the parts with your iron.

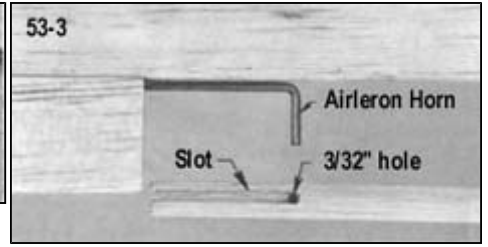
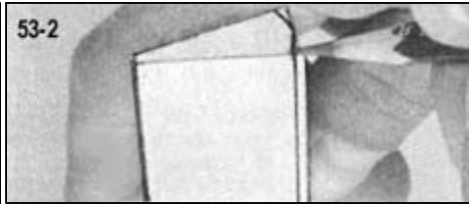

- 54.
- Cut the hinge slots in the wing and ailerons to accept the Easy Hinges. (See above for detailed information on installing the hinges.) Don't apply glue to the hinges yet! Trial fit the ailerons to be certain they are ready for permanent installation on the wing.
  - Put a 1-1/2" wide strip of wax paper about 3" long, between the wing and the aileron horn wire to keep the glue that is put into the aileron from being squeezed onto the wing during assembly. Apply 5-minute epoxy to the slot and hole in the aileron. Slide the aileron onto the horn and the hinges all at the same time. Check the positioning of the aileron before the glue sets to be certain it is located properly.
  - Just before the glue sets up, pull the ends of the strip of wax paper over the horn wire, squeezing the glue into a rounded shape and forming a skin over the wire. After the glue stiffens, any excess that is squeezed up over the aileron can be picked or trimmed off before it is fully cured.
  - Apply thin CA glue to the hinges as described in the Hinging Section.



#### APPLYING THE FIBERGLASS WING CENTER TAPE

- Cut strips of 2" tape for the top and bottom of the wing center joint.
- Coat the wing center section with epoxy glue, about 1-1/4" on each side of the joint, and lay the tape on top of the glue.
- Holding one end of the tape so it won't slip, "squeegee" the glue through the tape, with a small paddle made from a scrap of balsa. Scrape over the tape several times with the squeegee paddle to smooth the tape and remove excess glue.

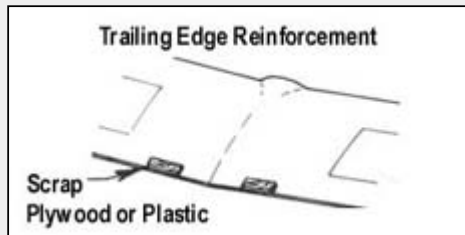
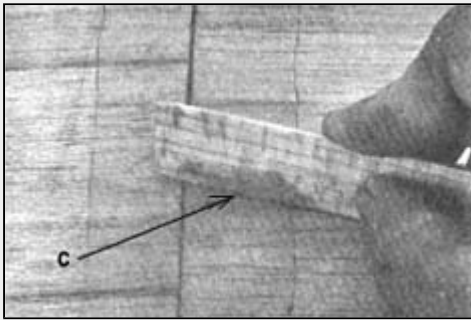

NOTE: Glue a piece of thin scrap plywood or plastic on the trailing edge at the point the wing rubber bands go over the edge to keep them from cutting into the wing. This should be done after covering.



## FUSELAGE CONSTRUCTION

Different engine brands vary considerably in the distance from their mounting lugs to the needle valve body (spraybar) in the carburetor. The ideal location for the fuel tank is to have the center line of the tank about 1/4" to 3/8" below the needle valve body. This position helps provide a reliable idle when the fuel tank is nearly empty and less change in mixture as the fuel level drops.

A 10 oz. tank is shown on the plan for those who wish to have long flight duration with large engines. We believe the Sullivan RST 8 oz. tank is the best size for the average Kadet flier and this is the size we provide in the Kadet accessory kit (available at extra cost).

Beginners find that the concentration and tension of learning to fly is tiring if a flight is prolonged much beyond 7 or 8 minutes. Some flight instructors feel that skills are developed better in shorter flights of 5 or 6 minutes. And novices often find that 5 minutes can seem twice as long. Therefore, we recommend that a 10 ounce tank be used only on .35 and .40 sized engines. Even with these engines, an 8 ounce tank will give satisfactory flying time. The typical flight with the Kadet is done with the motor partly throttled so long runs per ounce of fuel are usual. A .40 will run over 10 minutes on 8 ounces, a .35 more than 12 minutes.

Measure the distance called "X" on the accompanying drawing from the engine you will be using. For example, let's assume that distance "X" turns out to be 1". If this engine were used in a model with no downthrust, then the engine thrust line would also be the fuselage datum line. But, since the Kadet MK II has downthrust incorporated into the fuselage construction, the engine will actually be approximately 3/32" lower than 1" in the area of the needle valve, so this must be taken into account.

Subtract 3/32" from measurement "X" to produce measurement "Y" or in our example, 29/32".

To find the hole center measurement "Z" for a 10 oz. Sullivan tank cap hole in the firewall, subtract 1/4" to 3/8" from "Y".

Example:

$1" (X) - 3/32" = 29/32" (Y) - 1/4" \text{ to } 3/8" = 21/32" (Z)$ . Place the hole center for the 10 oz. tank 21/32" to 17/32" above the horizontal datum line of the firewall.

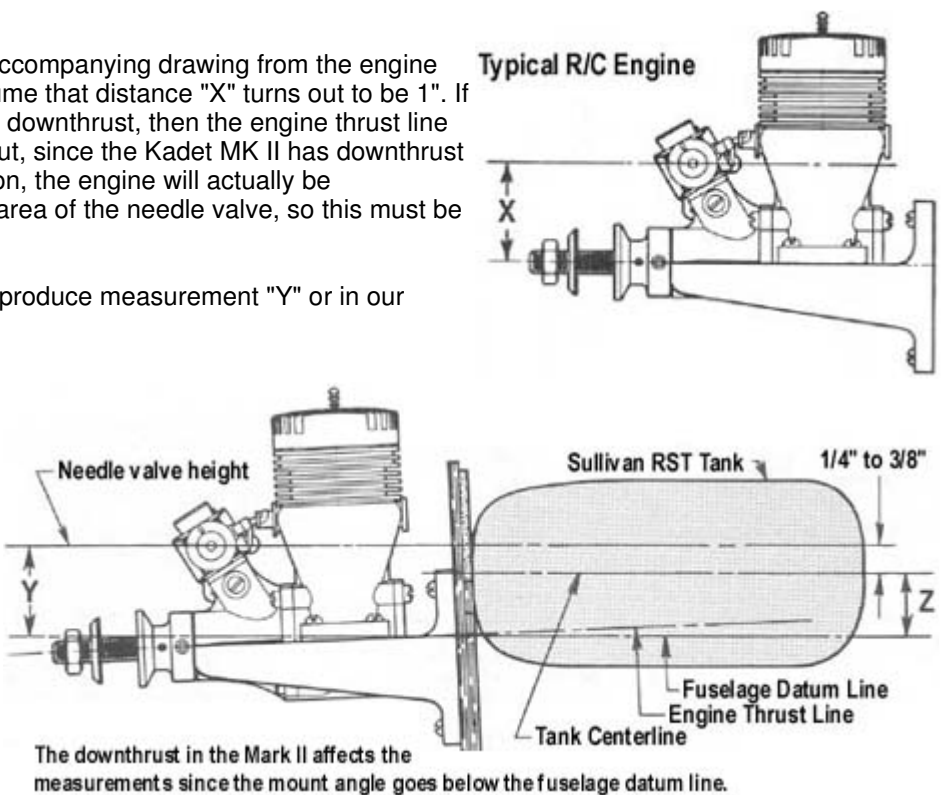

NOTE:

The builder does not have to do anything about measuring or incorporating the downthrust. Just use the printed parts furnished and it is automatically built in as you construct the fuselage.

The highest that the tank hole center can be placed for a 10 ounce RST tank without fuselage modification is 3/4" above the horizontal datum line. (The top of the tank will then be touching the center stringer of the fuselage.)

The highest that the tank hole center can be placed for an 8 ounce RST tank without fuselage modification is 7/8" above the horizontal datum line. It is unlikely that any standard engine would require it to be any higher than this, but if so it could be raised 3/16" higher by leaving out the center 3/16" stringer of the top or by cutting a notch into it.

Use Sullivan RST tanks with the wide side down. Don't use the "vent bubble" molded into the narrow side. It is not necessary for good operation of the tank. The height of the 10 oz. RST is 2-1/8" so the tank centerline is 1-1/4" below the tank top. The 8 oz. centerline is 15/16" below the tank top. When using the recommended 8 oz. Sullivan RST tank it is possible to raise it higher in the fuselage when required by a high needle valve location than can be done with a 10 oz. However, since we are working with the centerline on both sides, the dimension "Z" will be the same for either tank.

Once the datum lines and location of the tank hole have been drawn on the front of F-1A, proceed with the firewall assembly as detailed in the following paragraphs.

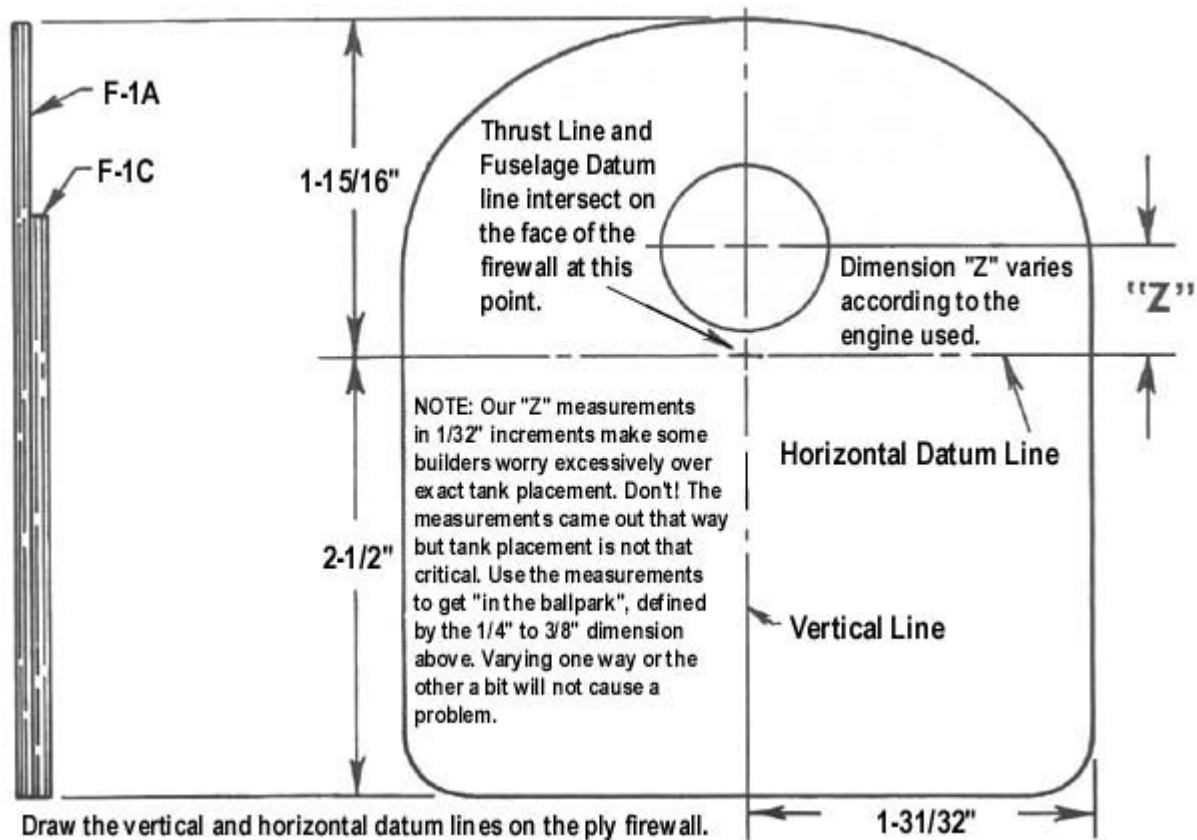

## TIPS ON TANKS

We occasionally receive suggestions from builders that a removable hatch be designed into the model for access to the gas tank. Our opinion is this is not the best method in most cases. The hatch opening makes the nose weaker and there is no good way to keep oil leaking in around the hatch. A method of fastening has to be built into the fuselage to hold a hatch in place.

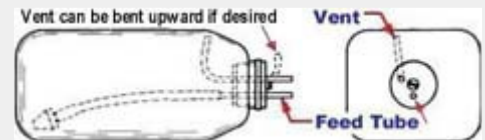

Newer Sullivan tank requires a larger 15/16" hole.



Modern plastic tanks are virtually indestructible under normal use and bursting or cracking is almost unknown. If you use Sig Heat Proof Silicone tubing (which will not harden or deteriorate in fuel) in the plastic tank, the tank will seldom have to be removed. We have models in which tank has been installed for three or four years without ever needing removal. So it is quite practical to put the tank in semi-permanently. Check the models at a contest - you'll find that the majority have sealed noses, as does this kit.

### Read this before you drill the 1" hole in the firewall.

Some fliers prefer not to bring the tank cap through the firewall as is shown in the construction sequence in these instructions. Instead they drill two holes for the vent tubes only and make the vent tubes long enough to extend through the firewall. This method requires little sealing but it is more difficult to install and remove the tank. The best way to manage this is to feed long pieces of fuel line through the holes and attach them to the tank in the cabin area. Steer the tank into the nose as the tubes are pulled back through the holes. If you are undecided as to which method you should use, our advice is that large hole installation shown in the construction pictures is the best for beginners.

Put scrap wood supports under and at the back of the tank. The front is supported by the 1/4" hole in the firewall. Seal the tank cap in the hole with G.E. Silicone Bathtub Seal (available at hardware stores) or Devcon Seal-It. Put an oil-proof finish on the firewall and in the hole before sealing the tank cap. Get some of the sealer on the sides of the hole and also put a bead over the edge of the cap at the front. Should you need to remove the tank, break out the scrap wood supports in the rear and push out the silicon rubber seal around the front cap. Reach into the fuselage and guide the tank outside.

Some builders, after putting their receiver battery in a plastic sack, taping it shut, wrapping it in a foam rubber package and stuffing it into the nose under the tank, then stuff paper toweling or foam rubber in to fill the nose compartment and keep everything firmly in place.



After installation, put fuel tubing on the vent tube and run it to the outside of the cowling on the bottom, so that fuel overflow is not blown over the wing-fuselage joint, where it may leak into the fuselage. The best way to fill the tank is to take off the fuel line to the needle valve and pump the fuel in there until it runs out the vent. Be sure and use a filter on your fuel supply can, and it is a good idea to have a filter between the tank and the needle valve also.

### Pressure Feed



If the engine you are using is equipped with a muffler pressure tap, make use of it for a more even fuel feed and reliable operation. The hookup for pressure feed is shown in the picture. To fill the tank, remove the fuel line from the engine and pump the fuel in. When the tank is full, it will overflow through the muffler pressure line. Use transparent or translucent fuel line so you can see the fuel starting to overflow when the tank is full. Should some fuel happen to get in the muffler, drain it out before starting the engine. Do not try to fill the tank in reverse from the pressure line, the tank will not fill properly and fuel may be forced into the engine.

## Firewall Assembly

55.
  - a. Smooth and even F-1A and F-1C with the sandpaper block.
  - b. Glue them together with epoxy glue as shown in the accompany drawing to make the firewall. If they should be warped, clamp them together with "c" clamps or put the assembly in a vise while the glue is setting
  - c. Mark the vertical and horizontal datum line.

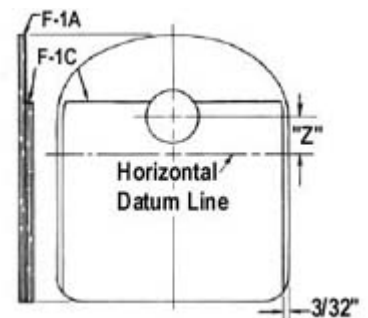

56. Place the motor you will use on the firewall and draw lines as a guide for positioning the glass-filled motor mounts. (Different motors have different mounting dimensions.)

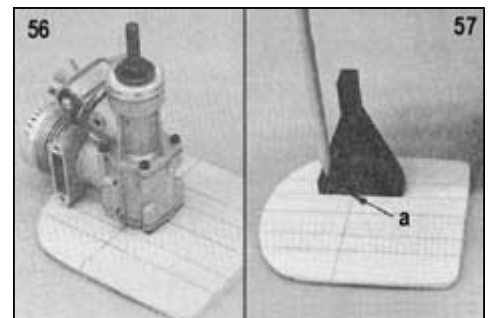

57.
  - a. Line up the marks on the side of the mount with the horizontal line you have drawn on the firewall as shown in photo 57.

NOTE: Read "Tips On Tanks" before cutting out a tank hole.

58.
  - a. Locate the center of the tank cap hole and draw a 1" circle on the wood.
  - b. Drill a series of holes on the inside of the circle.

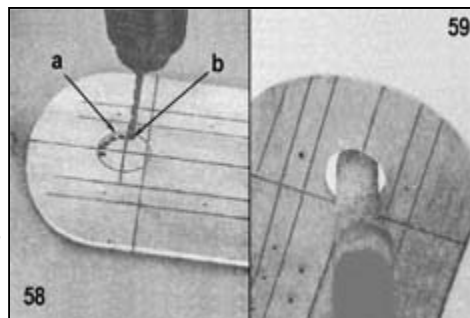

59. Break out the wood and sand the edges smooth with sandpaper wrapped around a dowel.

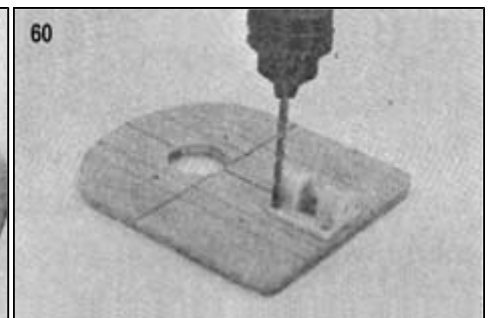

60.
  - a. Drill out the motor holes on the firewall with a 11/64" drill bit for the 6-32 blind nuts.
  - b. Position the nylon nose gear bearing on the firewall, punch the holes with an ice pick or awl and drill out with a 7/64" bit to pass the 4-40 bolts.
  - c. Turn the firewall over and drill out the backs of the 7/64" nosegear bearing holes with a bit to take the shanks of the 4-40 blind nuts. To complete the holes, take a modeling knife and round off the edges on the back of the firewall so that the rounded off part of the blind nut will fit down into the hole when it is pulled tight against the firewall.
  - d. Drill out the backs of the motor mount holes with a bit to take the shanks of the 6-32 blind nuts.

61. Be sure and epoxy the blind nuts to the back of the firewall so they will not come out later when it may be necessary to take off the mounts. Don't get epoxy into the threads of the bolts. Pull the blind nut points tight into the wood with the bolts before the glue sets up.

With the mounts and nose gear bracket in place, cut off the mounting bolts for both flush with the face of the blind nuts on the back of the firewall. This is to prevent any chance of the bolt ends puncturing the tank or rubbing on the batteries.

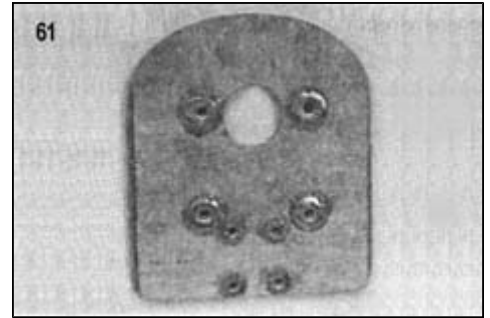

62. a. Put the spinner backplate that will be used on the motor. (Note: Some backplates have a recess in the back as does this Goldberg spinner used on the prototype Kadet Mark II. This is why the measurement must be taken from the spinner backplate itself and not the prop drive washer on the motor.)
- b. Position the motor on the mounts so the spinner backplate will be 3 1/2" from the face of the firewall. It is handy to tack the motor in position with some spots of epoxy, brought up over the edge of engine to grip it good or put a strip of double-faced masking tape between the engine and the mounts. This will keep it from slipping during the next step.

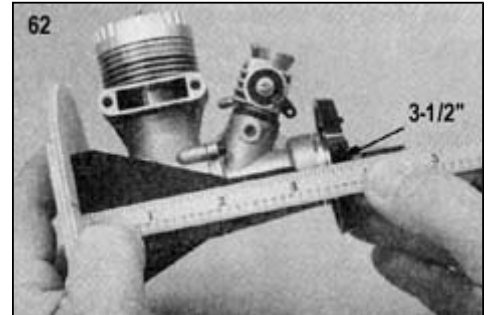

63. NOTE: Read "Cowling Installation" at step 124

Mark the engine mounting holes as shown in photo #63. Remove the engine, and mounts from the firewall, and drill at the marks with a bit that's just large enough to clear your engine mounting bolts. (Hint: if you are not used to doing this sort of job, don't try to punch and drill all 4 holes at once. Punch and drill only one hole. Then put the motor back on the mounts, secured by the first bolt. Punch and drill a 2nd hole, repeat the procedure, then a third hole, etc. With this process you are much less likely to make a drilling mistake that will ruin the mounts.) Drilling our mounts will not be a problem if a good quality high-speed drill bit is used, operated at neither too fast or too slow a speed and with moderate pressure.



Re-install the motor mounts to the firewall, then bolt the engine in place. SIGSH109 6-32x3/4" socket head bolts for long engines and SIGSH652 Aircraft Lock Nuts, or SIGSH104 4-40 x 3/4" and SIGSH651 Aircraft Lock Nuts for small engines are recommended for mounting. They are not furnished in this kit. It helps with this method to file a flat place on the bottom of the mount, so the locknut will set flush with the bottom of the mount.

NOTE: If the fuselage sides are bowed or warped, it will not be a problem. Pinning them down to a flat building board and gluing on the structure will flatten them out.

64. a. Drill or cut out the dowel holes in the fuselage sides so they will be located after the inner doubler is installed.
- b. Trim off the fuselage sheet even with the back end of the fuselage and glue the rear fuselage extension in place. Use a straight edge to make certain it is lined up straight with the rest of the fuselage side.

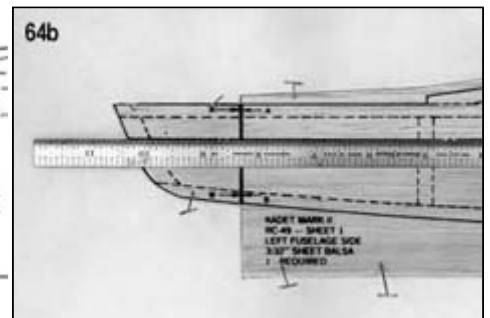
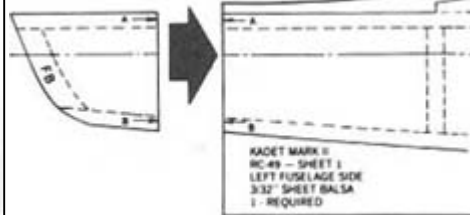
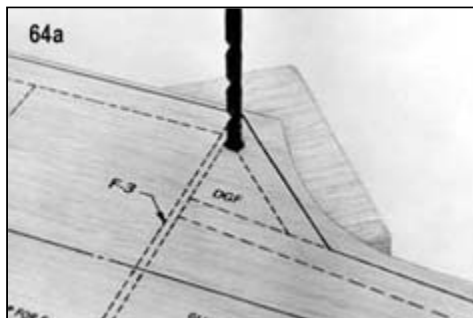

65. Glue on the 1/4" sq. balsa pieces around the edges of the fuselage sides as indicated on the printed sheets. Also cut and glue the 1/4"x1/2" balsa strip located under the wing.

66. a. Pin and glue pieces of 1/8" x 3/8" balsa in place.  
 b. Note the gap left for F-3.  
 c. Glue die cut Lite-Ply nose doubler FN on the nose.

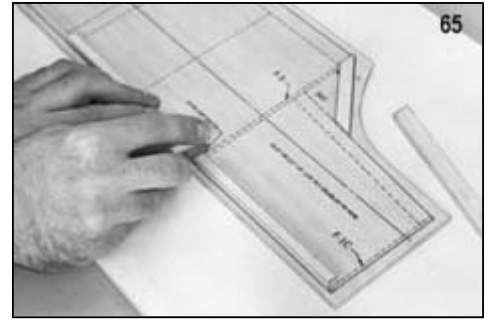

CAUTION: Epoxy is recommended for FN. Water base glues such as Sig Bond, Tite Bond, Elmer's etc. may cause curling because of the large area being glued. Spread a thin film of epoxy with a paddle. Don't use a large amount of glue - it will add weight to the model.

67. a. The balsa cabin doublers are cut from 1/8" x 3" sheet. (Note: Because sheet wood varies in actual width, the dotted lines printed on the fuselage side may not line up exactly with the sheets. It makes no difference - just install the sheets butted against each other.)  
 b. A gap is left for cabin former F-3.

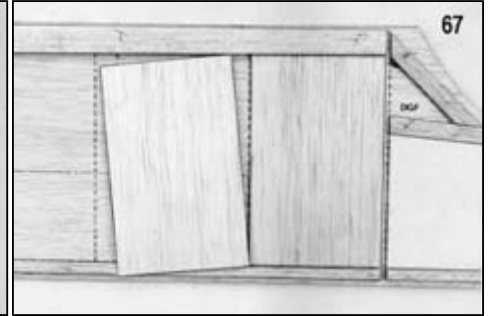
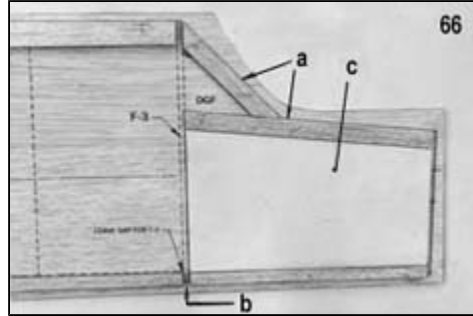

68. a. Glue the 1/4"x1/2" balsa strip at the end of the second 1/8" doubler sheet piece.

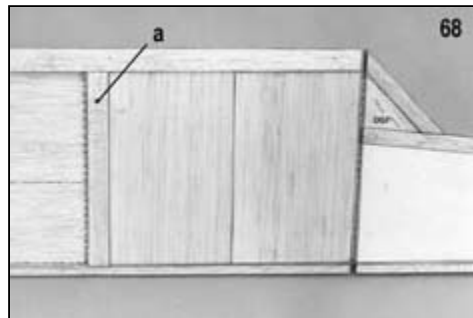

69. a. Continue on back, adding pieces as indicated.  
 b. Leave a gap for F-4.

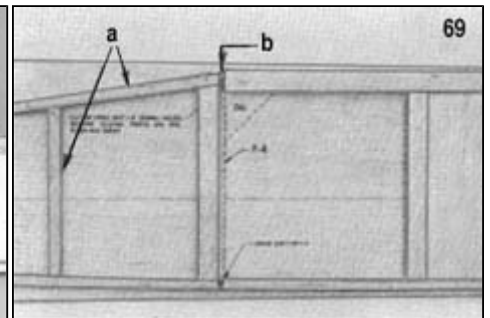

70. a. Cut the 1/4" sq. balsa side stiffeners a little overlength and finish to an exact fit using a sanding block. Always try for good joints without gaps - they are stronger than trusting the glue to fill the gap. If you have a perfect fit, you can use thin CA to glue the parts; otherwise, use medium CA. Slow CA or epoxy will fill gaps in an emergency, but remember those joints will be heavier than joints made with thin CA or Sig-Bond.  
 b. Cut FB out of the printed tail parts sheet.

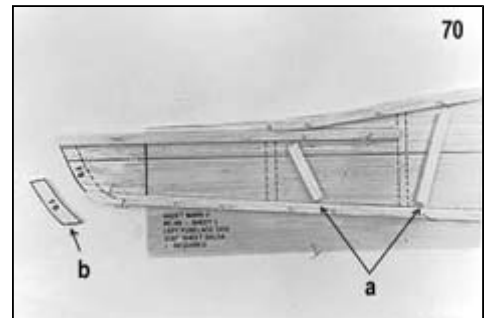

71. Glue the parts in place.

72. Cut the fuselage sides from the sheet with a modeling knife. Don't cut too close, leave a bit for sanding, cutting too close can result in too deep a cut that is harder to fix than taking down the side a little with the sanding block.

73. Finish the side to exact contour by use of the sanding block. Place the two sides together and match them by sanding as required to make them duplicates.

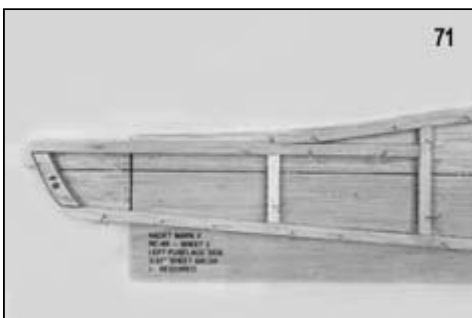

74. Add DCF and DC.

75. Put 5 minute epoxy on F3 and glue in place on one of the sides. As the glue sets up, use a triangle to get F3 exactly perpendicular. Other glue can be used if you secure the former in place while it is drying.

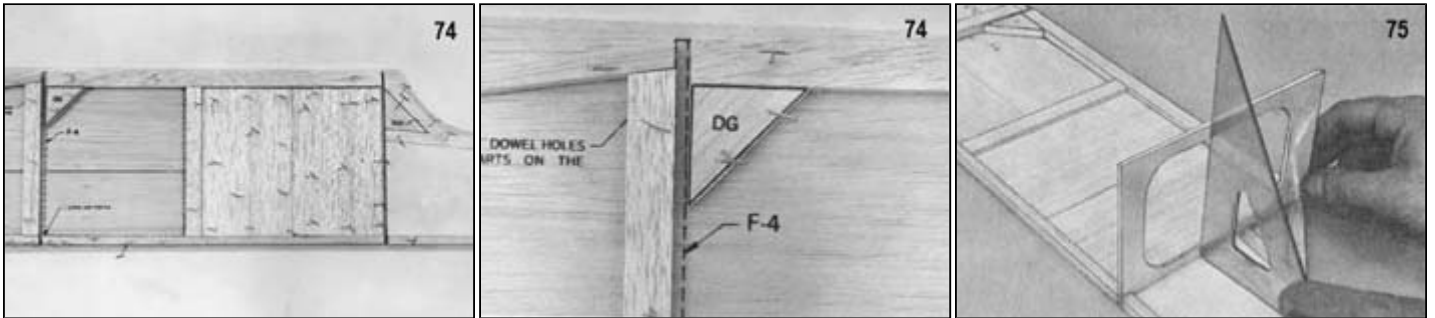

76. Repeat the procedure with F-4.

77. Pin the fuselage side to the top view plan along the flat part between the nose and the landing gear plate position.

78. Epoxy glue the remaining side to F3 and F4. Pin in place and check for square with a triangle.

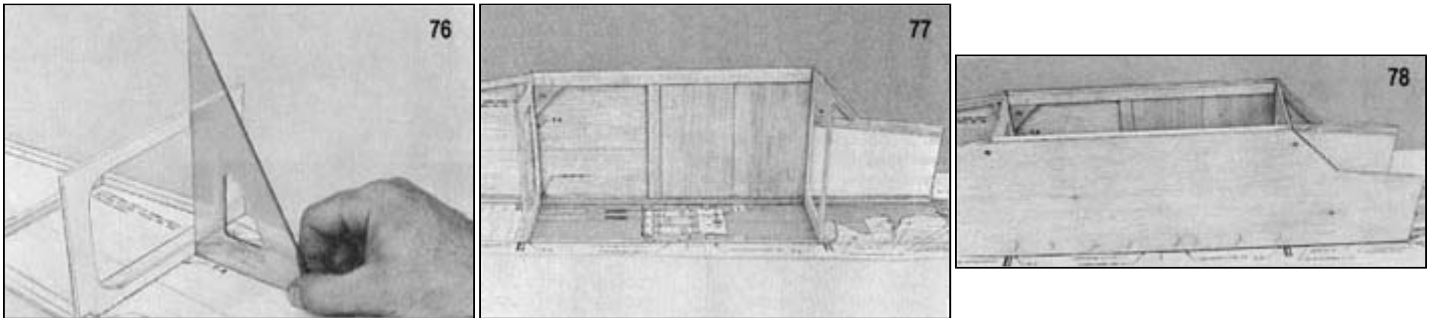

79. The bottom at the rear is joined with a piece of scrap 3/32" sheet. (It is shown here after being glued in and dry. Don't take up the fuselage from the plan to put this piece in, but fit it in from above before the top crosspiece is put in.)

80. a. Pull the rear end together by using square weights or something similar (pieces of scrap iron shown here) that is perpendicular and yet heavy enough not to move.
- b. Pin and glue the rear cross pieces in place.

81. Glue in the four remaining 1/4" sq. balsa rear fuselage cross pieces.

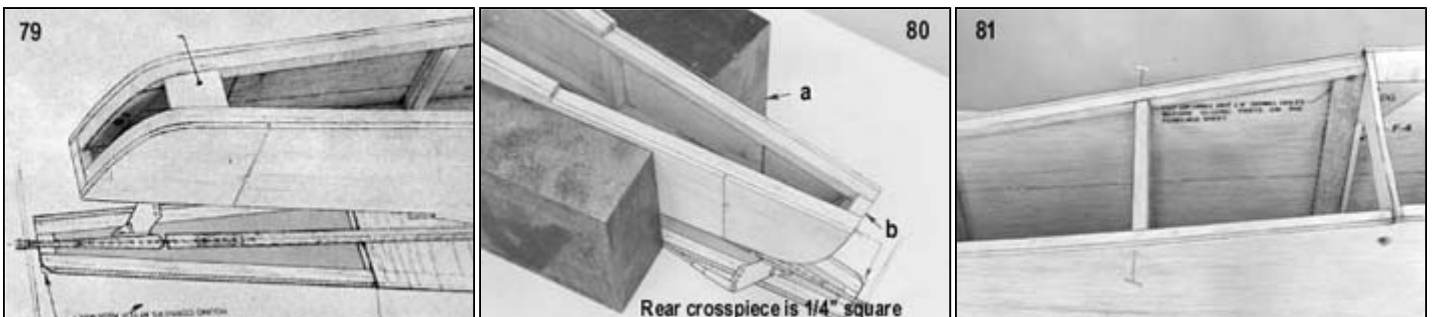

82. Use pins and masking tape to hold the rear fuselage together until the glue dries.

83. a. Drill through the 1/4"x1/2" balsa strip.
- b. Trial fit the 1/4" dia.x5-1/4" rear hold-down dowel, but don't glue it in place until after covering.

84. Glue the 1/4"x1/2" balsa crossbrace to the back of F-4, but not to the dowel until after covering.

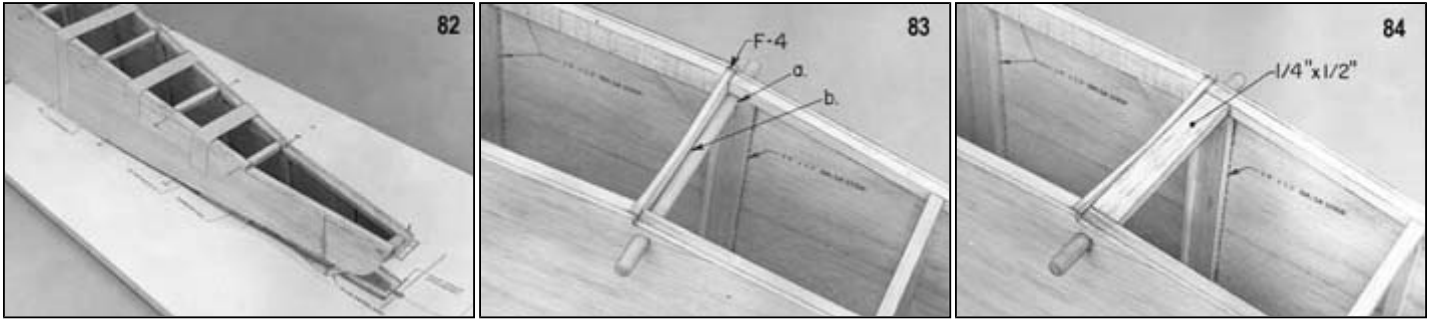

85. Add the 3/32" sheet balsa fill-in at the back part of the fuselage, just in front of the stabilizer mount. This fill in is only on the top of the fuselage and serves as an anchor block for the tab on the bottom of the fin.  
NOTE: This fill-in is inset between the 1/4 square and is flush with their top. The grain runs lengthwise.

86. Epoxy the firewall assembly F-1A and F-1C to the front of the fuselage. Note that the top of F-1C is even with the top of the fuselage sides, and the bottom of the firewall extends about 3/32" below the fuselage sides.

- 87.
- Cut pieces of 3/4" triangular stock to fit against the rear of the firewall as braces.
  - The stock may need to be notched out a bit to fit over the blind nuts.



- 88.
- Pin balsa triangles FT temporarily in place.
  - Glue F-2 in place on the fuselage, using printed wood triangles FF, glued to the fuselage and F-2, to hold it against FT.
  - Remove sawn balsa triangles FT after the glue is dry.
  - Glue on F-1B.

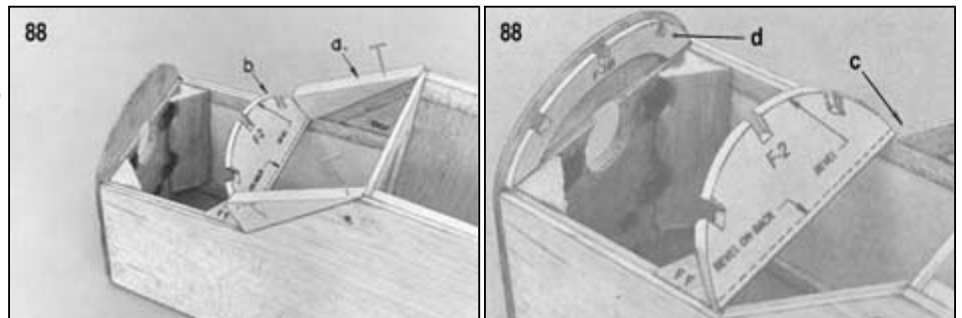

- 89.
- Glue 3/16" sq. stringers into notches in F-1B and F-2.
  - Cut off flush with the face of F-2.

STOP: Go back and reread "Tips On Tanks".

- 90.
- Carefully cut away the bottom of F-2 so that the fuel tank will fit into place. (Note: With the higher tank locations, do not cut into F-2 as far as will eventually be necessary because too large a cutout at this stage of construction will weaken F-2 to the point that it might crack when pressure is applied during the sheeting process. A partial cutout will be sufficient to perform Step 91.
- 91.
- Glue scrap blocks on each side of the tank to hold it in position. Don't get the blocks too tight, just enough to keep the tank from rattling around. The tank will need to be removable after the fuselage top is on by pulling on it from the bottom side. Hold the tank in place with temporary scrap crosspieces across the bottom and the back. They can be broken out when necessary to take out the tank. Or, you can stuff paper or foam rubber and the battery under it.

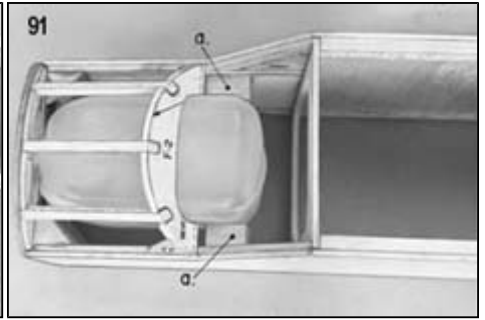
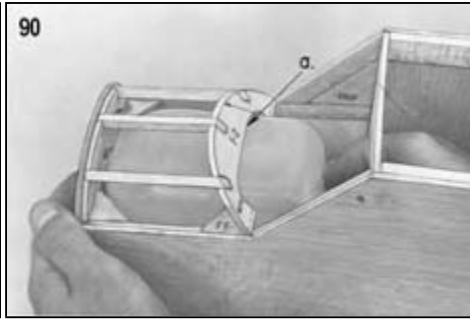
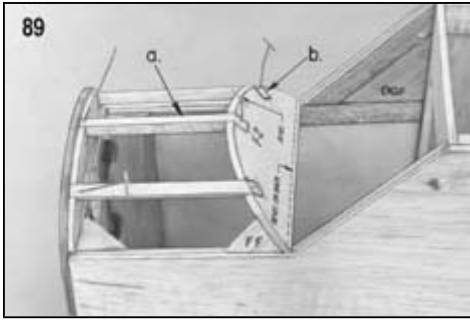

92. a. Cut a piece of 3/32" balsa sheet large enough to cover half of the nose. Bevel the bottom edge so that the sheet is started over the curve.  
 b. Pin and glue the bottom edge to the fuselage side.
93. a. Dampen the sheet with water until it is pliable. Curve it over the stringers and glue and pin in place. After it is dry, trim the upper edge on the center of the top 3/16" sq. stringer.
94. Repeat the process on the other half of the nose.



**Note**  
 The nose planking goes in easier if it is started at the angle shown.

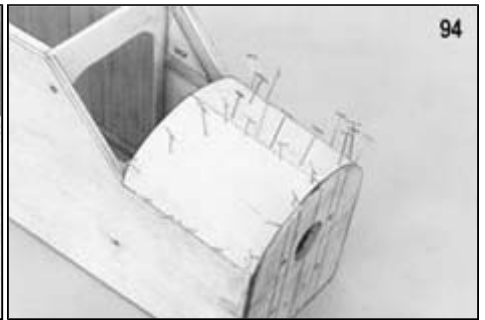
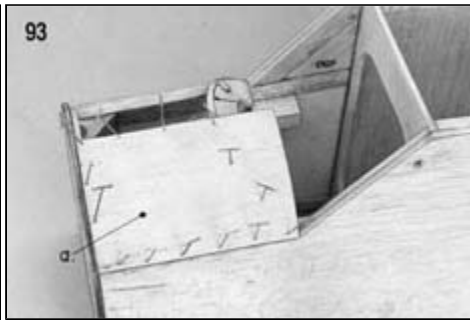
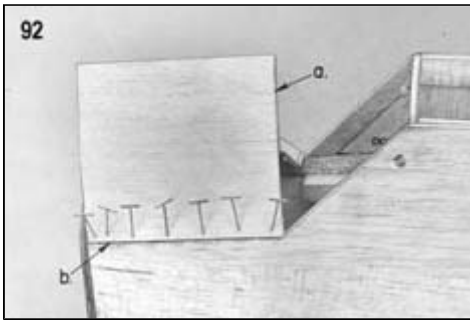

95. Trim the edge of the sheet flush with the face of F-2. Now complete the tank clearance cutaway in the bottom F-2 (Pictures 90, 91) to whatever amount is necessary to allow the back of the tank to be raised to the desired height.

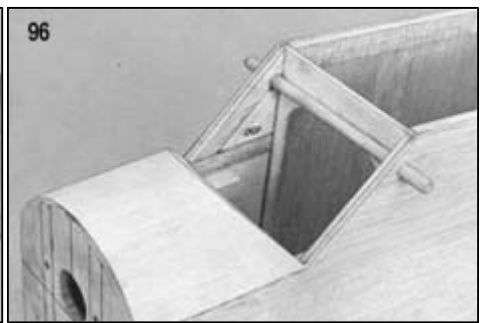
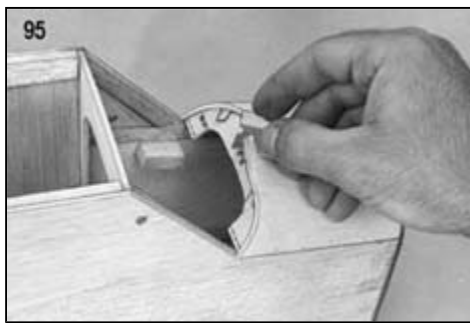

96. Drill the dowel hole and trial fit the front 1/4" dia.x5-1/4" wing hold-down dowel. Glue the dowel in place after covering.

97. Glue the 1/4"x1/2" balsa crossbrace to the front of F-3, but not to the dowel.

98. Trim the 1/4"x1/2" piece to the same angle as the fuselage sides.

99. Glue the triangles FT to the fuselage and to F-2.

STOP! At this point decide which type of windshield you will use, regular or simplified and follow whichever directions apply.

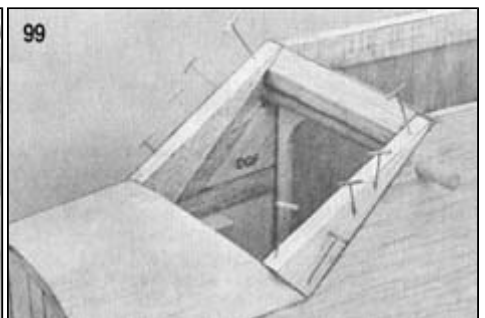
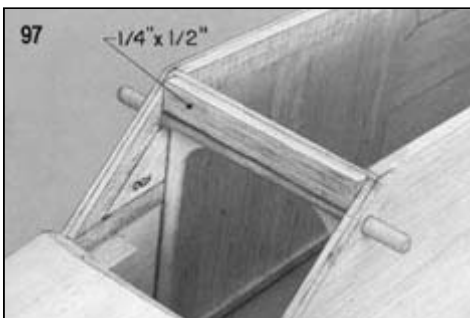

## Regular Windshield

100. Carefully cut the ends of the 3/4"x4"x3 1/4" windshield block to fit on the fuselage, using the side pattern WS. Trace the pattern on both sides of the block and don't cut too close to the lines. Finish with the large sanding block, fitting to the fuselage as you work the block to final shape.

With some of the higher tank positions, it is necessary to cut away the bottom of the windshield block so it will clear the top of the tank. To keep from cutting too deep into the block, trace the outline of F-2 on the bottom of the block as a limit guide to the tank cutout.

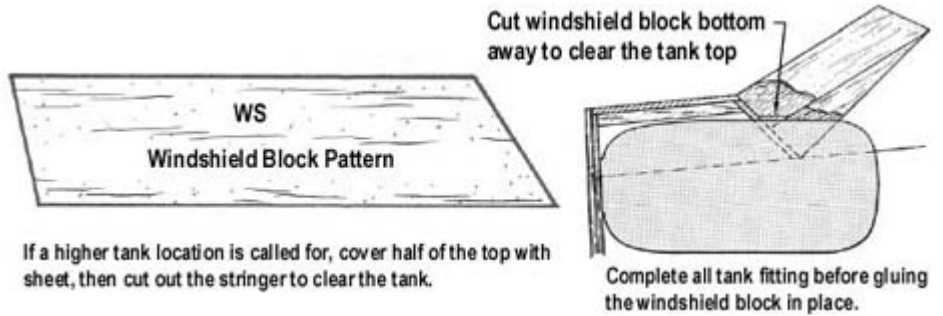

Incidentally, if you want to save a little weight, do not glue on the windshield block in as shown in picture 100-2, but leave it pinned in place until after the rough shaping done in Picture 103. Remove the block and carve out the interior of the block with a wood gouge. A shell of 3/16" thickness is more than enough strength.

101. a. Hold the wing in place on the fuselage.  
b. Cut into WF as required to make it fit against the wing and bevel it on the back to sit down on the top of F-3.

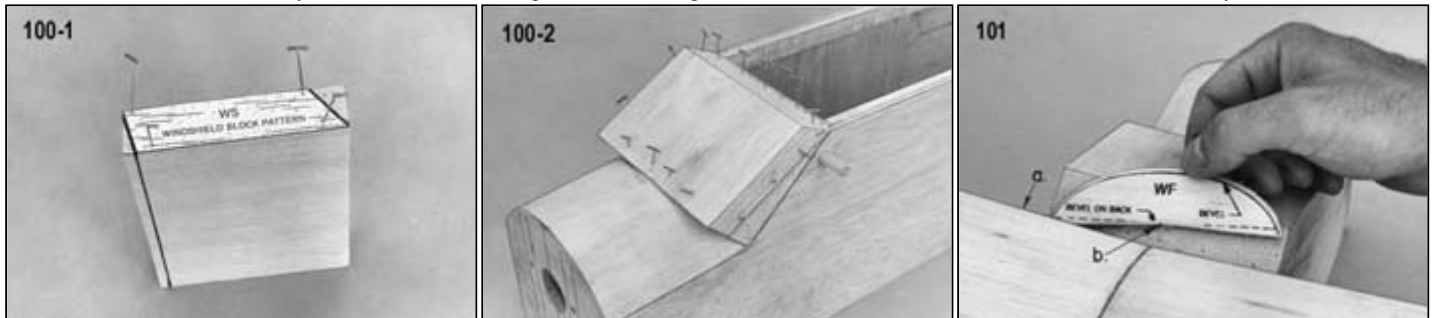

102. Trace the outline of WF on the top of the windshield block.

To save weight, hollow out the windshield block after it has been roughed to shape.

103. a. Remove the wing and WF.  
b. Carve the windshield to rough shape.
104. a. Return WF to its place, but this time with a piece of wax paper or plastic wrap between the fuselage and the wing.  
b. Glue WF to the leading edge of the wing.

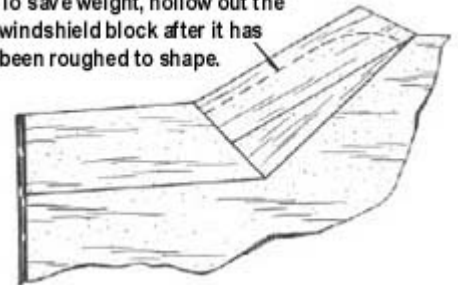

105. Glue FP in place on the center of the wing and to WF

106. Cut a fairing block to fit on the wing - WF juncture using the FP pattern on the plan.

107. Round the block to a pleasing shape that blends into the wing contours, and glue it in place. Finish shaping with a sanding block.

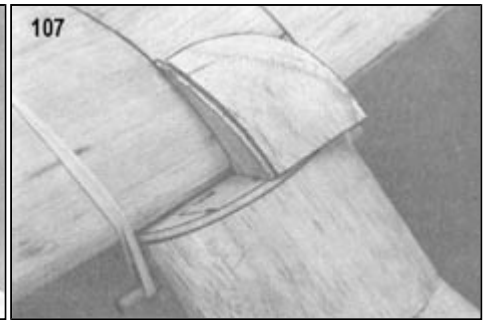
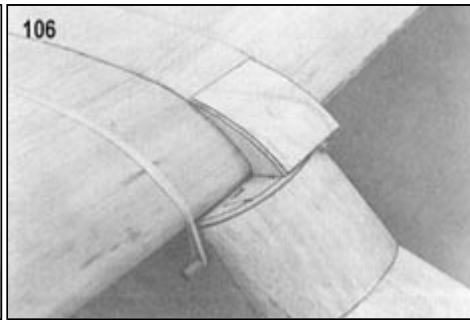
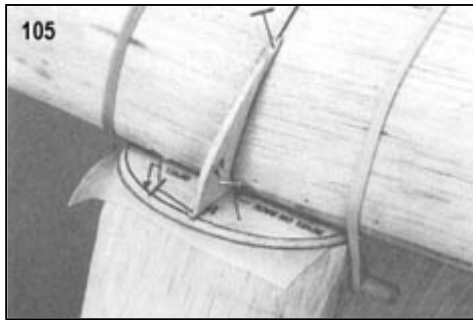

## Simplified Windshield

If you have selected the optional windshield which requires no fairing on the wing, follow these directions, instead of 100 through 107 above.



100S Use pattern OW instead of W8 to shape the windshield block. Trace it on both sides of the block.

101S Carve or saw the block to size.



102S Glue the block in place and carve it to shape.

103S. a Put a piece of wax paper on the fuselage.  
b Make a small fairing on the front of the wing with a piece of 3/16" sq. or other scrap and glue it to the wing. Shape it to fill the gap between the wing and fuselage. Any small gaps can be filled with Sig Epoxolite Putty or epoxy glue. Now go on to picture No. 108.

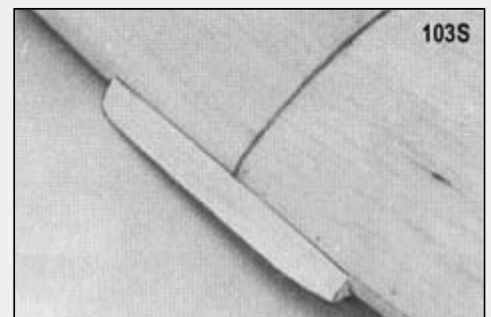
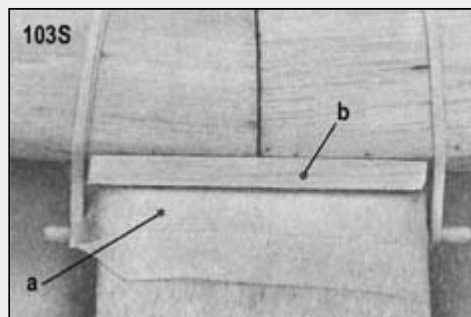

This is the best time to install the pushrods, while easy access is possible through the bottom of the fuselage. We recommend SIGSH559 nylon tubing - wire cable push rods for the nose gear and throttle.

108.
  - a. Bolt the nose gear in place with the cable attachment fitting on the steering arm.
  - b. Mark the best spot on the firewall for the pushrod to exit and hit the fitting. (The steering arm must be angled forward so when the servo pulls it back for a turn, it will clear the firewall. So remember that the arm moves farther out than it does in and pick the center of the movement for gauging the exit hole.)
109. With a long drill or a piece of music wire (put a point on it and a notch) drill out the firewall on the mark.
110. Drill on through the fuselage with the drill or wire at the approximate angle to carry the pushrod cable to the servo. (Look ahead a little in the instructions if you are uncertain and place your servos in the fuselage at the approximate place they will be so you will have a better idea of what you are shooting at.) Placement is not very critical - the approximate location is shown on the plan. Be sure and leave enough space ahead of them to get the tank in and out.



111. Put the nosewheel pushrod tubing in place and use the cable to locate it in relation to the steering arm. Do not glue the pushrod tubing to the firewall yet.

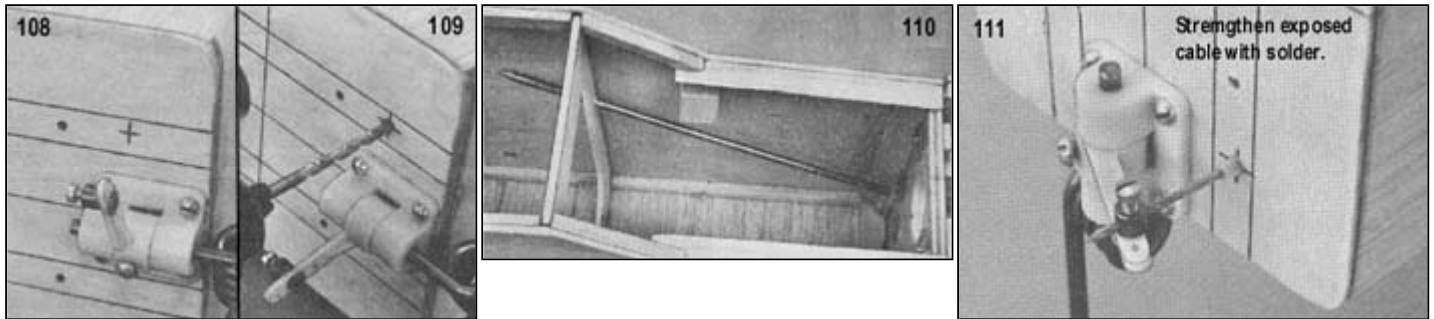

## RADIO INSTALLATION

This photo below shows a typical radio installation in a Kadet MK II. The radio that you decide to use in your model may have a slightly different appearance, but the photo should give you a fundamental idea on how the components will be arranged in the aircraft. For more specific information on radio installation, refer to the booklet "Basics of Radio Control."

There are several important items in the photo that should be emphasized. First, notice the amount of padding wrapped around the receiver to protect it from vibration. The battery is equally well protected and is located under the fuel tank (not visible in the photo). Notice also how the radio antenna exits the fuselage side as close as possible to the receiver. The on/off switch is mounted internally on the servo tray. A nylon rod is used to activate the switch from outside the model. Lastly, notice how all of the wiring has been neatly tucked away where it can't interfere with the moving servo arms.

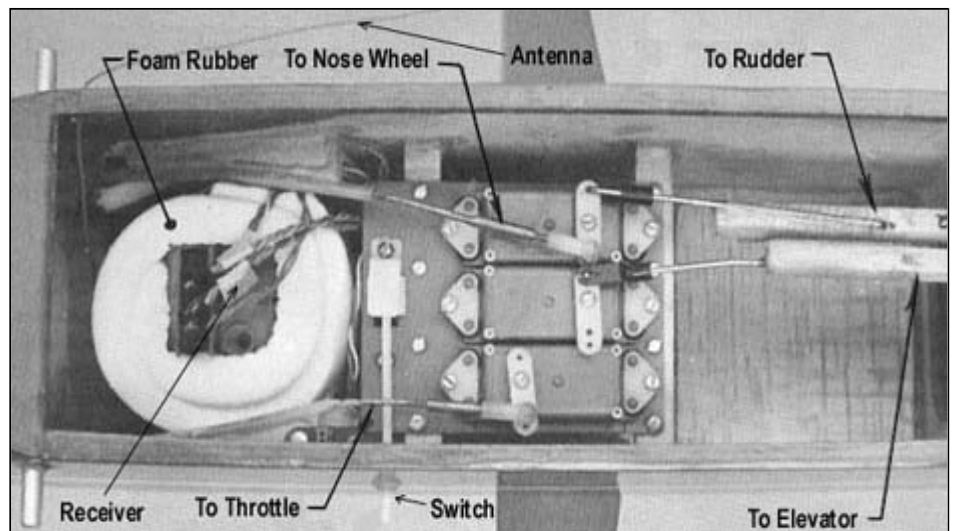

The servo tray shown mounts three servos side-by-side. This arrangement works well in the Kadet MK II because of the generous width. However, not all radios come with a servo tray in this configuration. Most radio sets now come with a 2"x1" type servo tray which has two servo openings side-by-side and one opening turned 90 degrees so the servo sits crosswise in the fuselage.

This type of tray is perfectly suitable to the Kadet. We recommend that you use the two side-by-side openings for the elevator and rudder servo, and the remaining opening for the throttle servo. Align the tray so that the throttle servo is towards the front of the fuselage.

Materials to construct the rudder and elevator pushrods, including the 1/4" sq. balsa pushrod sticks, are included with the kit. Flexible cable pushrods (Sig SH-559) are required for the throttle and steerable nosewheel, but must be purchased separately. Study the plans and "Basics of Radio Control" on how to make pushrods.

This photo shows another model but the aileron hookup in the Kadet Mk II is done in the same way.

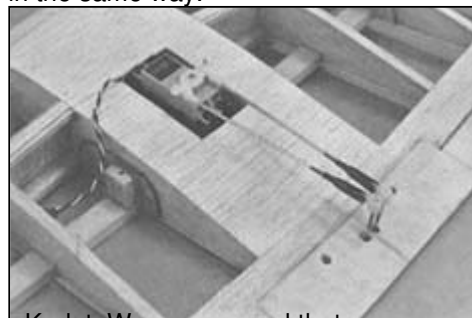

### KADET MARK II ACCESSORY KIT

All of the extra parts needed to finish your Kadet in one convenient package at a lower price than buying them separately. ORDER SIGAK249.

- 2 2-56 RIC Links
- 1 2-1/2" Nose Wheel
- 2 2-3/4" Main Wheels
- 1 8 oz. Fuel Tank
- 2 Solder Clevises
- 2 Threaded Couplers
- 1 2" Dia. Spinner
- 1 5/32" Wheel Collar & Allen Wrench
- 24 #64 Rubber Bands
- 4 4-40 Engine Mounting Bolts
- 4 4-40 Hex Nuts
- 4 #4 Flat Washers
- 1 12" Heat-Proof Fuel Line
- 2 Flexible Cable Pushrods

112. Run the tubing in flowing curves from the nose to the servo location. Picture 112A and 112B show a typical tubing installation in another model, but the Kadet Mark II is similar.

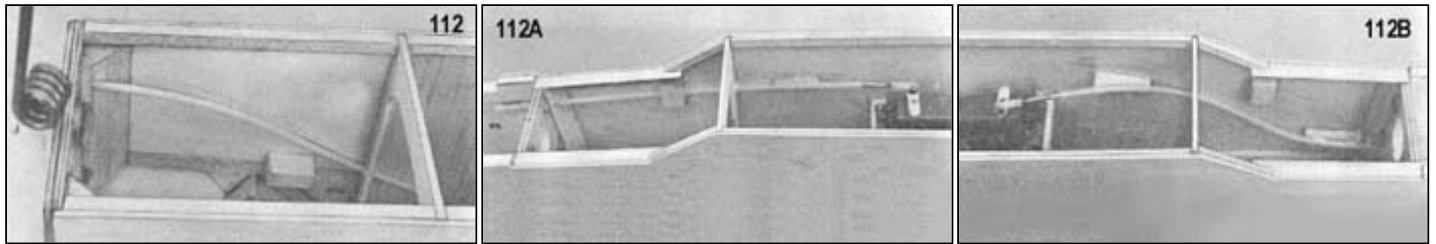

113. a. Scrap block standoffs can be used to hold the pushrod tubing in position.  
b. After the tubing is located, the cables can be completed and installed.

NOTE: Roughen the nylon tube with sandpaper before you epoxy it to the standoff.

114. Fit and glue the piece of 1/4"x3"x3-1/4" balsa (LGB) in between the sides on the fuselage bottom.

115. Glue the 1/8"x4"x12" piece of Lite-Ply to the bottom of the fuselage at the nose. Use tape to hold it until dry.

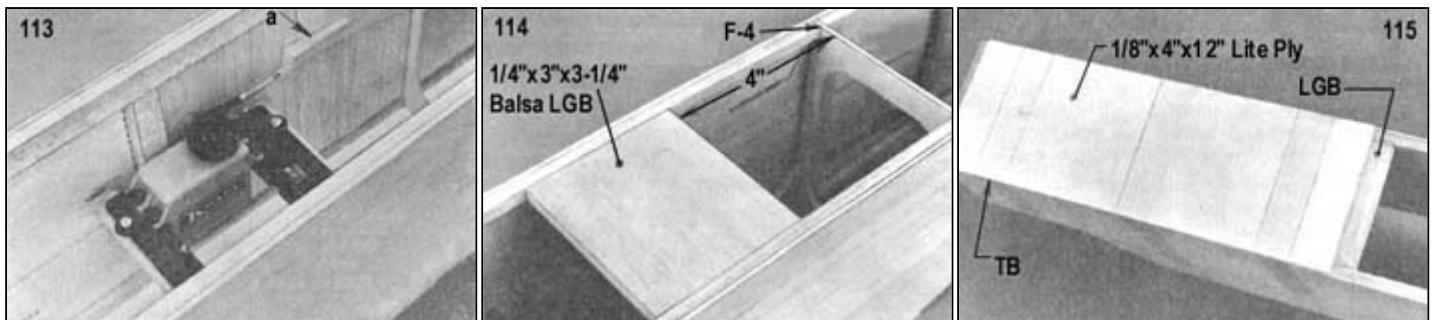

116. Glue pieces of 3/32" x 3" balsa sheet to the bottom of the fuselage behind the Lite-Ply.

117. The top of the fuselage, from F-4 back to the stabilizer opening, is covered in the same manner as the bottom.

118. Glue LGP to the inside of the fuselage on LGB.

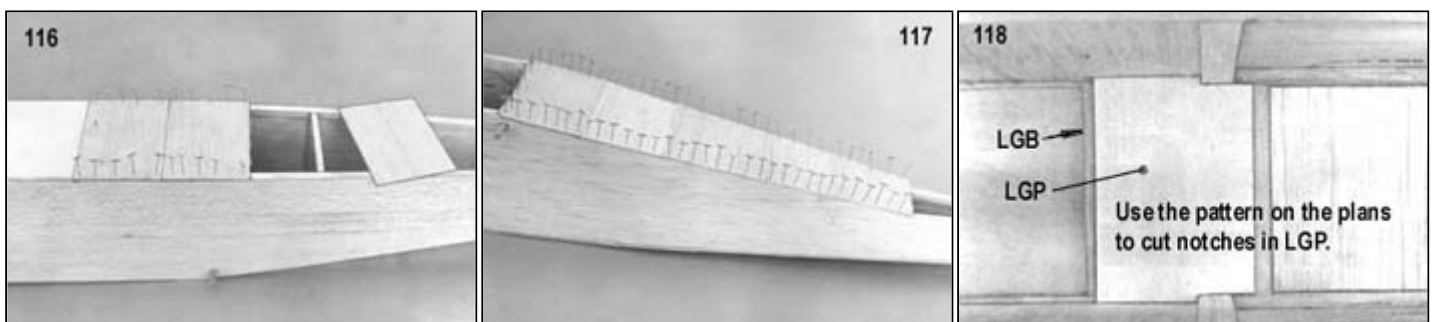

119. Hold the landing gear in position on the bottom of the fuselage, 1/8" from the back of the 12" Lite-Ply bottom piece and drill 7/64" holes into the fuselage interior.

120. Use a long 5/32" drill or a piece of 5/32" music wire to enlarge the holes on the inside to accept the blind nuts.

121. Bolt the landing gear in place and pull the blind nuts into the wood, using epoxy glue to hold them in place. Brace LGP to the sides with pieces of scrap wood.

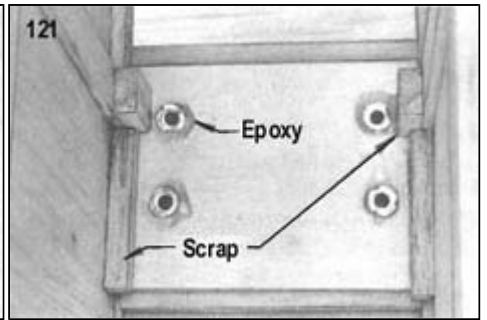
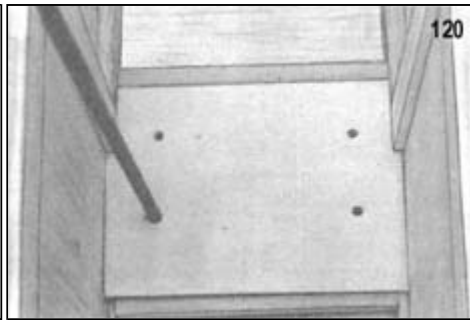
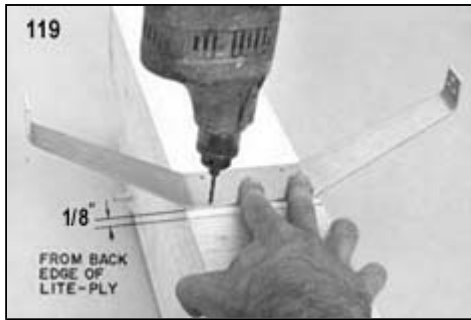

## NOSE GEAR INSTALLATION

The wheel collar suggested as optional for the nose gear is not furnished. File or grind a notch in the collar so it will fit down on the coil farther. The collar permits altering the height of the nose gear slightly if desired (see instructions further on in this change sheet about adjustments to nose gear height.) Don't try to make large adjustments in nose wheel height with the wheel collar because the landing gear is more easily bent on a hard landing if the coil spring is located very far below the nylon nosewheel bracket. Large adjustments should be made by changing the wheel size.

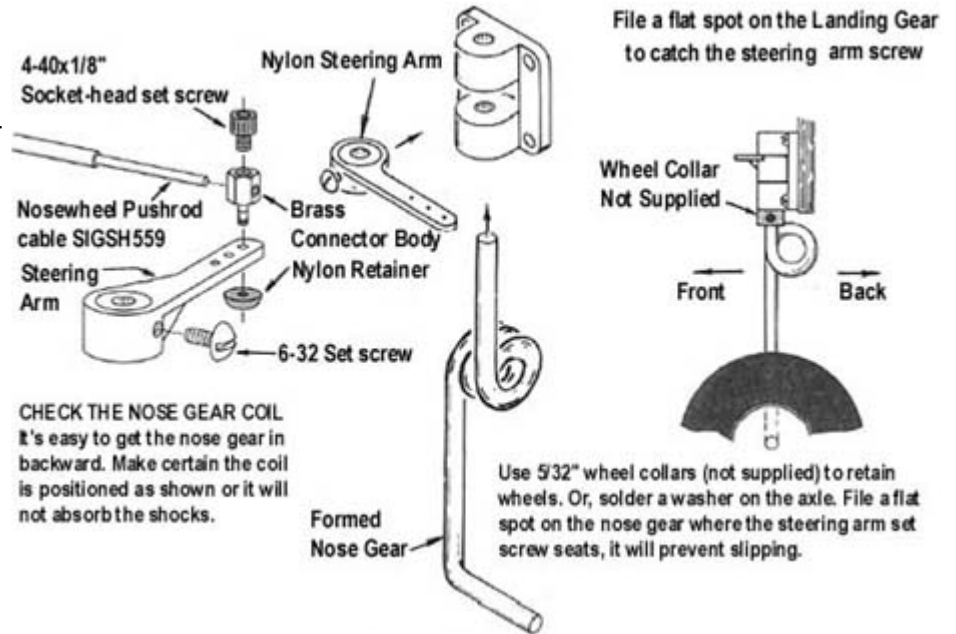

122. Round the fuselage corners using a razor blade or modeling knife, then finish up with a sanding block.

123. Round the tail end of the fuselage to a smooth contour.

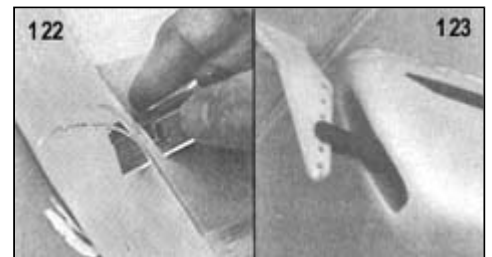

## COWLING INSTALLATION

124. To make openings in the cowl for the engine, first drill a series of holes about 1/8" in diameter around the area to be removed. Cut through the bits of plastic between.

- 125.
- Remove the carburetor from the engine during the initial stages and work with the cylinder head hole.
  - Cutting a slit out the back of the cowl from the head hole can be of assistance, but if care is used the task can be accomplished without the slit.
  - Start the hole undersize and open it up slowly, fitting as you go so it doesn't end up larger than necessary.

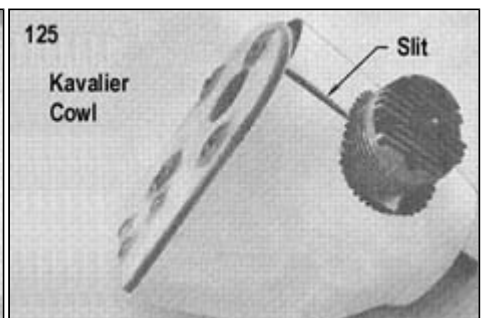
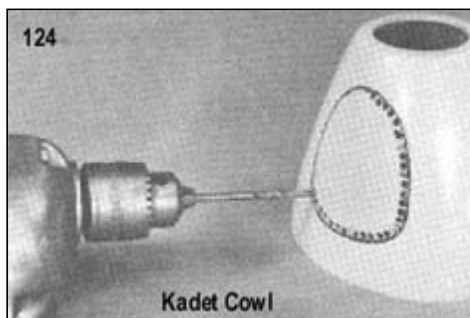

126. The best way to open up the hole is to go around the edges with an "apple-peeling" motion, paring off a small amount of plastic with each stroke.

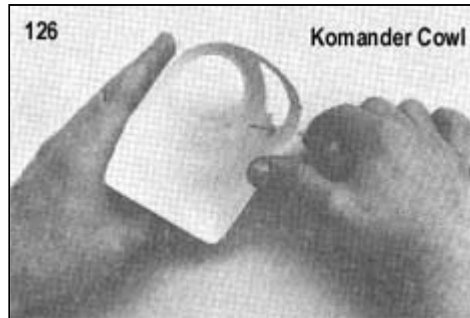

- 127.
- Cut the hole for the carburetor last.
  - Round all of the corners.
  - Put the spinner backplate on during final cutting check exact cowl position.



128. After the fuselage construction is completed, the cowl may be mounted.

- Epoxy the hardwood cowl blocks to the firewall.
- Place the cowling in position and put on the spinner backplate.
- Tape the cowl in place and drill small pilot holes into the blocks for the screw locations.
- Enlarge the holes in the cowling only to pass the No.4 screws.

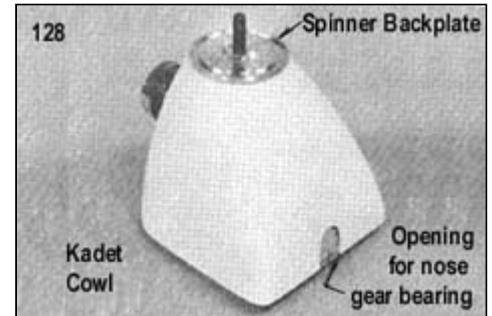

(A hole in the front of the cowl to allow screwdriver access to the L. G. set screw is handy. It permits on the field adjustment of the nose gear without removing the cowl.)

NOTE: A Kadet builder has suggested use of a Zona Sabre Saw for the cowl holes.

## TAIL CONSTRUCTION

129. Cut out the tail parts on a jig saw or with a modeling knife. Don't cut too close to the lines.

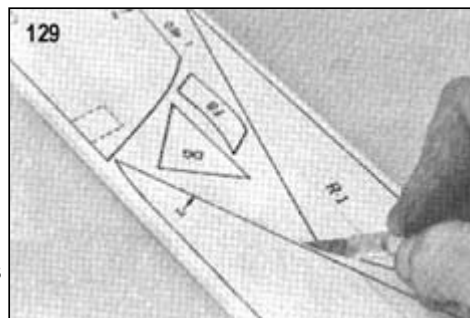

130. Sand down to the outline.

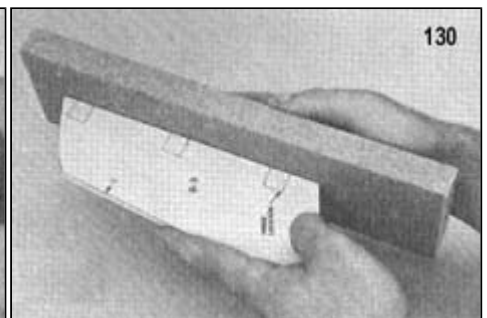

131. Glue the fin parts together.

132. Sand off the lines and smooth both sides of the fin.

133. Round the front edge of fin. Do not round the trailing edge or the bottom.

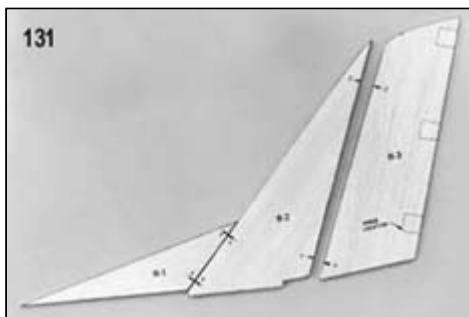

134. Pin pieces of 1/8"x3/8" balsa strip on the stabilizer plan.

135. Cut and glue crosspieces of 1/8"x3/8" strip.

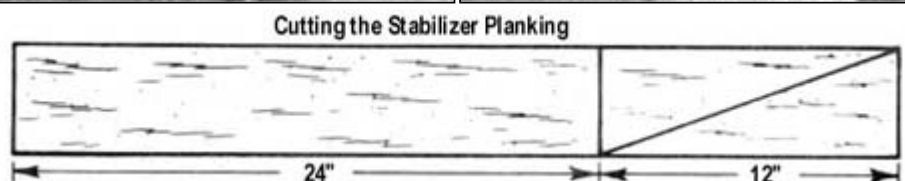

136. When the frame is dry, sand smooth with the sanding block.

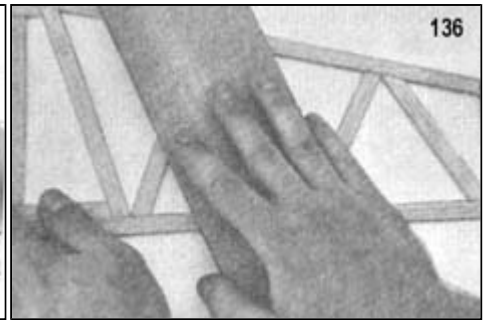
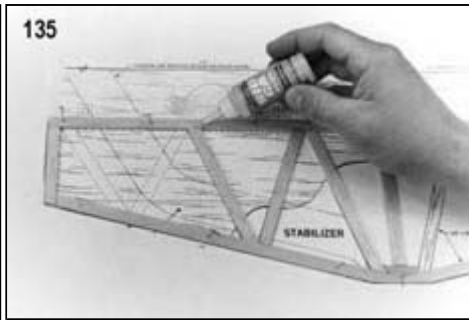
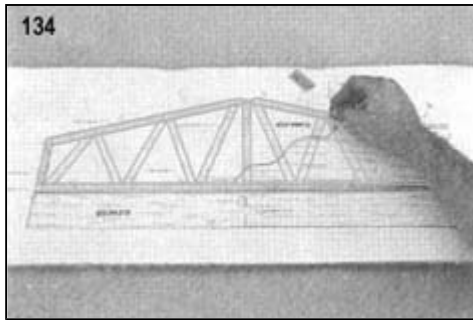

137. Pin a strip of 1/16"x3" balsa planking to the stabilizer. Do not wait for it to dry completely, proceed to Step 138.

138. Cut a piece of planking to fit the remaining area and glue it in place. Do not wait for the glue to dry completely. Let it dry a few minutes to get a grip on the parts, remove the pins and turn the stabilizer over on the building board. (This speeded procedure helps insure a flat, true stabilizer.)

139. Repeat the process on the other side, first with a strip of 1/16"x3" balsa, then the front tapered piece.

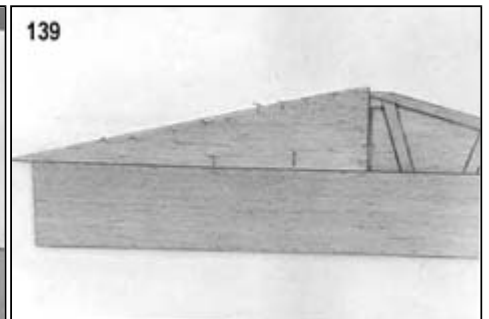
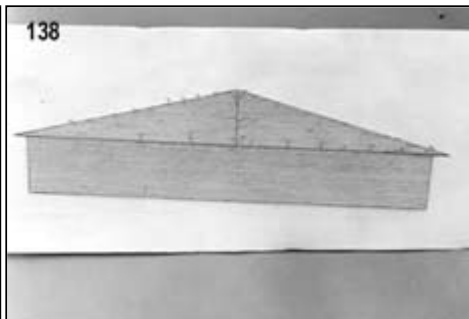
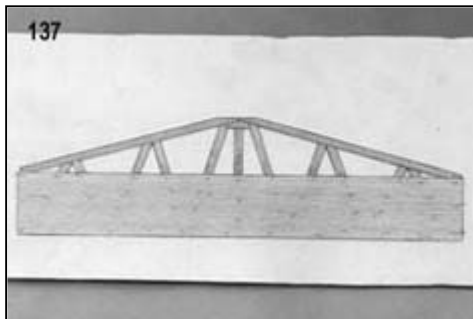

140. After the second short piece is added, leave the stabilizer pinned down until it is completely dry.

141. Sand the stabilizer smooth with a sanding block. Round the leading edge in the same manner as the fin was shaped previously. Also round the leading edges of the rudder and stabilizer to prepare them for covering.

142. At this point, most modelers prefer to cover the fuselage and tail pieces before proceeding with the remaining construction steps (steps 142 thru 148). This is particularly recommended if you plan on covering with plastic film. Once covered, the tail surfaces can be hinged with EASY HINGES using the instructions mentioned earlier. The photos show the parts uncovered for clarity. To glue the stabilizer in place, begin by positioning and pinning it accurately on the fuselage (see the General Alignment Diagram on page 20 of "The Basics of Radio Control"). When satisfied with the alignment, draw cut lines on the bottom of the stab at the fuselage sides. Remove the stab and using a sharp knife, carefully cut away the covering (try not to cut into the wood) where the stab will contact the fuselage. There must be wood-to-wood contact at this joint. Use Kwik-Set epoxy to glue the stabilizer in place.

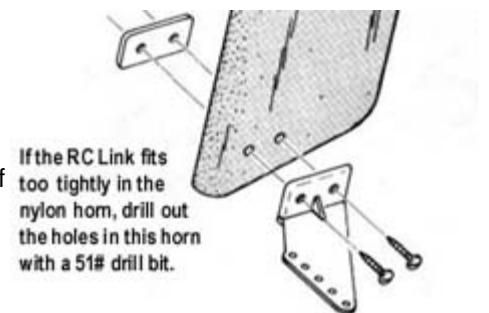

143. Install the nylon control horns.

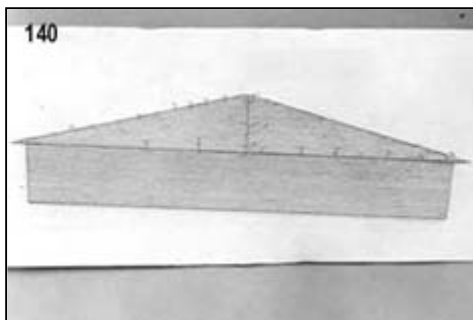

144. Cut or file off the ends of the horn screws.



145. Draw a centerline on the fuselage and mark the cutout required for the fin tab slot.

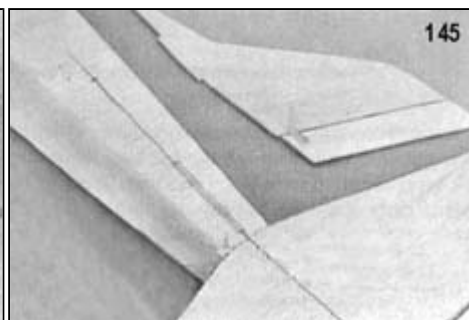

146. Cut out the slot.

147. The fin fits into it.

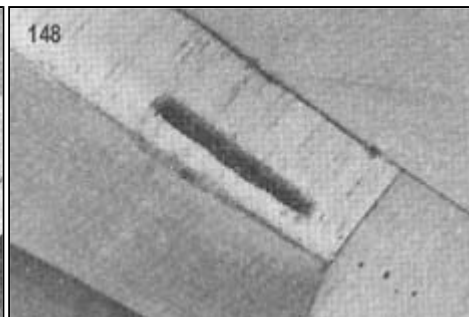
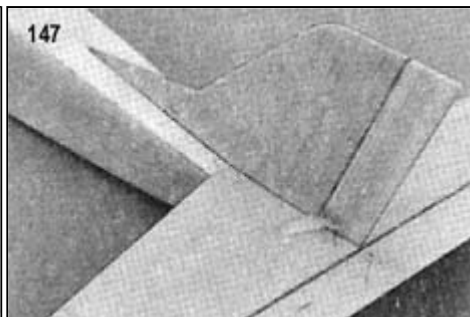
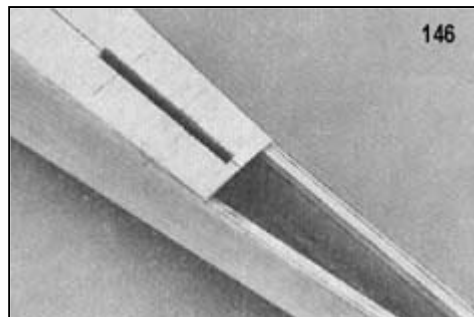

148. Cut out a slot for the pushrod exit.

NOTE: Make certain that the fin is firmly epoxied to the fuselage top as well as in the fin slot.

If desired you can add a nylon pushrod guide (not furnished). The elevator pushrod exits through the opening in the fuselage rear. Open it up as required to pass the pushrod. The pushrod wire may be bent slightly if it tends to rub on the fuselage.

Take note that the elevator horn arm is centered on the elevator, not the horn mounting holes, which must be offset to locate the arm in the center of the fuselage opening. (See photo 143.)



## COVERING AND FINISHING

There is a variety of covering and finishing methods available that are well suited to the Kadet Mark II. The final choice should be made after reading through each part of this section so that you can make an informed decision. Plastic iron-on coverings are popular because they are fast and easy to apply. Sig Koverall will give the model the strongest and most durable finish; while materials like silk, silkspan, and silray will appeal to the more traditional modeler

**IMPORTANT!** If you plan on using a finishing method that requires painting (Koverall, silk etc.) don't skip covering the fuselage and tail just because they are solid wood. Painting them without covering first is not enough. They will be much more resistant to splitting and breaking on hard impacts if covered, than painted.

Regardless of which covering you decide to use, it will not conceal a rough framework. Take the time to sand the model carefully with fine sandpaper (360-400 grit) before beginning to cover.

### COVERING WITH SILK, SILKSPAN, OR SILRAY

Although we refer to silk in the directions, all of these coverings are applied wet in the same manner as follows. Brush an unthinned or very lightly thinned coat of clear Sig Supercoat or Sig Lite-Coat Dope over all parts of the framework that will contact the covering. When dry, resand with fine sandpaper to remove any fuzz or raised grain. Brush on a second coat and sand again.

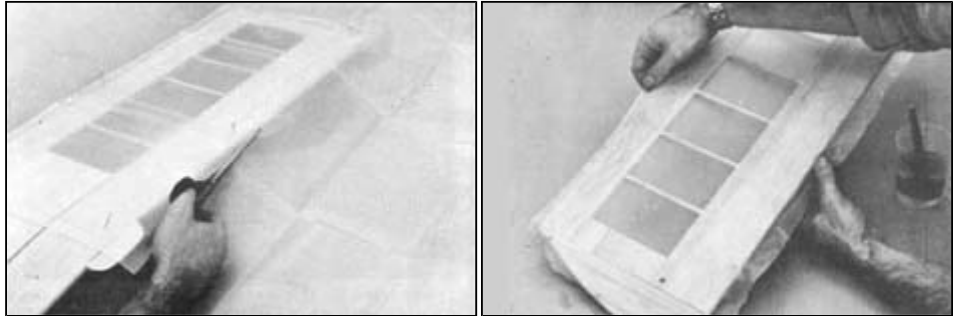

The bottom of the wing is a good place to start covering. Cut a piece of material about 1/2" larger all around than half the wing, with the grain running lengthwise. (The grain of woven materials runs parallel to the finished bias edge.) Some builders next dip the piece in water and apply it to the wing. We find that the silk sticks together and takes a lot of pulling and smoothing to get it in place so we do it a bit differently, as shown in the photo. Pin the dry covering in place and "paint" the water on with a brush.

Go around the edges, pulling out wrinkles and stretching the material smooth. You need not pull it up drum tight, in fact going to this extreme is not advisable. Just pull out all of the wrinkles. Use pins, if necessary, to hold the silk smooth, though wet silk usually stays in place without too much pinning.

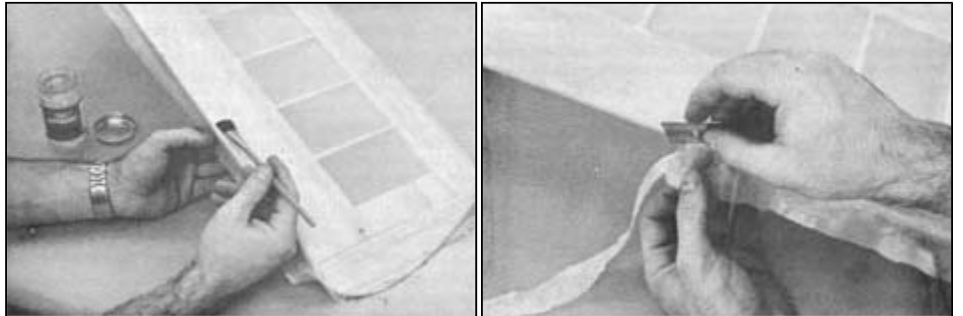

We like to fasten one end - in this case the upper center joint of the wing - pretty firmly with pins so that you can pull against this anchored end in stretching the silk the long way.

Brush around the outside edge of the stretched silk with clear dope. The dope will soak through the material and adhere to the dope already dried into the framework.

Trim off the edges with a sharp blade. We find a thin double-edged razor blade is ideal for this, but a single-edged blade does okay and you can't cut your fingers on it. On the bottom, trim off flush with the wing all the way around. Go over any rough area or places that have not stuck down properly with more dope and press the loose spots down as the dope is drying and getting stickier.

The top half is done in identical fashion except that the silk should be brought down over the edges instead of being trimmed flush. On the front, lap the silk over the edge of the bottom, over-lapping about 1/8". At the back, bring the material down over the back edge of the trailing edge but do not lap it over the bottom covering.

Use the same process on the tail section and fuselage.

Allow the water to dry out of the wood before applying the first full coat of clear dope. On the open framework area on the wing, brush the dope on sparingly. If too much is applied, the dope will be rubbed through the material and will run down the the surface on the inside and form a puddle. When these puddles dry, the large amounts of dope solids in them cause more shrinkage than the rest of the covering and a scarred area results. So apply dope very lightly the first time over. A second coat will seal most of the pores of the material and from this point, running through will not be a problem.



#### **A Cure For Fuselage Warping**

Use one or two coats of regular Supercoat clear on the wing to shrink the covering. After that, unless the covering is still not tight and unwrinkled, Sig Lite-Coat low shrink dope is recommended to help prevent warping. The solid wood fuselage and tail can have Sig Lite-Coat from the beginning if desired. Sig Supercoat Color Dope has low shrinkage qualities.

You may have noticed that when a piece of balsa is doped on one side and not on the other, it will curl. The same thing can happen on the fuselage sides under the wing opening, particularly when you put on a number of coats. (The rest of the fuselage will not show this effect to any extent because it is four sided and cannot distort.) The effect isn't noticeable until after full cure of the dope and aging, which may take several months. To prevent this from happening, give the inside of the fuselage a coat of dope every time you give the outside a coat. This has an added advantage in making the cabin area fuel proof. In addition, when the hardwood servo mounts are installed, have them a little over-long so that the cabin sides are bulged slightly outward.

A third coat of clear should provide a good base for color. Sand lightly when dry with 360 grit 3M Tri-M-Ite no-load paper. Don't bear down on the edges of the ribs or the silk fibers will be cut through. The color dope may be brushed or sprayed.

Supercoat Color Dope should be thinned with Supercoat Thinner for brushing. This helps prevent brush marks and gives smoother coats. Flow on wet coats and avoid rebrushing back over an area already painted. If brush marks show, you need more thinner. For spraying, thin dope about 50-50. Add more thinner if the dope does not go on evenly.

If high humidity causes the dope to "blush" or turn white, the best way to handle this problem is to wait until the humidity situation improves and apply another coat of dope. This will eliminate the blush. If it is necessary to dope during high humidity, Sig Retarder may be used in place of part of the Supercoat thinner (amount depends on the humidity) to reduce the tendency to blush.

Painting the entire model white is recommended for a good color base, particularly when white is part of the color scheme. Color coats can be sanded with 360 Tri-M-Ite or 400 or finer wet paper. When using masking tape for trimming, seal the edge with a coat of clear dope to prevent the color dope from bleeding under the edge. Don't leave the masking tape on any longer than necessary. The longer it is on, the harder it sticks.

The original Kadet Mark II was given 2 coats of sprayed Sig Supercoat white. The windows and decoration scheme was then traced on with a soft pencil and the design covered with masking tape. Two coats of Sig Supercoat light Red were then sprayed on. When the masking tape is pulled off, the design will probably not have perfectly even edges. if you do not wish to pin stripe it with a ruling pen and dope, as described in the next paragraph, use the pen to touch up the edges.

The pin striping was applied with a mechanical drawing ruling pen. Thin the dope slightly with blush retarder to slow the drying process and aid the flow of dope through the pen points. Clean the pen frequently with dope thinner and wipe on a cloth before reloading with fresh dope. Don't try to draw a thick line with the dope and pen but instead draw a thin line on each side of the desired pin stripe (about 1/8" wide were used on the original) and fill in between the lines using the pen free hand and opened up for a wider flow. If you have a steady hand, use a small brush. Use a French curve to outline curved parts of the decorations. The cabin windows were painted silver.



Complete the job with several sprayed coats of clear over the color scheme. This seals the colors and adds gloss. For best results, it is not a good idea to try to mix different brands of paint Use SIG products from the start.



## FINISHING THE PLASTIC COWL

The plastic cowling may be painted with Sig Supercoat Dope. Care should be used not to apply heavy, wet coats of dope. Put on light coats and allow them to dry thoroughly before applying a second coat. A spray gun is a good method of getting a good finish with a minimum amount of dope. Be especially careful with spray cans not to wet the plastic too much. Spray several light dusting coats with adequate drying time allowed. Plastic may also be painted with Sig Plastinamel, Sig Skybrite, K&B Superpoxy, Hobbypoxy or Du Pont Dulux Enamel. Don't use other paints without testing first on scrap plastic.

CAUTION: Do not try to cover the cowl with any type of iron-on covering. The heat may melt or distort the plastic.

## DECALS - Stik-Tite Pressure Sensitive

Cut out the decals with a pair of sharp scissors. Leave about 1/32" to 1/16" of clear edge around the decal. Round the corners as you are cutting. Wet the surface on which the decal will be placed with soapy water (use dishwasher detergent). Place the decal on the model and squeegee the water from underneath with a balsa paddle. Allow to dry. This procedure will prevent air from being trapped underneath as is possible when the decals are applied dry.

## COVERING WITH SIG KOVERALL

Sig Koverall is a relatively inexpensive, synthetic polyester-base, heat shrinkable fabric much like the covering used on full-scale aircraft. It is the strongest and most durable finish you can use on your Kadet - it will actually add strength and rigidity to the model's framework. If you are careful in cutting the material, one medium sized package (SIGKV002, 48"x72") is enough to cover all the parts of your Kadet. It can be applied to the model using dope or ironed on using Stix-It, a heat-activated adhesive.

### Surface Preparation

Whichever application method is used, you should first brush two coats of clear dope onto the framework wherever the covering material makes contact. Lightly sand after each coat to remove any raised grain or fuzz.

### Applying Koverall With Dope

Start with the bottom of the wing by cutting out a piece of material about 1/2" larger all around the panel, with the grain running spanwise. (The grain of Koverall runs parallel to the finished bias edge.) Lay the Koverall on the wing, pulling out any major wrinkles. Unlike silk, which uses water to shrink it tight, Koverall uses heat. In fact Koverall shrinks so well that there is no need to worry about such things as packaging folds or creases because they will come out easily with the iron. Brush clear dope around the edges. This will soak through the fabric and adhere it to the dope already dried into the framework. Allow dope to dry before trimming off the excess material with a sharp razor blade. Check for any rough edges or places that are not stuck down properly and apply more dope. Let dry.

### Applying Koverall With Stix-It

Directions for applying Koverall with Stix-It are on the can. The basic procedure is to apply Stix-It around the edges of the framework where you want the covering to attach. When dry, the fabric can be ironed-on around the edges where the Stix-It was applied.

### Shrinking and Sealing Koverall

After both sides of the surface are covered (such as the top and bottom of the wing), shrink the Koverall evenly with an iron or hot air gun. (Be sure to read the Koverall package instructions.) The fabric can now be sealed with three or four coats of clear dope. Since Koverall has such a tight weave, fewer coats of dope are necessary to fill it than silk. Thin the dope until it brushes on easily and flows out smooth (about 25% to 30% thinner). The first coat should be applied sparingly to avoid puddles underneath the fabric. The second coat will seal most of the pores of the Koverall and from then on, running through will not be a problem. Sand the model VERY LIGHTLY with FINE sandpaper after the second coat is dry. The next two coats will completely seal and begin to fill the weave of the fabric. When dry, sand again. Your Kadet should now be ready for its colored paint scheme.

### Painting

Apply the colored dope to the Koverall exactly as described in the "COVERING WITH SILK, SILKSPAN, OR SILRAY" section, starting with the white base coats.

## COVERING WITH SIG SUPERCOAT IRON-PLASTIC COVERING

Many modelers prefer to use an iron-on plastic covering on their models for several reasons. Some modelers simply don't like to paint or have workshops located where paint fumes can't be tolerated. Others like the speed and ease of application afforded by plastic coverings.

You can generally finish a model much faster using an iron-on covering rather than a painted finish. However, plastic coverings are less durable and do not add nearly as much strength to the structure as fabric covering. On the plus side, plastic coverings are fairly easy to apply and result in a glossy, smooth finish. Plastic coverings tend to be susceptible to punctures and tears, but they are easily repaired.

If you decide to cover your model with this type of material, we recommend Sig Supercoat Iron-On Plastic Covering for its low cost, light weight, and ease of application. To cover the Kadet, you will need at least four rolls of Supercoat. You can use one color for the wing and another for the fuselage, or go with all one color. Two pages of photo illustrated instructions are supplied with each roll of Supercoat, so only a quick outline will be presented here.

### Surface Preparation

Like any other type of finish, Supercoat will not hide poor workmanship. The entire framework should be given a final sanding with 360 or 400 grit sandpaper before application of the material. Wipe the surface with tack rag or cloth dampened with alcohol to remove all excess dust.

### Covering The Wing

Cut a piece of material slightly oversize, remove the protective plastic backing sheet, and lay the adhesive side of the covering material against the structure. Tack the material in place around the edges using and iron to activate the adhesive. Seal the entire edge, then trim off the excess. Repeat this process for the top of the wing, being sure to overlap the material about 3/16" to 1/4". Always plan your covering sequence so that seams are on the bottom surface or at corners so they aren't so easy to see. Once both top and bottom have been covered, shrink the material with an iron or heat gun, heating evenly from one side to the other.



### Covering The Fuselage

Cover the bottom, the two sides, then the top using separate pieces of material for each. When covering solid surfaces like the fuselage nose, better results may be obtained by starting at the center and working towards the outer edges. This allows the air to escape from under the covering as it is applied. Some modelers prefer to cover their tail surfaces before gluing them to the fuselage so that they are easier to handle. Be sure to cut away any covering where the surface attaches to the fuselage so that you have a strong wood to wood joint.

### Finishing Touches

Once your model has been covered, you can add trim decorations using Sig SuperTrim Self Adhesive Trim Sheets. SuperTrim is made of the same material as Supercoat, but it has a sticky backing. Simply cut out your design and stick it in place. Thin strips can be cut from SuperTrim sheets or you can use one of the many brands of striping tape (such as Sig SuperStripe) which come in various colors and widths. Be certain to add some kind of stripe or decoration to the top of the wing so that while you are flying it is easy to distinguish the top of the airplane from the bottom.

## PRE-FLIGHT CHECKOUT

---

NOTE: The remainder of these instructions concerning Pre-Flight Checkout and Flying contains information specifically concerning the Kadet Mark II. At this point, you should refer to the booklet "Basics of Radio Control" included with your kit for more information on balancing, control throws, and other items that are important to the success of your model. In particular, go through the "Pre-Flight Checklist" in Chapter 7 carefully before attempting to fly.

## BALANCING

Kadets will be okay for test flying if their balance is somewhere within the indicated range. Our own Kadets are balanced in the forward position and seemed quite happy that way. It is probably safer for beginners to have the balance point forward, at least on test flights. Tail heavy Kadets have a tendency to not react quickly to aileron movements in slow speed and/or nose-up situations.

Do not fly with the balance point behind the range shown unless you are an expert flier with a definite purpose (such as extreme aerobatics) for doing so.

SUGGESTION: For test flights, put a piece of masking tape on the bottom of each wing tip and mark the Balance Point range on the tape. This will make it convenient to check the actual balance point location and adjust it as desired.

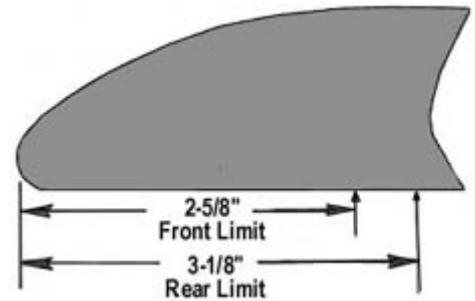

The balance point range is measured from the leading edge of the wing. Suspend the model on finger tips placed on the bottom of the wing on the marks. Balance with an empty fuel tank, but with all other equipment installed and the model completely finished and painted. It should hang from the finger tips approximately level.

If the tail hangs down, it is tail heavy. Add lead or weight to the nose as necessary to get it to hang level. Be sure and fasten the weight securely. Do not attempt flight in tail heavy condition.

If the nose hangs down below level, the model is nose heavy. If it is only a little nose heavy, don't do anything about it, it will be okay to go ahead and test fly. If it is more than a little nose heavy, correct by moving the radio batteries out of the nose and as far back in the cabin as is necessary to achieve balance.

## CONTROL MOVEMENTS

Control measurements below are suggested as a beginning. Test flights may indicate a need for more or less movement, depending on individual model differences, center of gravity (C.G.) location, your personal preferences, etc

(Flight Tests may determine that the neutral point should vary slightly from level but for purposes of illustration the neutral point is shown level.)

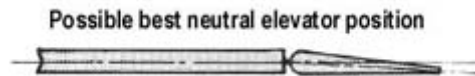

It is not uncommon for the best Kadet elevator neutral position to test out to be slightly drooped down from level. This introduces some nose down trim to keep the model from climbing when the transmitter stick is in the center. The exact best neutral elevator position for each particular model must be determined during flight testing.

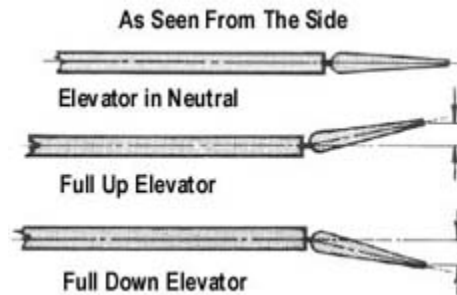

RECOMMENDED ELEVATOR MOVEMENTS	
Beginner's	3/8" UP and 3/8" DOWN
Sport Flying	7/16" UP and 7/16" DOWN
Aerobic Movement	9/16" UP and 9/16" DOWN

With the model flying at about 3/4 throttle, feed in down trim with the transmitter lever until the model flies level. Land and observe the position of the elevator. Adjust the elevator push rod as required to keep this flight checked "neutral" position when the transmitter trim lever is returned to the center.

Aileron movements are approximate. Differential between up and down movement may vary in individual installations but it is not a critical matter, as long as you have more up than down movement with at least as much difference between the two as shown in the table.

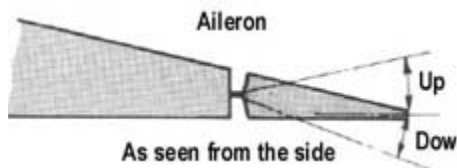

RECOMMENDED AILERON MOVEMENTS	
Beginner's	3/8" UP and 5/16" DOWN
Sport Flying	7/16" UP and 3/8" DOWN
Aerobic Movement	1/2 to 9/16" UP and 7/16" to 1/2" DOWN

If the ailerons should need offsetting from neutral to correct wing warp, try setting the neutral point of the ailerons slightly above level and use the "up" side of the movement for required corrections more than the "down" side of the movement. It is not a good idea to have the aileron drooped down below level for adjustment of trim in either aileron if it can be avoided.

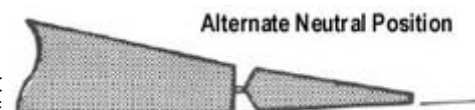

## Optional Aileron Gap Seal

Too wide a gap at the aileron hinge line can cut down on their effectiveness due to pressure leakage through the gap. Sealing the gap with plastic tape or a strip of plastic film covering material will make the ailerons more effective, even on a model with a small gap. (The factory Kadets were flown with unsealed gaps to establish the recommended control movements listed here.) While this suggestion will help insure that the ailerons are effective, the primary means of controlling roll response is still by adjustment of the aileron movement. If your Kadet will not turn or roll to your satisfaction, it is most likely due to an inadequate amount of up and down movement of the ailerons.

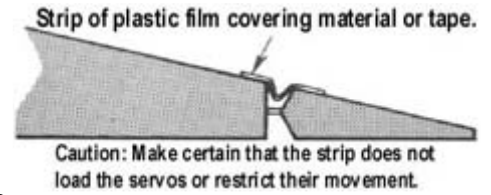

The adjustable nylon fittings on the aileron horns (supplied with the kit) provide a fairly good range of aileron movement adjustment. Screw the nylon fitting in toward the wing for increased movement of the ailerons; out away from the wing for decreased movement. After raising or lowering the fittings, chances are you will need to readjust the neutral point of the ailerons using the adjustable RIC links on the aileron push rods.

## Optional Aileron Servo Hookup

The aileron horns are offset for differential movement as much as is practical without striking the fuselage structure during movement. Some of this offset is cancelled out when the adjustable nylon fittings are added. A method of getting a better differential - the alternate neutral position is described above and this helps the situation. However, the best way to increase differential is by offsetting the pickup point on the servo for the pushrods as shown in the accompanying drawings. Any amount desired can be obtained in this manner. The farther up the wheels the push rods are attached, the greater the differential, i.e., more up, less down movement.

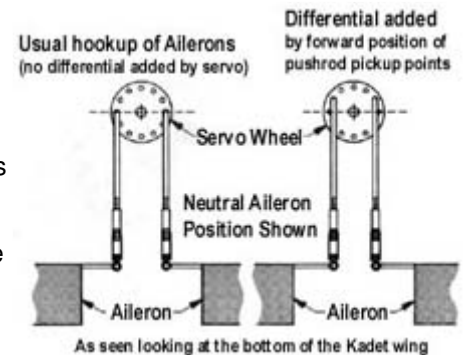

We suggest the use of DuBro Ball Link fittings on the servo wheel but they are not shown on the drawing for clarity. Kadet fliers who are using this approach suggest starting with about twice as much up as down. For example, 1/2" up would be accompanied by 1/4" down. This exact proportion of this relationship is not critical, since the Kadet flies very well without any differential at all, but improved turn characteristics are said to be had by this setup of the servo.

If your fin should be glued on slightly crooked and thus causes the model to turn one way or the other, use offset of the rudder to correct the tendency. Do not use aileron offset to correct turns caused by the fin. Aileron offset should only be used to correct wing misalignments.

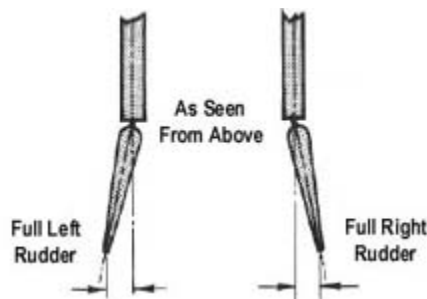

<b>RECOMMENDED RUDDER MOVEMENTS</b>	
<b>Beginner's</b>	5/16" LEFT and 5/16" RIGHT
<b>Sport Flying</b>	7/16" LEFT and 7/16" RIGHT
<b>Aerobatic Movement</b>	9/16" LEFT and 9/16" RIGHT

## FLYING

### Flying the Kadet MK II on Three Channels when using a Four-Channel Radio

Plug the rudder servo in the fuselage into the receiver outlet marked aileron. If an aileron servo is installed in the wing, leave it unplugged and tape the ailerons in place so that they cannot be bumped and moved off of center. Use of the aileron stick on your radio equipment to operate the rudder will enable you to develop the proper left and right reactions that will later be needed when advancing to aileron control, using the same hand. If you plugged the rudder into the rudder socket when only using 3 channels you would have to make a difficult transition from one hand to the other at the time you advanced to aileron control, just about the same as starting over. The most important thing you are learning in the early stages is an automatic left and right reaction on a particular transmitter stick with a particular hand. Forget which control surface is doing the turning on a 3 channel Kadet MK II, assume that the rudder is an aileron.



## Flying the Kadet MK II on Four Channels

Plug all controls into the receiver outlets as marked. The rudder is now on the left hand stick and, on an aileron model, will only be used for ground steering and certain aerobatic maneuvers. If you started flying on 3 channels, practice taxiing the model around on the ground to help make the transition from the right hand operation easier. In the air of course, you will be using the same turn motion you have practiced as a 3 channel flier.

## Flying the Kadet MK II on Two Channels

3 or 4 channels are best, but the Kadet can be flown on 2 channels when this is necessary. We recommend use of rudder and elevator control for the two channels. Motors above .25 cu. in. in size should be run throttled back to about 3/4 power by tying down the throttle arm at the desired speed. .25 cu. in. motors can be run wide open. Altitude gain on two channels is controlled by use of elevator down trim or application of down elevator stick movement when required. On first test flights with a 2 channel Kadet, fill tank 1/2 full. This will help keep the model from gaining too much altitude if the trim is not set properly at first and the rate of climb is excessive.

## General Flying Tips

Test flying and flight trimming are covered thoroughly in the "Basics of Radio Control" booklet. Read those sections carefully, especially if you are a first-time pilot. No amount of reading material or pre-flight discussion can totally prepare you for the actual experience of handling your model in the air, but knowing what to expect will make it much easier.

We highly recommend that you try to find an experienced R/C pilot to help with your first flights and serve as an instructor while you are learning to fly. Have the instructor make the first flight on the model to get it trimmed out and to make sure everything is working okay.

The Kadet MK II can takeoff from paved runways or smooth grass, but these aren't always available. If a good, smooth takeoff surface isn't available, the model can be hand launched by the pilot's assistant. (Do not attempt to hand launch by yourself - instant action on the transmitter may be required.) Holding the front part of the fuselage with the left hand and under the tail with the right, run into the wind at a fast trot and thrust the model forward with the nose slightly up in a spear throwing motion. It is not necessary to achieve a lot of velocity in the launch - it is more important that it be released smoothly with the wings level. The model may dip slightly and then begin climbing at a slight angle. If it does not begin to climb after about fifty feet of flight, apply a small amount of up elevator to lift the nose.

## Don't Wallow Around The Sky!

A common mistake made by beginners is to fly around with the model having too much up trim. It climbs out steeply under full power in this condition (and is probably a safety factor for a rank beginner) and you can level it off by throttling back on the motor. However, in this over-up condition, it wallows around with the nose high, it is hard to turn properly and it will not fly into the wind because of low airspeed. The solution is to apply some down trim to the elevator to bring the nose down and make the model fly more nearly level at cruising power. It may be necessary to droop the elevator a bit from level by screwing in the RC link on the elevator pushrod to get enough down. The way to learn how to do this trimming process is to experiment with the model in the air and note it's reaction to increased down trim or other changes. Moving the center of gravity in combination with trim changes can also alter the flying characteristics. For example, you may find that the balance point specified for test flights will be okay for the first few flights but when the model is trimmed down to fly more level under cruising power you may find that moving the balance point back will give you better performance. Or you may find reactions to aileron movements improved by keeping the balance point forward and using more aileron movement.

It is impossible to give exact directions for every case, since individually built models vary slightly and the engine used also affects results. But if the model is not flying in a satisfactory manner, the chances are it is not trimmed properly and should be adjusted accordingly. Do a little tinkering, a bit at a time. This is an instructive way to fathom the mysteries of perfect trim and in the process you can improve your flying performance considerably.

### **Warning - Danger! Important: Read These Warnings:**

Do Not fly control line or towline models within 300 feet of electric power lines. Instant death from electrocution can result from coming near them. Direct contact is not necessary. A model airplane motor gets very hot and can cause serious burns. Do not touch the motor during or after operation. Keep clear of the propeller. It can cut off a finger or put out an eye. Make sure the propeller is securely fastened in place and is not cracked. Model airplane fuel is flammable and poisonous. Take the same precautions while transporting and using it that you would with a can of gasoline or a bottle of poison. Remember that it is possible to lose control of a model airplane. Do not fly in locations where the model may hit people or damage property if loss of control occurs. Check your model and equipment regularly to insure it is in safe operating condition.

© Copyright SIG Mfg. Co., Inc.

**SIG MFG. CO., INC.....Montezuma, Iowa 50171-0520**

**LIMIT OF LIABILITY:**

In use of our products, Sig Mfg. Co.'s only obligation shall be to replace such quantity of the product proven to be defective. User shall determine the suitability of the product for his or her intended use and shall assume all risk and liability in connection therewith.