

KADET SENIORITA



BUILDING AND FLYING INSTRUCTIONS

CRAFTSMAN'S KIT RC60

The Kadet Seniorita basically follows the philosophy of our other models in the Kadet Trainer series that preceded it- a stable, high wing design using a flat bottomed airfoil. In addition, and extra feature, introduced in the Kadet Senior, is an unusually low wing loading, achieved by increasing the model size for the recommended engine range and simplifying the structure. Also featuring increased dihedral and large tail surfaces, the Seniorita is more of a "hands off" flier than the Kadet MKII for example, but because of this, is not as suitable for use with ailerons and does not need them for excellent performance. The light weight means the Seniorita cannot be as rugged as the Kadet MKII. So until you are a proficient pilot, don't fly in winds over 10m.p.h. or in a field with obstructions to run into, or from a bad surface that will cause cartwheels on landing. The Kadet MKII, with its heavier construction, is better suited to knockabout flying. But the best approach, in our opinion, is not to choose between the Seniorita and the Kadet MKII, for example, but to make use of both. Start with the slower Seniorita to develop confidence and automatic reactions. Then go on to the Kadet Mark II for graduation to aileron control. The only transition between the two airplanes is minor, which can be quickly by-passed with a little ground taxiing experience to get used to steering the nose with a different hand.



Radio Equipment Requirements

Selection of radio equipment should be based on the amount of money you wish to spend, the type of airplanes you intend to be flying and your future goals. If you plan to stay in the hobby and work up to larger airplanes with complete controls, it might be best to consider the purchase of a four, or more, channel set in the beginning, even though the Seniorita is flown on fewer channels. This would eliminate the necessity of disposing of an initial investment in beginner's equipment of less than 4 channels and buying a new set when your flying skills are ready for an advanced model. Equipment with nicad rechargeable batteries is strongly recommended. Dry cell operation is cheaper initially but the money saved is soon wiped out buying replacement dry cells. Nicads are safer, since you go out flying with a full charge and don't have to worry about losing control from dead batteries.

Engine Size

We are of the opinion that RC trainers should have adequate power for such things as grass field takeoffs, beating their way upwind, etc. Therefore fairly large engines are recommended. For cruising around and learning to fly, throttle back with the knowledge that power is available when needed. Engines larger than those listed on the box lid are not recommended. Use of oversize engines may overload the airframe. Remember that a muffler will reduce engine power and allowance should be made for this. If you live at high altitude, engines will not develop power equivalent to that delivered at sea level.

About The Building Sequence

The quickest and most efficient way to complete a model is to work on several pieces at the same time, such as the front and rear of the fuselage. We occasionally get suggestions that our instruction guides should be in exact step-by-step building sequence. But this would result in many sentences starting, "While the glue is drying on the fuselage, move to the wing ...etc." and a lot of jumping back and forth between assemblies with no consistent pictorial progression. Also, a pre-selected building sequence by our choice might not suit your workshop space and time allotments. Therefore we feel the present system of covering main assemblies in a unit works out best for the majority of kit builders. So keep in mind that the numbering sequence used in this guide was chosen as the best way of explaining the building of each major assembly and is not intended to be followed on exact one-two-three fashion. Start on the wing at No.1 and after doing as many steps as convenient, flip over to the next main heading "FUSELAGE CONSTRUCTION" and do a step or two there, then over to "TAIL SURFACES" and so forth. You will, of course, arrive at points where you can go not farther until another component is available. For example, you need a nearly completed wing before the fuselage can be entirely completed. And you will need both the wing and the stab to fit the wing and tail saddles on the fuselage and align them to each other. The way to understand these relationships is to read these instructions completely and study the full size plans before beginning to work. Think ahead! Any reference to right or left refers to right or left as if seated in the cockpit.

Refer To "THE BASICS OF RADIO CONTROL"

In addition to the instructions you are reading now, the publication "The Basics of Radio Control" has been included with this kit as a reference for installing the engine, fuel tank, and radio in the Kadet Seniorita. It also contains very important information on preparing the model for flight. Modelers of all experience levels are encouraged to read this publication and follow its guidelines for success.

Some Building Suggestions

Cut all long pieces of balsa first, followed by medium lengths, before cutting up any full-length strips into short pieces. Protect the plan with wax paper or plastic wrap under the assemblies. A piece of Celotex-type wallboard or foam board makes a handy building board, into which pins can easily be pushed. Lay the building board on a table with a flat and untwisted top. Pins can be pushed through all pieces in the kit without any lasting damage.

Don't be afraid to use plenty of pins when planking. The holes will fill up during sanding and doping. Use Sig-Bond glue for general construction except where the instructions call for epoxy. A single edge razor blade is best for cutting sticks. Use a modeling knife for cutting out sheet balsa parts.

Inspect The Wood

Though we try to eliminate spar wood with flaws, there is always the possibility of a too soft spar or one with an imperfection in a critical place. Double check the wing spar wood before building it into the wing. The most critical part of the wing is the center section and the first two rib bays on the outside of the cabin.

Use Enough Glue

The thousands of Kadet Senior and Senioritas flying are proof of the adequacy of lightweight structure when properly constructed. But the model will not be strong if you skimp on the glue. This is particularly true of the central area of the wing. The doublers must be glued to the spars with full glue coverage. The same thing applies to the plywood spar braces and to the wing spar webs.

A caution about cyanoacrylate glues. The thin glues are handy for instantly assembling a structure. However, unless the joints are perfectly fitted, they are able to fail later. Therefore I recommend that you go over all joints that have been assembled with a thin cyanoacrylate and make an external fillet of thick cyanoacrylate.

You Can't Get Along Without A Good Sanding Block

An indispensable tool for proper construction is a large sanding block, sized to take a full sheet of sandpaper. Use several wood screws along one edge to hold the sheet in place. Use the block to bring all parts and sticks to final, exact fit. I recommend 80 grit garnet paper for use on the block during general construction. You can switch to 100 grit, followed by 220 silicone paper for that finish just before covering. In addition to the large block, there are places where a smaller one is handy. Also a sandpaper "file" can be made by gluing sandpaper to a flat spruce stick for working in tight-places.

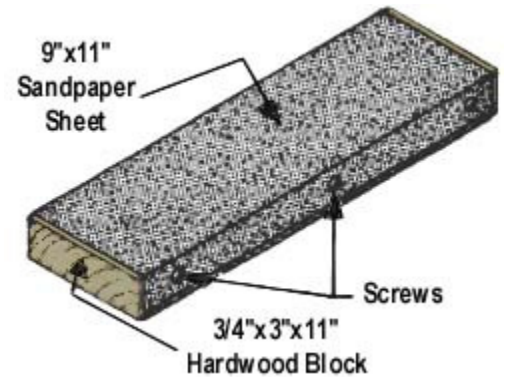

LEAVE THE COMPLETE BLACK LINE ON THE PRINTED PARTS! A modelling

knife or jig saw can be used for cutting out the printed parts. Don't cut too close to the lines - leave some extra wood outside the lines. True up and finish the edges with a sanding block as you are fitting the parts together or carving to shape. Don't force die cut parts from the sheet. Use a modeling knife to finish freeing them.

COMPLETE KIT PARTS LIST

COMPLETE KIT PARTS LIST			
Printed Balsa Sheets			
1 Sheet No.1 Fuselage Parts FN, G-1, G-2, FD	1 Sheet No.2 Cowl Parts C-1, C-2	1 Sheet No.3 WT, C-3	
Die-Cut Balsa Sheets			
2 Sheet No. 4 Ribs W-1	3 Sheet No. 5 Ribs W-2	6 Sheet No. 6 Ribs W-3	1 Sheet No. 7 Ribs W-4
1 Sheet No. 8 Elevator & Rudder Ribs			
Hardwoods			
2 3/16" dia.x5-1/4" Wing Dowels	1 3/8"x3/4"x3-3/8" Grooved Landing Gear Block	2 5/16"x5/8"x3/4" Anchor Blocks	1 3/8"x3/8"x7-1/2" Servo Mounts
1 5/32"x1-1/8"x1-5/16" Landing Gear Wedge	1 5/32"x3/8"x1-3/4" Birch Ply Right Thrust Shim		
Stick Balsa			
2 3/8"x3/8"x29" (or 36") Wing Leading Edge	5 3/16"x3/8"x36" Front Wing Spars, Top Spar Doubler, Fuse Crosspieces	4 3/16"x1/4"x29" (or 36") Rear Wing Spars	2 5/16"x5/16"x36" Stabilizer Frame
2 3/16"x5/16"x36" Elevator L.E. Diagonal Stab Bracing	1 3/16"x5/16"x18" Diagonal Stab Bracing	1 5/16"x3/4"x7" Stabilizer Center (36" cut into 7 pieces)	8 3/16"x3/16"x36" Fuselage Framework
3 1/4"x1/4"x36" Pushrods, Fin Frame, Rudder L.E.	1 1/8"x3/16"x24" Fuselage Rear Diagonal Braces	1 3/32"x1/4"x18" Fin Diagonal Braces	2 1/8"x1/4"x38" Fin Ribs, Rear Wing Spar Doublers
1 3/4"x4" Triangular Stock Wing Center Fillet	1 1/2"x12" Triangular Stock Firewall Braces	1 3/8"x9" Triangular Stock Wing Center Fillet	1 1/4"x1"x3-1/2" Fin Fillet RD (36" cut into 10 pieces)
Special Shaped Balsa			
1 1/8"x5/8"x24" Elevator TE, Notched	1 3/8"x1-1/8"x30" Left Wing TE Notched	1 3/8"x1-1/8"x30" Right Wing TE Notched	1 1/8"x5/8"x9" Rudder TE (same as elevator, but unnotched)
Spruce Sticks			
4 3/16"x3/16"x36" Fuselage Frame Corners	2 3/16"x3/16"x12-1/8" Cabin Top Pieces	5 3/32"x3/16"x7" Fuselage Nose Stringers	1 1/8"x5/16"x3" Stabilizer Brace
2 3/16"x3/8"x13" Bottom Wing Spar Doubler			
Sheet Balsa			
1 1/16"x3-13/16"x36" Fuselage Side Sheets	2 1/16"x3"x36" Fuselage Bottom Sheeting, Wing Tip Sheeting, Top of Nose	1 1/16"x2-5/8"x36" Wing Spar Webs (3" wide may be supplied)	1 3/32"x3"x24" Fuselage Top at Fin, Wing Center Section Sheeting
Die-Cut PlyWood			
1 1/8"x3"x9" Lite-Ply FT & FF	1 1/64"x5-3/4"x9" Birch Cabin Window Frames	1 5/32"x4-1/2"x15-1/2" Dihedral Doublers D-1, Firewall PF	
Wire Parts			
1 1/16"x9" Pushrod Ends	1 1/8" dia. Formed Nose Gear	2 1/8" dia. Formed Main Gear	
Hardware			
1 1/8" Nylon Nose Gear Bearing	1 1/8" Nylon Steering Arm	1 6-32x1/4" Screw for Steering Arm	7 Easy Hinges
2 Medium Nylon Control Horns	8 4-40 Blind Nuts for Nose Gear Bearing & Engine Mounts	8 4-40x3/4" Screws for Nose Gear Bearing & Engine Mounts	2 2-56 Nylon RC Links
2 2-56x10" Threaded Rods	4 No.2 2x3/8" Sheet Metal Screws for Main Gear	2 Small Aluminum Engine Mounts	2 Small Nylon L.G. Straps
1 Pushrod Connector Assembly			

Miscellaneous			
1	38"x50" Full-Size Plan	1	25"x38" Full Size Plan
1	28 Page Instruction Book	1	Kadet Seniorita Decal - 2 color
2	.015x2-5/8"x8-1/2" Clear Butyrate Cabin Windows	1	.015x4-1/4"x8-1/2" Clear Butyrate - Windshield
1	1"x12-1/2" Roll Fibreglass Tape		

Clevises supplied with the kit may be metal or plastic. If the pins fit too tightly in the nylon horns, open up the hole with a No. 51 drill.

WING CONSTRUCTION

1. Using several ribs as guages, pin down a 3/16"x3/8"x29" front bottom spar and rear 3/16"x1/4"x29" rear bottom spar on the plan.
2.
 - a. Pin down the notched wing trailing edge
3.
 - a. Glue a piece of 3/16"x3/8"x13" SPRUCE on top of the front spar as doubler.
 - b. Glue a piece of 1/8"x1/4"x13" balsa on top of the rear spar as doubler.
 - c. Begin gluing ribs in place, starting with the second W-1 rib. Do not glue the center W-1 in place until later.



ABOUT TRAILING EDGE RIB NOTCHES

The rib notches may vary slightly in position on the plan because, as noted, the plan paper is subject to shrinking or stretching with humidity changes. Therefore the rib may not sit perfectly on the rib position on the drawing. Ignor this and simply make the rib parallel to the rib drawing. The notches also tend to vary in depth and width. Take a die cut rib, draw a line on it 1/8" from the end and use this as a guage to check the notch depth and fit to the rib. Enlarge any notches that aren't deep enough or wide enough with a razor blade.

4. Continue pinning and gluing ribs in place on the spars, working toward the tip.
5.
 - a. Prepare the 3/16"x3/8"x29" top from spar by pre-gluing a 3/16"x3/8"x13" balsa doubler in place. Then glue the spar into the rib notches
 - b. Glue a 3/16"x1/4"x29" top rear spar in place in the rib notches. The top rear spar has no doublers.

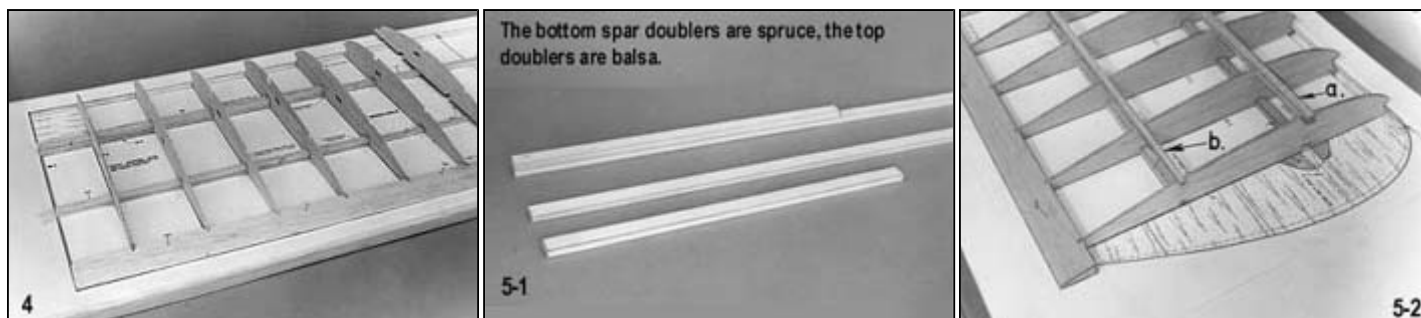

6.
 - a. Glue the 3/8" sq. x 29" leading edge into the front of the ribs.
7. Position the center W-1 rib, using the dihedral guage as shown, to get it at the right angle. Tack glue only until paragraph 18.

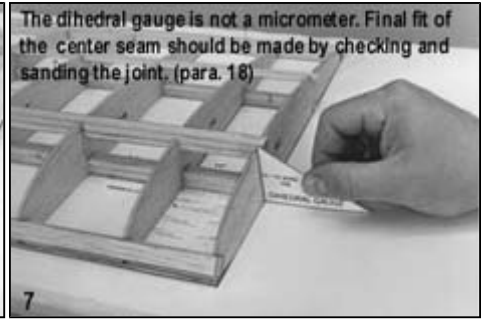
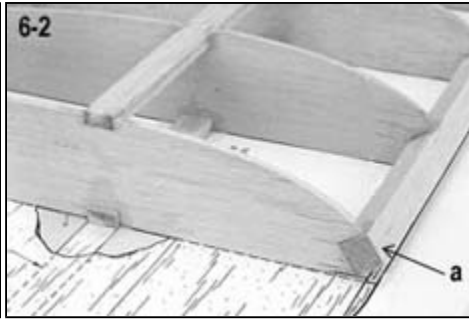
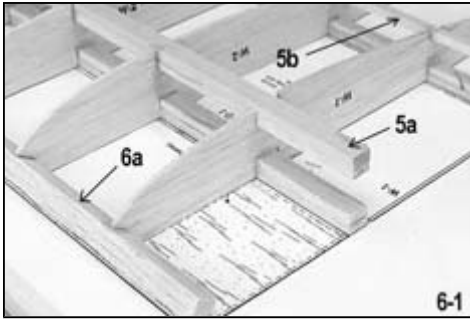

8. Glue the spar webs which are pieces cut from a 1/16"x2-5/8" sheet. Note that the grain is vertical.
9. Saw off the spar ends flush with the angled rib.
10.
 - a. Using the wing tip guage, glue the pre-beveled wing tip WT in place.
 - b. Add the stub spar, a piece of 3/16"x3/8" spar stock. Note the wing tip cross-section on the plan, which shows this piece to be recessed down from the top of the main spar so that the 1/16" sheet tip sheeting can be glued on over the stub spar.

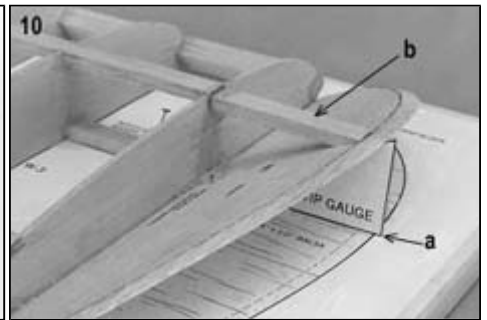
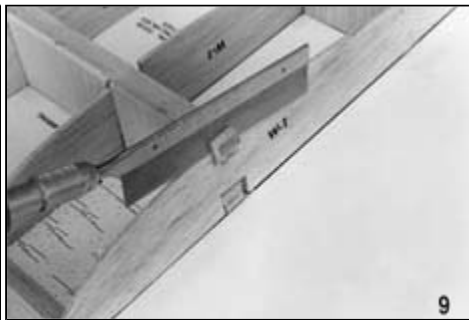

11.
 - a. Notch the main spar out 1/16" deep above the rib so the 1/16" tip sheeting will be flush with the top of the main spar.

12. Cut a piece of scrap wood to fit into the "V" formed by the wing tip WT. The front of the scrap is flush with the top peak of the 3/8" sq. leading edge.

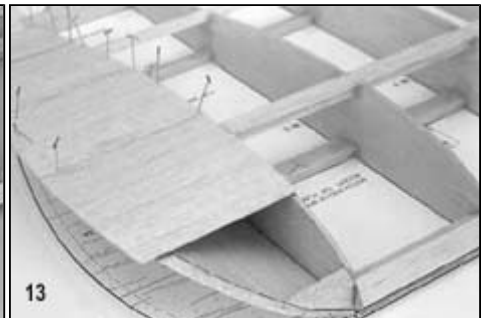
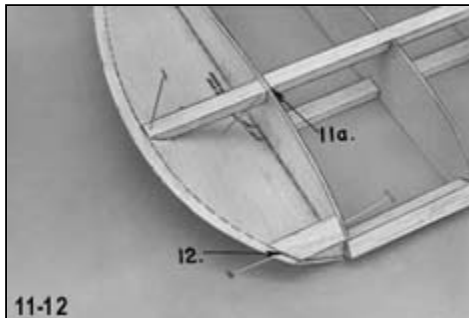

13. Sheet the wing tip with 1/16"x3" balsa pieces. Allow them to protrude past WT to provide room for trimming as seen below in 15.

14. Finish the front WT with another piece of scrap balsa.

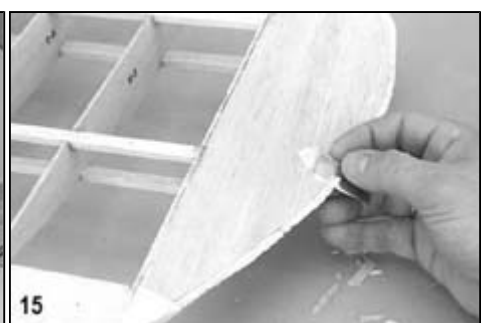
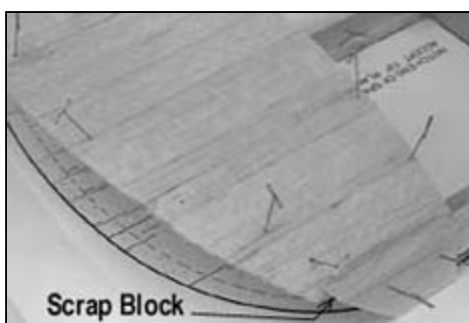

15. Turn the wing over and trim the top 1/16" tip sheeting off flush with the bottom of WT.

16. Trim the trailing edge block off as shown and sand and smooth.

17. Trim the leading edge block off as shown and sand and smooth. This shape is determined by the trimming and rounding of the leading edge. Do not shape the leading edge at the center section until after the windshield fillet is glued on later.

Repeat the previous steps in building the second half of the wing.

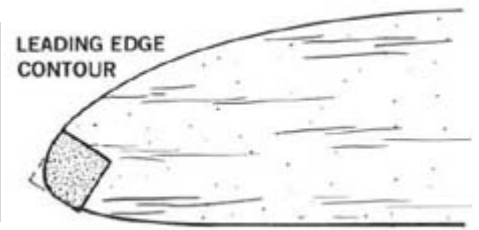
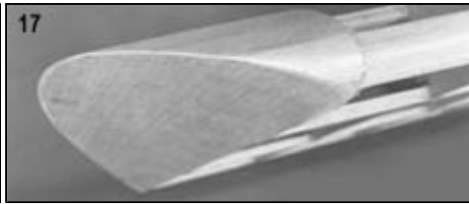

18. With one half of the wing flat on the table, raise the other half 3-3/4", measured at the bottom of the tip rib. The picture shows an easy way to do this with two measured scrap pieces of wood tack glued to the tip. This allows easy moving of the wing as you fine sand the root ribs as may be necessary to make them fit snugly together. Take a little time to get the fit right. We strongly advise drilling some 1/16" holes at slight angles about 1/4" to 3/8" deep, into the spar, leading edge and trailing edge faces.

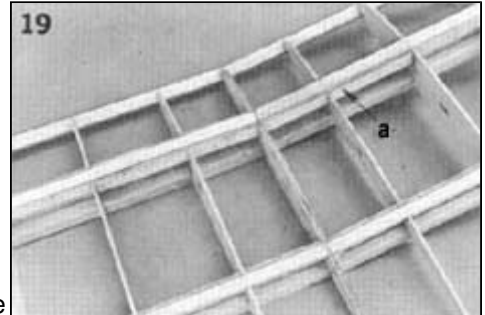
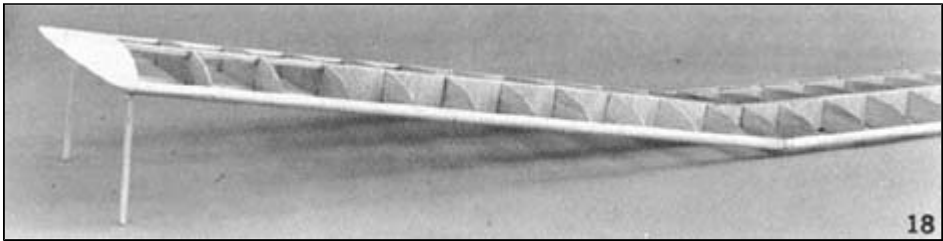

Use slow setting epoxy and work these holes full of glue with a wire. Then coat the faces of the spars. I.e. trailing edge and rib roots, and join the wing halves together. The holes full of epoxy will "nail" the spars together. If the wing ever breaks it will not be on the center line.

19. a. As soon as the wing is joined together, add the top 5/32" plywood spar doubler D-1

20. When the glue has set up, turn wing over and sand the bottom 5/32" spar doubler D-1.

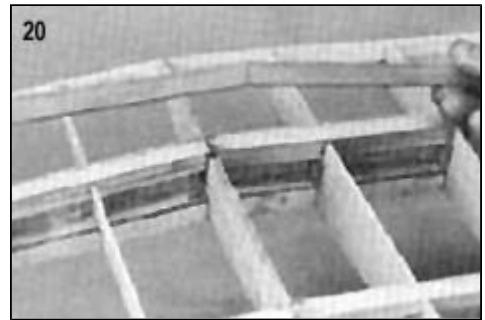

21. Sheet the center section with 3/32" sheet balsa.

22. For this step you will need the fuselage completed up to the point of having installed FF.

- a. Lay a piece of wax paper on top of FF. Set the wing on the fuselage and pin or tape it in place. You may need to sand the point of the dihedral joint at the leading edge slightly to get the wing to sit solidly on the fuselage.
- b. Sit the 3/4"x 4" triangular windshield fillet block on FF and glue it to the point of the unshaped leading edge.
- c. Fit two pieces 3/8" triangular stock between the windshield fillet block and the leading edge. Sand the face of them as required to fit snugly onto the wing as shown.

23. Turn the wing over and fit two more pieces of 3/8" triangular stock to the bottom in the same manner as the top. Trim off the bottom triangular stock flush with the bottom surface of the windshield fillet.

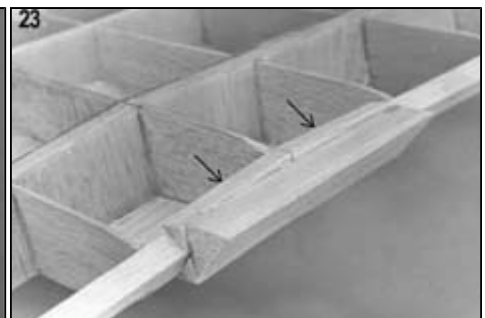
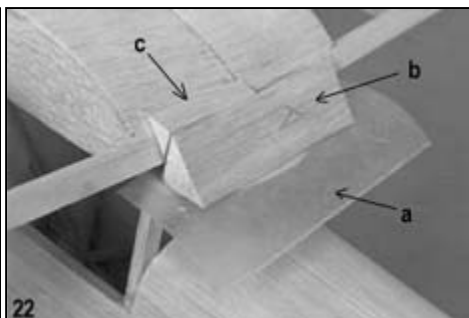
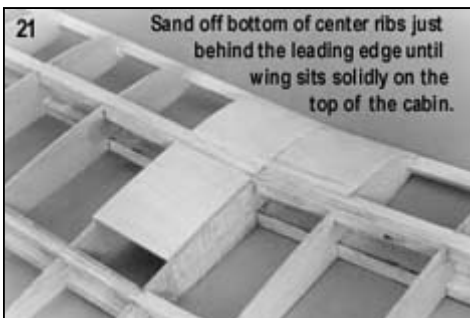

24.
 - a. Glue the paper windshield pattern to light card stock (like a manilla file folder) and position it on the fuselage. Trim as necessary for a perfect fit. Tape it in place.
 - b. Carve the top of the windshield fillet block roughly to shape with a whittling knife, removing it from the fuselage top to do so.
 - c. Replace the wing on the fuselage and get the final shape with a small sanding block, bending the fillet contour into the windshield angle.

24/3 The wing center joint is reinforced with the strip of 1" wide fiberglass tape. I use regular Sig Epoxy Glue (not Kwik-Set Glue) for applying the fiberglass tape, since it is thinner and easier to spread out smoothly. It will be even easier to spread if you warm the mixing container by setting it in hot water for a few minutes to raise the temperature of the glue. But work quickly, for the glue will set up much faster than normally when warmed.

- a. Coat the wing center with glue.
- b. Lay the tape on top of the glue.
- c. Holding one end of the tape so it won't slip, "squeegee" the glue through the tape, with a small paddle made from a scrap of balsa. Scrap over the tape several times with the squeegee paddle to smooth the tape and remove excess glue.

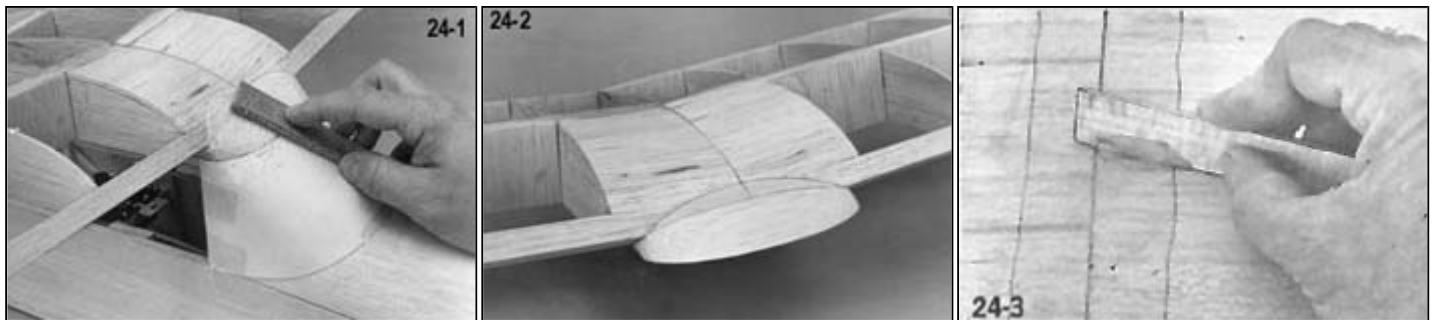

FIREWALL ASSEMBLY

READ THIS SECTION CAREFULLY

In designing a kit, we have to think about the buyers who have never previously built any type of model. For them, extra complications must be absolutely necessary or left off. Therefore, since the Seniorita will fly quite reasonably and safely without any right thrust offset in the engine, we show it with zero side thrust on the plan. (The downthrust in the engine is built-in, automatically incorporated without needing any extra effort or thought by the builder.) The pictures immediately following (26, 27, 28 and 29) will cover the engine installation as shown on the plan. After that we will show you an optional installation that will provide right thrust offset. Read this entire section. If you feel you understand the operational installation, use it to follow the directions in that section. Otherwise, skip that part.

Photos 26, 27, 28 and 29 also show the hole necessary for installation of a Sullivan RST tank, should you be using one. It will be placed as shown, in either the zero side thrust or right thrust installation. Look ahead in the instructions for more information on tank mounting.

25. Mark the horizontal thrust locating line and vertical centerline on the front of the firewall. (And the tank hole center, if used.)
26. Place the motor you will use on the firewall and draw lines as a guide for positioning the glass-filled mounts. (Different engines have different mounting dimensions.)
27.
 - a. Put a mark on the sides of the mounts so that the tops can be located on the horizontal thrust locating line.
 - b. Mark and drill out holes to pass the 4-40 mounting bolts.

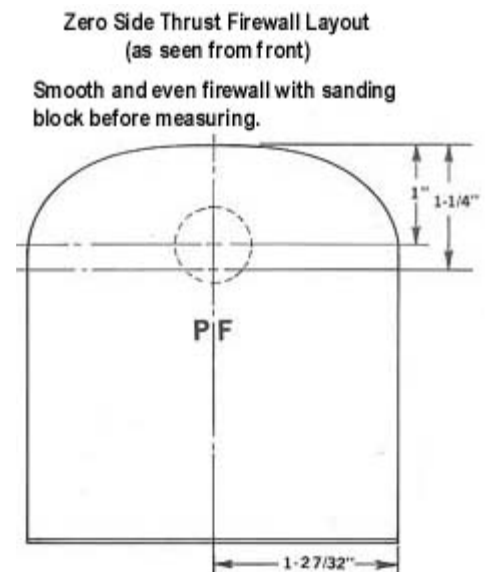

- 28.
- Glue the hardwood wedge to the firewall as a nose gear bracket mount.
 - Position the bracket, mark and drill the holes for the 4-40 mounting bolts.
 - Look ahead to picture 33 and you will see the 1/8"x1/2"x1-7/8" Lite Ply doubler strips on the back of the firewall as a base for the 4-40 blind nuts. These strips are cut from scrap ply off the 1/8" Lite Ply die cut wood. The strips are offset in picture 33 but if you are not using right thrust they will be centered. Be sure and epoxy the blind nuts to the back of the doubler strips and the firewall so they will not come out later when it may be necessary to take off the mounts. Don't get epoxy into the threads of the bolts. Pull the blind nut points tight into the wood with the bolts before the glue sets up. With the mounts and nose gear bracket in place, cut off the mounting bolts for both flush with the face of the blind nuts on the back of the firewall. This is to prevent any chance of the bolt ends puncturing the tank or rubbing on the batteries.

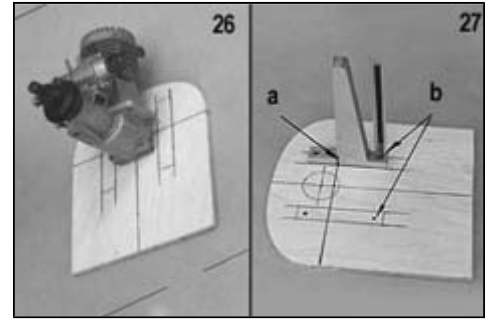

- 29.
- Bolt the spinner backplate to the motor. (This must be done to allow for the differences in spinners. For example, the Goldberg spinner has a recessed backplate which requires the motor to be farther forward than a spinner without a recess.)
 - Position the engine on the mounts so the spinner backplate will be 3-5/16" from the face of the firewall. It is handy to tack the engine in position with some spots of 5 minute epoxy or thick cyanacrylate, brought up over the edge of the edge of the engine to grip it good. Or a strip of double-stick masking tape is a little quicker, to keep the engine from slipping out of position during the next step.

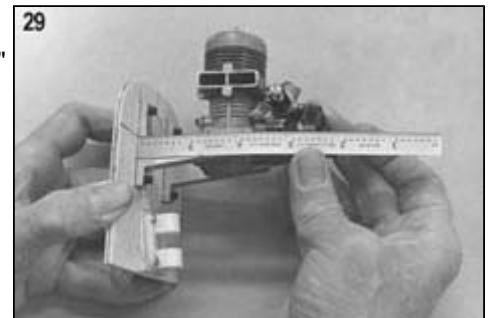
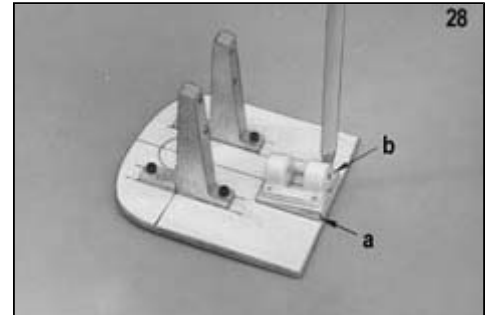

30. With a punch or sharpened piece of 1/8" wire, center punch the motor mounting holes. (Hint: If you are not used to doing this sort of job, don't try to punch and drill all 4 holes at once. Punch and drill only one hole. Then put the motor back on the mounts, secured by the first bolt. Punch and drill a 2nd hole, repeat the procedure, then the third hole, etc. With this process you are much less likely to make a drilling mistake that will ruin the mounts.) Drilling our mounts will not be a problem if a good quality highspeed drill bit is used, operated at neither too fast nor too slow a speed, lubricated and with moderate pressure.

OPTIONAL RIGHT THRUST

Adding right thrust helps the balance between high power and low power trim. If you decide to use it, follow the pictures from here on, keeping in mind the preceeding instructions as well.

Here's another and handy way to fit the mounts to your engine. It temporarily turns them into a one-piece mount.

a. Lay out guide lines on a piece of scrap 1/16" plywood of the proper width and height.

b. Mark the top of the mounts on the sides so that they can be accurately located.

c. Glue them in place on the scrap scab.

d. After completion, remove and discard the scrap block.

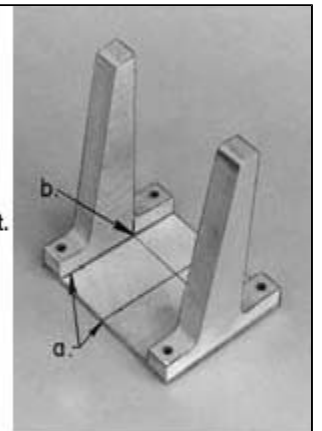

- 31.
- The landing gear wedge goes in the same place on the vertical centerline as on the preceeding zero side thrust installation.
 - A new vertical centerline for the engine mounts is drawn 3/16" to the right (as seen from the front of the firewall) of the firewall centerline.
 - A 3/32"x3/8" plywood shim (included in the kit) is glued on the position of the right (as seen from the front of the firewall) glass-filled mount.
 - The hole centerline for Sullivan RST tanks is halfway between the firewall centerline and the engine mount centerline.

32. The engine is then mounted in this offset position. Because of the angle provided by the shim on the one side, the prop is still approximately in the center (not critical) but it now has several degrees of right thrust offset.

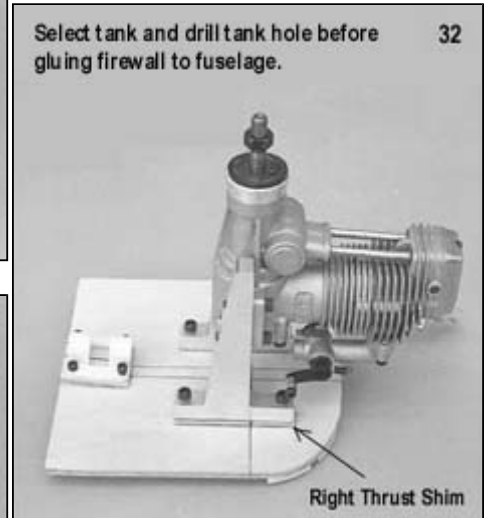
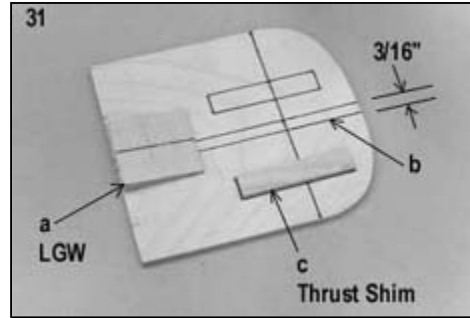

33. a. Because of the thrust offset it will be necessary to notch one side of the FT former that is glued to the back of the firewall to pass the 1/8"x1/2"x1-7/8" blind nut doublers strips.

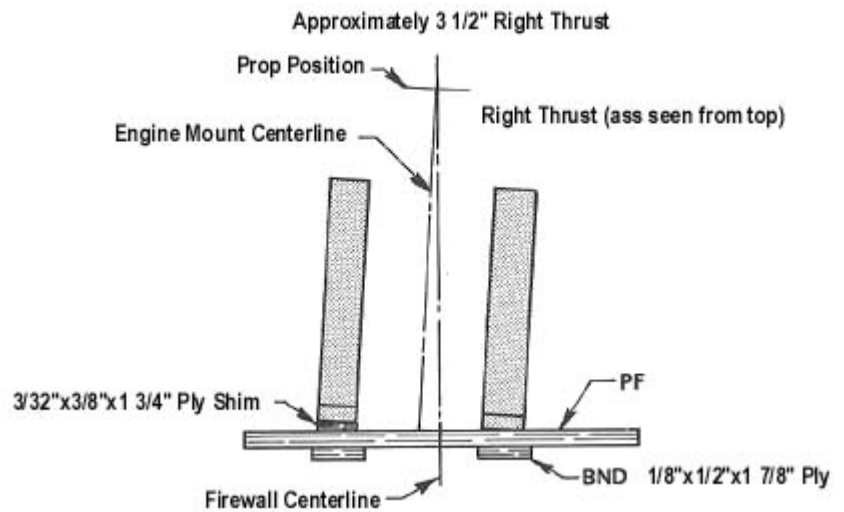
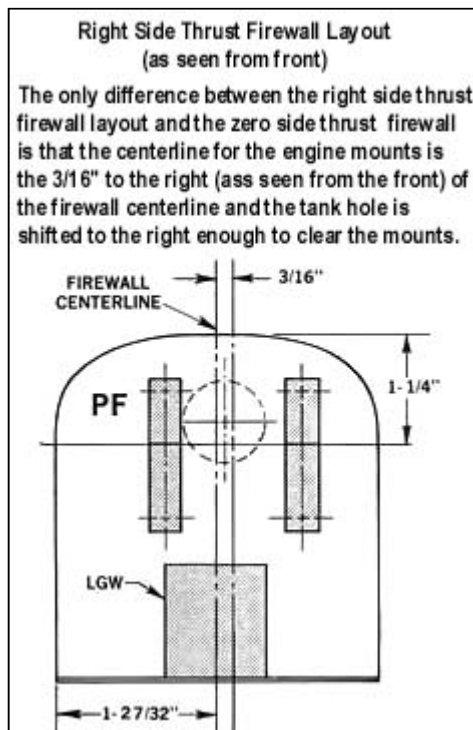
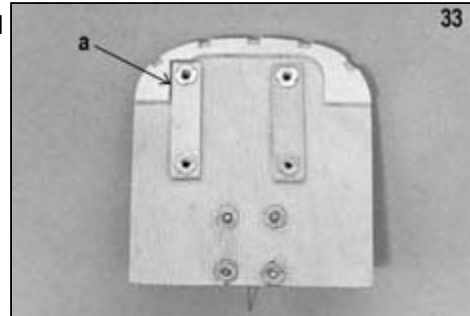

FUSELAGE CONSTRUCTION

34.
 - a. Soak the front end of the bottom 3/16" sq. fuselage stringer in water so that it may be more easily pinned into place on the plan in the curved part at the front.
 - b. Add the other lengthwise stringers of spruce and balsa.
 - c. Glue in FN.
 - d. Install the vertical 3/16" square balsa uprights.
 - e. Put in the 3/16" sq. diagonal braces.

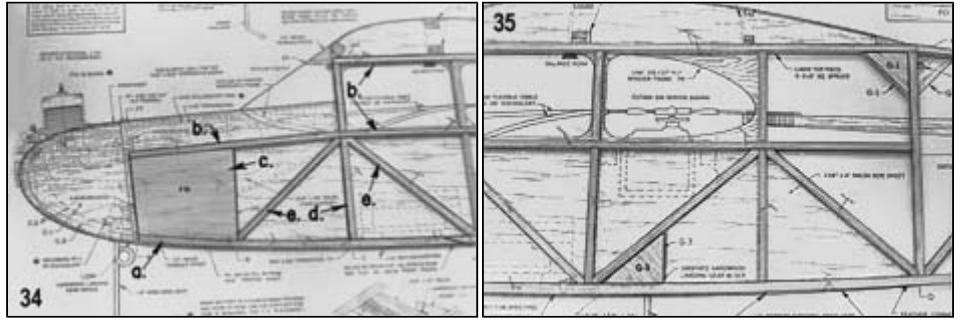

NOTE: The cabin top spruce pieces are precut. Do not cut up longer pieces of spruce for the cabin top. Make certain you understand the location of the spruce pieces in the fuselage before beginning to build it by studying the plan.

The spruce is indicated by call-outs and by a different wood grain than the balsa. Note the splice call-out located just above the "Landing Gear Detail" isometric drawing, which indicates the point at which the balsa front piece ends and the spruce rear section begins.

35. Glue G-1 and G-3 into the side (Leave G-2 until later).

36. Continue on down the fuselage with vertical and diagonal 3/16" squares.

37.
 - a. Trim a piece of 3/16" sq. to fit here.
 - b. In the rear of the fuselage the diagonal braces are 1/8"x3/16" balsa strip.

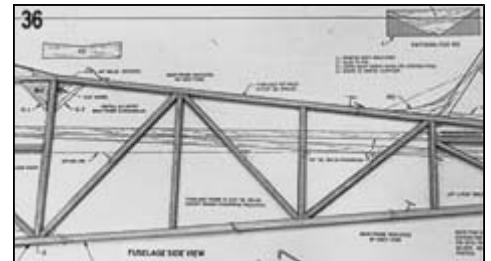

Build the second fuselage side directly on top of the first side, using pieces of wax paper at each joint to keep from gluing the sides together. Remove the sides from the board and mark a left and right side so as to insure the next step is done correctly.

38.
 - a. Glue a strip of 3/16" sq. spruce to the INSIDE of each fuselage side at section "D", just behind G-1 as shown.
39.
 - a. Glue a strip of 3/16" sq. spruce to the INSIDE of each fuselage side at section "C".

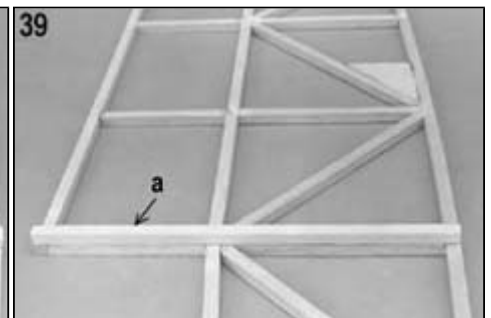
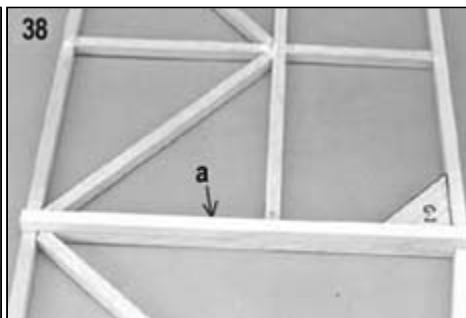
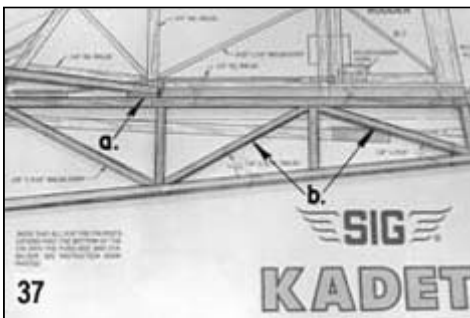

40. Using a straightedge to insure accurate alignment, join the two parts of the Fuselage Top View plan. Turn the fuselage sides upside down on the cabin top and pin them to the plan in the cabin area. Make certain that they are supported exactly perpendicular. Here we show temporary braces tack glued to the fuselage sides and to the board.

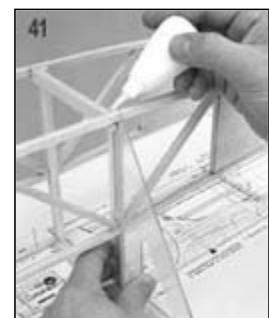
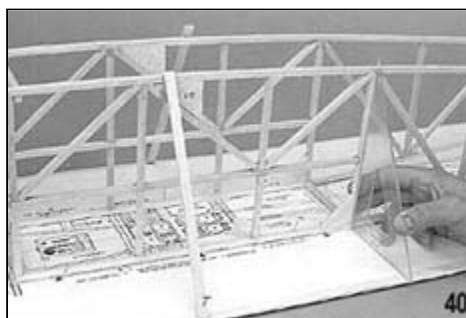

41. Keeping check on the alignment, add FC

42. A 3/16"x3/8" crosspiece on edge is used at section-D on the bottom.

43. Glue in the bottom 3/16" sq. crosspieces.

- 44.
- Use two flat sided weights to pull in the fuselage sides at the tail end.
 - Check with a 90deg triangle to insure they are directly over the plan.

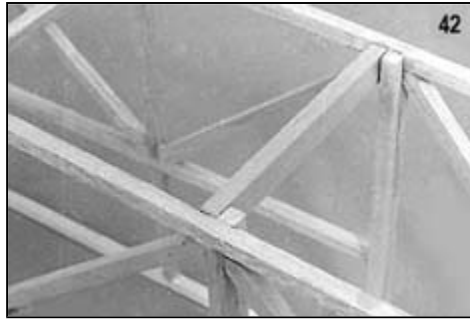

45. Add the other rear cross pieces

46. Complete the 3/16" sq. fuselage cross pieces between the cabin and rear end. (Look ahead to see the extra top crosspieces in the area of the fin. They can be put in later, after the sides are removed from the board).

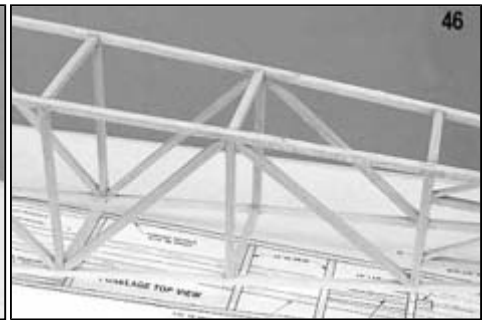

47. This picture shows the front crosspieces in the nose section after the fuselage has been removed from the plan, but it is best to actually install them before the assembly has been unpinned and removed.

48. Closeup of the fuselage top Section "D" - "a" is a 3/16"x3/8" piece on edge and "b" is a 3/16"x3/8" piece installed flat, behind the first piece. Glue "FD" in place.

49. Shows the top section "D" as seen from the bottom. The 3/16" diameter rear dowel is fitted in now, but do not glue it in until later so it will not be in the way of the fuselage covering.

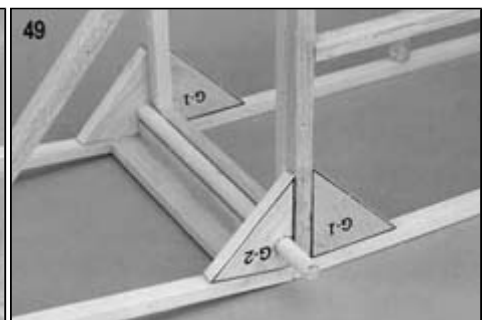
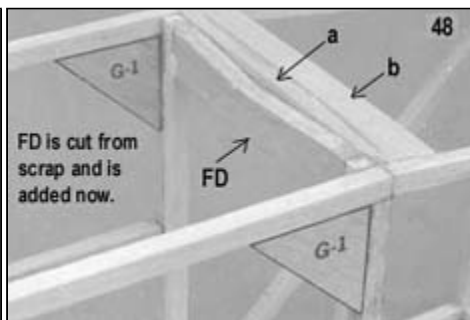
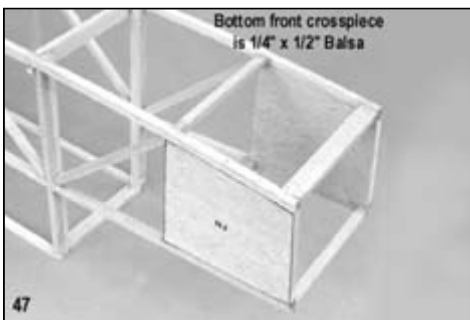

- 50.
- Mark and glue the grooved landing gear block in place on the fuselage bottom.
 - 3/16"x3/8" crosspieces on each side of the block installed flat.

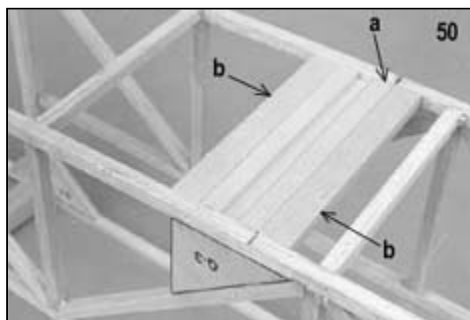

51. Begin sheeting the fuselage bottom with 1/16"x3" balsa with the grain running across the fuselage. Save the 3-13/16" wide sheet for the sides.

52. a. Complete the sheeting, leaving a gap for the landing gear groove.
 b. Glue strips of scrap 1/16" sheet balsa to the bottom of the stringers as shown.

53. a. Feather the scrap strips into the lines of the depth of the bottom, leaving them full depth where they touch the front sheeting, tapering to nothing at the back. (See fuselage side view.)
 b. Glue in the 3/16" sq. stringer doublers.

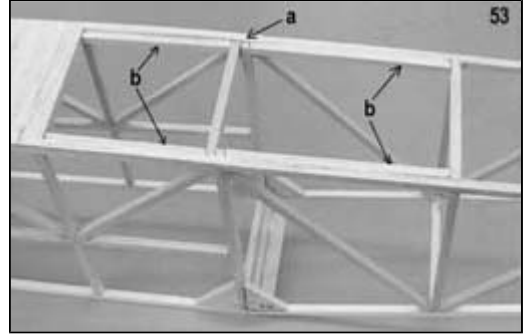
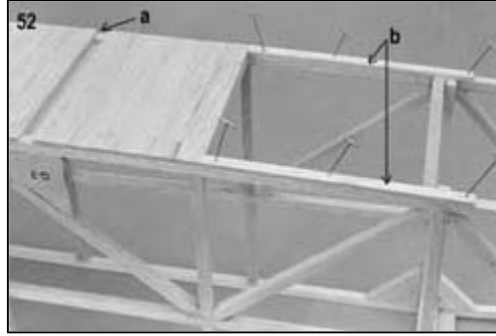

54. a. Glue the hardwood anchor blocks on top of the grooved landing gear blocks and to the insides of the G-3s

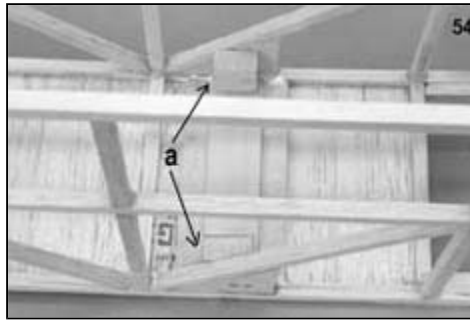

55. a. Add the extra 3/16" sqs. on top.
 b. Fill in the rear section with 3/32" sheet.
 c. Draw a centerline on the top of the fuselage.
 d. Cut Holes to take the fin stubs.

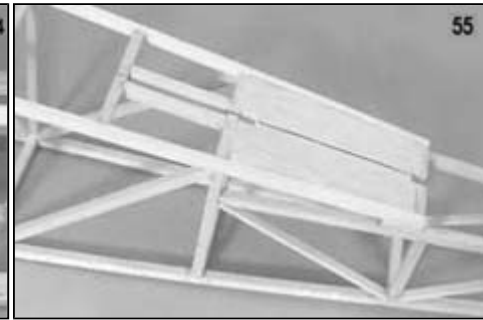

56. Shows the fin in place. Do not glue it on permanently until after the fuselage and fin are covered. At that time remove a strip of covering under the fin so that there will be a wood-to-wood gluing surface. The same rule applies to the portions of the stabilizer that are glued to the fuselage in the final assembly. Use a generous amount of epoxy to glue stab the leading edge and the trailing edge to the fuselage frame.

57. a. Cover the firewall blind nuts with tape to keep glue or fuel proofing out of them and epoxy the firewall to the front of the fuselage.
 b. Epoxy 1/2" triangular stock in the corners.
 c. Glue one of the FT ply formers to the back of the firewall.

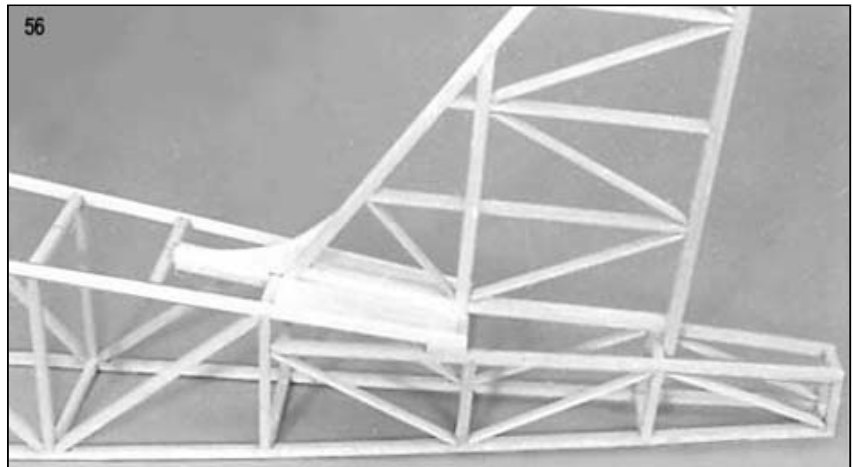

58. Glue a 1/16"x3-13/16" fuselage side sheet in place on the fuselage. The two sides are cut from the single 36" sheet of 1/16"x3-13/16".

59. Trim the side sheet to fit.

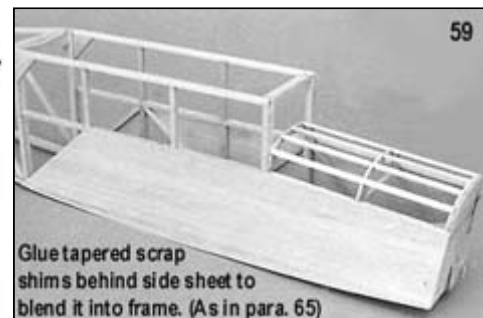
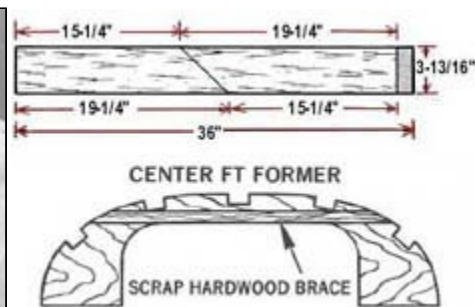
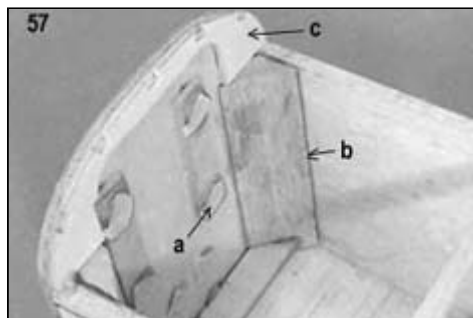

NOTE: The top of FT must be thin for proper tank position. The front FT is supported by the firewall. The rear one by the 3/16" sq. crosspiece behind it. Brace the center FT with scrap hardwood so that it will withstand the pressure of applying the top sheeting.

60.
 - a. Add the second and third FT formers.
 - b. Glue 3/32"x3/16" spruce stringers into the former notches.

61. We occasionally receive suggestions from builders that a removable hatch be designed into a model for access to the gas tank. Our opinion is this is not the best method in most cases. The hatch opening makes the nose weaker and there is no good way to keep oil from leaking in around the hatch. A method of fastening has to be built into the fuselage to hold a hatch in place.

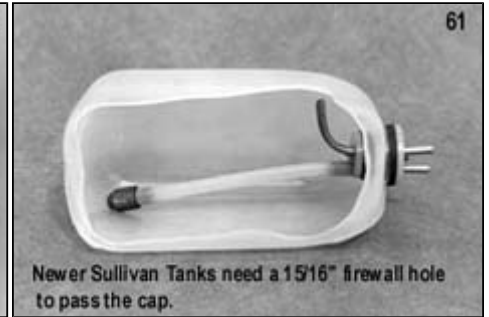
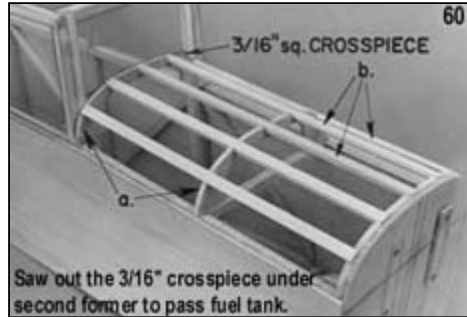

Modern plastic tanks are virtually indestructible under normal use and bursting or cracking is almost unknown. If you use Sig Heat Proof Silicone tubing (which will not harden or deteriorate in fuel) in the plastic tank, the tank will seldom have to be removed. We have models in which the tank has been installed for three or four years without ever needing removal. So it is quite practical to put the tank in semi-permanently. Check the models at a contest - you'll find that the majority have sealed noses, as does this kit.

We show a Sullivan RST tank on the plans. Other types of tanks, such as the DuBro, will require slightly different mounting and application but the principles discussed here are the same for all tanks.

The newer Sullivan type of tank requires a 15/16" diameter hole in the firewall through which the tank cap protrudes, as we show in the first part of the firewall section. So as to also cover the DuBro type of tank, the pictures of construction following this tank section will show one of these tanks installed in the fuselage. The main difference in the tanks is that the cap of the DuBro tank is meant to remain inside the fuselage, with only the fuel lines going through the firewall. The following comments apply to both types.

With most engines, the best installation will be with the tank as high in the fuselage as the cutouts in the FT formers will allow. Put scrap wood crosspieces under and at the back of the tank. Seal the firewall hole with G.E. Silicone Bathhtub Seal (available at hardware stores). Put an oil proof finish on the firewall and in the hole before sealing the tank cap or fuel lines with silicone. Gel some of the silicone sealer in the hole and over the edge at the front. Don't install the tank permanently until after the model is covered and painted. Should you need to remove the tank, break out the scrap wood cross piece in the rear and push out the silicone rubber seal around the front. Reach into the fuselage and guide the tank inside.

Some builders, after putting their receiver battery in a plastic sack, taping it shut, wrapping it in foam rubber package and stuffing it into the nose under the tank, then stuff paper toweling or foam rubber in to fill the nose compartment and keep everything firmly in place.

After installation, put fuel tubing on the vent tube and run it to the outside of the cowling on the bottom, so that fuel overflow is not blown over the wing-fuselage joint, where it may leak into the fuselage. The best way to fill the tank is to take off the fuel line to the needle valve and pump the fuel in there until it runs out the vent. Be sure and use a filter on your fuel supply can, and it is a good idea to have a filter between the tank and needle valve also.

PRESSURE FEED

If the engine you are using is equipped with a muffler pressure tap, make use of it for more even fuel feed and reliable operation. The hookup for pressure is shown in the picture. To fill the tank, remove fuel line from the needle valve on the engine and pump the fuel in. When the tank is full, it will overflow through the muffler pressure line. Use transparent or translucent fuel line so you can see the fuel starting to overflow when the tank is full. Should some fuel happen to get in the muffler, drain it out before starting the engine. Do not try to fill the tank in reverse from the pressure line, the tank will not fill properly and fuel may be forced into the engine.



62. Shows a DuBro tank installed in the fuselage. Also see the next picture. Two lines are enough unless you have a fuel fitting on the carburetor that is not accessible. In this case, use a 3rd line as a fill tube. You can also use individual holes for each line.

63. Cover the top of the fuselage nose with pieces of 1/16"x3" sheet. If the grain does not allow bending it into position dry, and it likely will not in many cases, dampen the top of the sheet with water and allow it to soak in before curving it into place on the formers. It helps to have one edge glued on first, as shown here, rather than trying to put it on in one step. (We left the tank and lines in to show you more of them. Have them out when you are sheeting the top.)
64. On the plans we show the servos mounted high in the fuselage for easy access. Some think this spoils the appearance, since they stick up and show through the windows. So in this picture we have a 3-servos-abreast installation mounted a bit lower, below the cabin window line. Because Futaba doesn't make a 3-servo tray of this type, we used three single FST-28V trays. You can also see the flexible cable pushrods running from the throttle and nose wheel and glued to scrap standoffs. Silicone seal makes a good adhesive for fastening the outer tubing to the fuselage because it is slightly flexible and doesn't make a hard spot in the tubing.



Life is not simple in the model game when it comes to pushrod installation. Most servos are standardized as to which direction they move in response to a particular transmitter stick movement but there are exceptions. Regardless of the direction of movement of the servo, you can adapt to it by moving the pushrod to whichever side of the servo output arm or wheel will give the pushrod movement direction desired. Sometimes this requires that a pushrod brought down the side of the fuselage has to crossover to the inside of the servo output arm to get the desired direction of pushrod movement.

Some radio manufacturers make available reverse direction servos and often include one or more in an outfit for situations where the opposite direction of pushrod movement without changing servo sides is desired. For example, it is desirable to have the hookup for the pushrods to the nose on the outside of the servo so that the pushrod tubing need not be flexed as far as crossing over to the inside would require. At the same time the pushrods to the tail would be on the inside where there is plenty of room to maneuver it around. The current trend is for equipment to have a servo reversing switch built into the transmitter. If the servo doesn't run the direction you prefer, just flip the switch. Several companies make reversing converters that can be plugged into a servo cord to reverse the direction of movement of a standard servo. But if you do not have a reverse servo it is quite possible to get along without it.

WHICH SIDE FOR THE RUDDER PUSHROD?

The choice of which side of the fuselage the rudder pushrod will exit from is determined by the position of the throttle control arm on the engine to be used. If it is on the right (most common), use the servo nearest the right side of the fuselage for motor control. Use the servo nearest the left side of the fuselage for the rudder, with the rudder pushrod coming out to the left side of the rudder and the nosewheel steering arm hooked up on the left side of the nose gear bearing. This setup would be the case with most glow-plug engines, as with the Fox shown on the plan.

The opposite is true of the O.S. .40 Four-stroke we are using in the picture sequence so as to cover this circumstance. On this engine the throttle arm is located on the left side, so the servo on the left side would be used for engine speed and the one on the right for rudder and nose wheel. This calls for the rudder horn to be located on the right side of the tail instead of on the left as the plan shows.

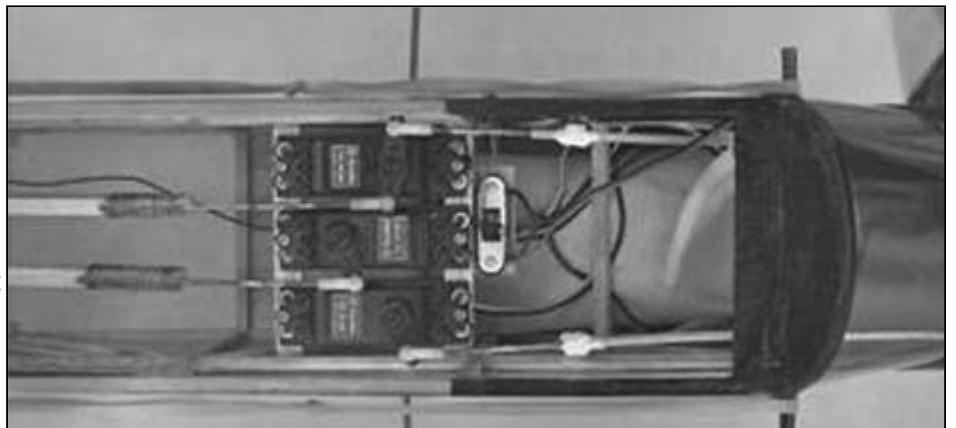

As you can see, it is best to know in advance the radio and motor brand you will be using before you install permanent cable pushrods. Decide on which type of fittings you will use in the case of the cable pushrods and have them on hand during construction because the type chosen will affect the location of the pushrod exit holes through the firewall, etc. The balsa pushrods to the rudder and elevator are not limited as to location and can be adapted to any of the types of connectors shown without preliminary planning.

SERVO HOOKER-UPPERS

Having the proper connector makes servo installation much easier. We show here a variety of ways to attach pushrods to servos.

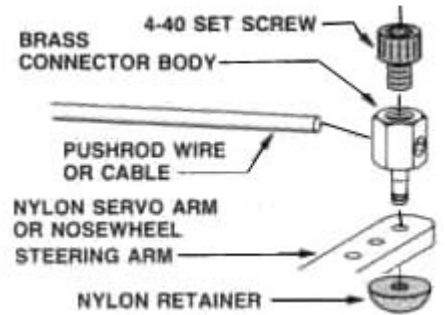
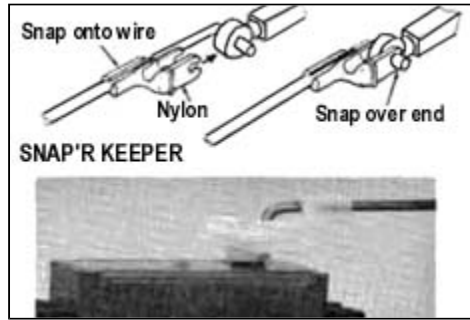

DuBro Ball Links, which come in several different types - threaded, bolt-on, rivet etc. - gets the pushrod action up above the control arm so the pushrod can approach from a variety of angles without any chance of interfering with the servo center post. It is good for cable pushrods. A line adjustment can be made by screwing the end in and out.

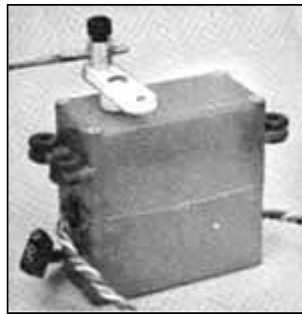

A typical Futaba plastic servo mount. Similar mounts in a variety of styles are available from most radio makers. FUTABA Type "V"

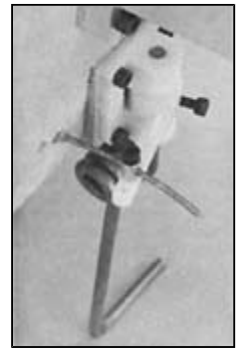

The Sig Pushrod Connector included in this kit can be used for attaching the nosewheel pushrod cable to the steering arm as shown. Additional pushrod connectors can be purchased (Sig No. SH-736) for use on the throttle and nosewheel servo arms. Adjust by loosening the set screw and sliding the cable.



Angle the nose gear steering arm forward in neutral to allow more range of movement.

PREPARING CABLE PUSHRODS

To keep ends of cable from unraveling during handling, tin the end with solder. Use a non-corrosive paste flux (shown here is Kester, available at hardware stores) and rosin core solder. Have a hot iron and flow the solder completely through the cable. Grind or file the end smooth. Bring it to a point so that it will easily insert into the pushrod fittings. After the proper length is arrived at, sweat solder the area to be cut so that it will not fray and unravel while being cut. It can be cut with a good pair of side-cutting pliers, filed in two, ground through on the edge of a grinding tool, or cut with a silicon cutting wheel on a motor tool.

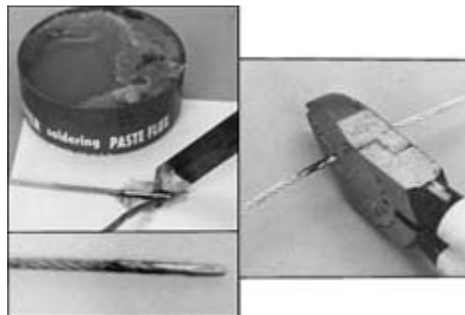

FOUR CYCLE THROTTLES

It is common for 4-cycle engines to have their throttle control arm on the back of the engines, unlike 2-cycle types which have front carburetors and plenty of room in front of the firewall for adjustable linkages and couplers. In the installation of the O.S. 4-stroke, we got around this problem by use of a DuBro 180 Bolt-On Link. The ball was bolted to the carburetor arm. Since there was no room for the threaded coupler, it was discarded and the nylon ball link socket was bound to the end of the throttle control cable with epoxy glue and fine copper wire. Thick cyanoacrylate would also work. The photo shows this installation.

65.
 - a. Pre-bevel the front edge of FF, using the pattern on the plan and glue it onto the front of the cabin.
 - b. Glue tapered scrap shims on each cabin window upright. The idea is for the cabin window frame to be flush with the fuselage sides at the bottom and glue directly to the top edge of the top spruce cabin stringer at the top. (See cross-section drawing here.) Shims are also a nice idea on the sides just behind the cabin window frame. It makes covering a neater job.
66. The clear cabin windows are glued to the inside of the die cut ply window frame. Make sure you do it left and right. The main necessity here is to avoid warping this thin assembly. Therefore do not use water base glues such as Sig Bond or Tite Bond. Do not use cements like Sig-Ment or Ambroid. The ideal adhesive appears to be slow-setting cyanoacrylate but precautions should be taken for this to come out right. First, make sure the ply frame will stay in place on the table by fastening it down with double-stick tape or a tack-glued corner or two. Then stick several pins along the bottom as guides. Have one at the corner to position the window material lengthwise as well (The pin seen on the far right). The critical step is next, getting the right amount of glue. About a 3/32" diameter bead, located 3/32" to 1/8" from the window frame edge is approximately correct. The idea is for the bead to spread almost to the edge, but not over it, when the clear plastic is pressed down. Too big a bead and it will squeeze out onto the window. Since glues are of different viscosity, I'd suggest a trial run on a bead size with scrap plastic from the windshield. Also, of course, put glue beads on the frame farther away from the window outline, such as in the back portion that is a long way from a window. So having practiced, apply the glue to the frame, sit the clear plastic on the pins as shown in this picture and hinge it down onto the glue.

If you don't have slow-set cyanoacrylate, the next best substitute is contact type glues, preferably sprayed on the ply.

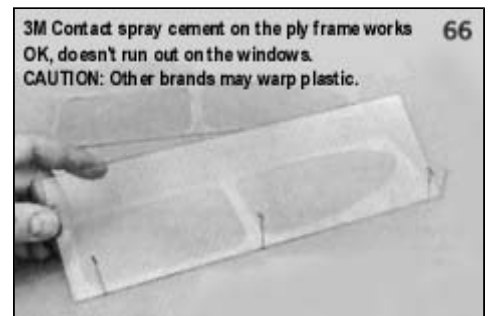
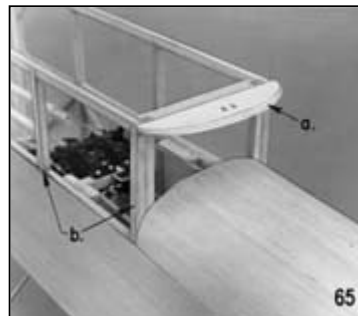
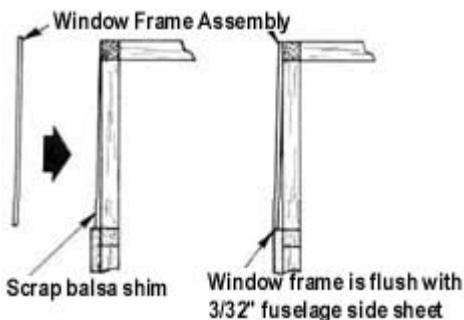

67. So that the clear window will not be damaged during handling and covering, protect them with masking tape. Use a sharp, new modeling knife to trim the tape against the edge of the ply frames. I covered right over the masked-off windows with silk, then doped the silk, finally trimming it off flush with the ply frame and removing the tape last. It is also a good idea to tape the inside of the windows. This doesn't need to follow the frame lines, just cover the whole clear window. Caution: Don't leave the tape on a long time, it dries out and sticks down tightly. Low tack drafting tape is best for the job but regular tape will work if you do not leave it on too long.

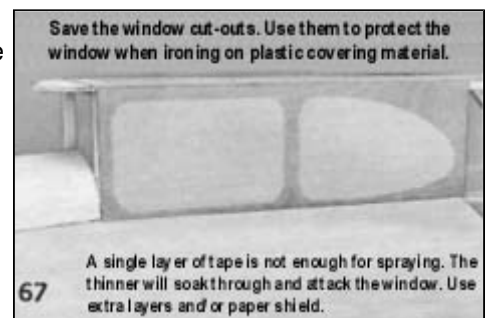

68. We have previously established the final windshield pattern shape. Now use the pattern to locate the position of the dowel holes in the windshield. Use plenty of epoxy glue to glue the dowel to the fuselage and to former FF. Make a fillet of epoxy over the dowel on the face of the vertical 3/16" sq. balsa and 3/16" sq. spruce. Do the same for the areas where the fuselage crosspieces attach to the fuselage sides. Cover and/or paint the model before gluing on the windshield. Use Wilhold RC-56 or cyanoacrylate glue to attach the windshield. It helps to glue down one side of the windshield to the fuselage first so you can pull against it to stretch the rest of it into position for gluing. Make certain, however, that the first side is properly lined up. Taping the rest in place helps.



69. Drill 1/8" holes into the anchor blocks for the torsion arms. Recess nylon straps into the 1/16" bottom sheeting.

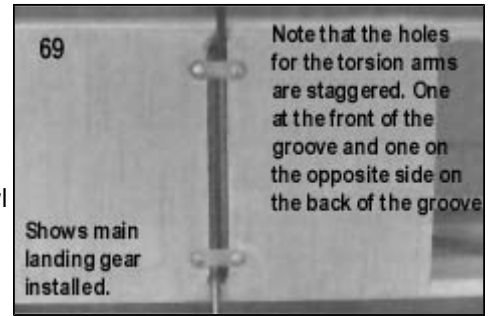

70. Cut out the cowl parts C-1 and C-2 and glue together as shown. Note that the bottoms are lined up flush and the backs are even. We have laid the C-3 parts in place here to show their general location but do not glue them in until later, after the cowl main shaping and sanding is completed. If you make use of a longer cowl for a specialized engine you will have to plot a new C-3 to match the modified shape. The cowl used on the plan will fit most engines. C-3 simply makes a notch so it is easier to glue the 3/32" bottom sheeting.

71. Glue the cowl halves to the fuselage, flush with the bottom and sides.

72. Carve the cowl sides to a pleasing shape. Add C-3 exactly 3/32" deep from the sanded bottom cowl shape.

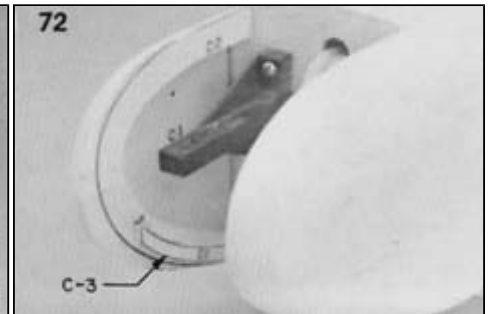
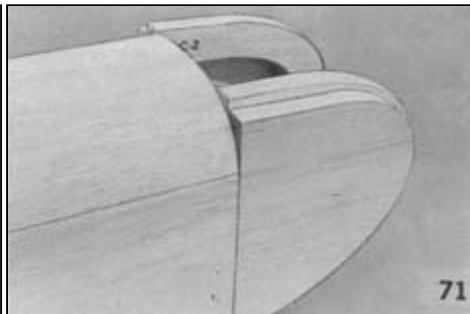

73. Cut away the inside of the cowl to clear space for pushrods or engine parts. It is a good idea to carve a taper into C-2 on the inside to make it easier to paint or fuel proof the cowl interior, but do not do this until later, after the front and any top fill-in blocks desired are added.

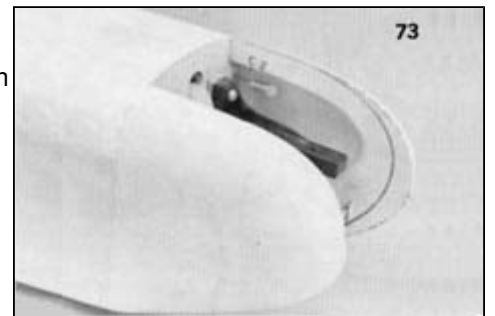

74. Put the spinner backplate on the engine and glue on pieces of 1/2" triangular stock as shown, using the spinner backplate as a guide for correct placement. Don't carve to final shape until top and bottom wood is in place.

75. Cover the bottom with 3/32" sheet balsa.

- 76.
- a. Cut a hole for access to the nose wheel steering arm adjustment screw.
 - b. Add scrap wood as desired to complete the cowl shape



77. We added some more scrap wood to the top to improve the appearance. This addition is determined by the engine used and/or your preference.

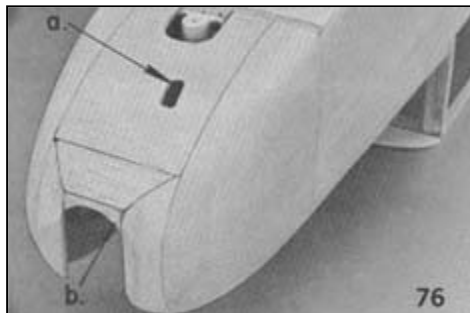

TAIL SURFACES

78. a. Pin down the pieces of 5/16" square for the outside frame of the stabilizer.
b. Make a corner gusset from scrap wood.

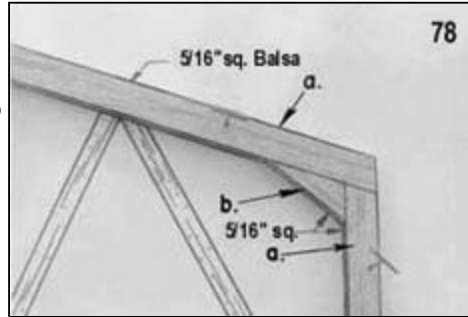

79. Cut center brace to fit.

80. Glue in place.

81. a. A 1/8"x5/16" hardwood brace is glued across the back.
b. Next add the 5/16"x3/4" strip center rib.

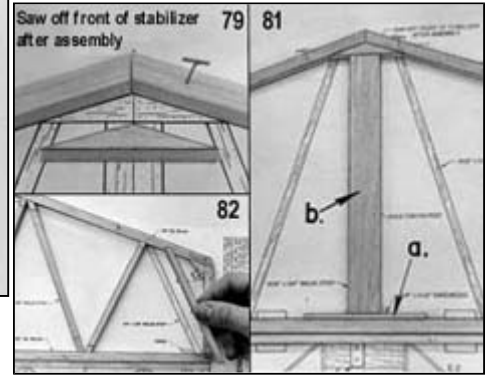

82. Cut and fit 3/16"x5/16" strips of balsa.

83. a. Pin down the 3/16"x5/16" elevator leading edge.
b. Pin down the notched trailing edge,
c. Glue E-1 elevator ribs between them.
d. Pre-taper 5/16" sq. ends.

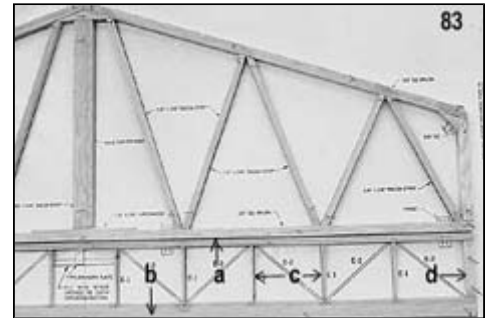

84. a. Add the diagonal elevator ribs.
b. Fill in the center with scrap.

85. a. Saw the front off and leave it square and unshaped.
b. Shape the leading edge to a rounded contour.
c. Do not shape the stabilizer trailing edge. Leave it square.

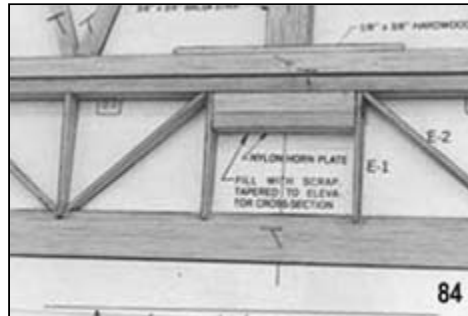

86. a. Pin and glue pieces of 1/4" sq. balsa to make the main frame of the fin.
b. Note the stubs, left on below the bottom fin line.

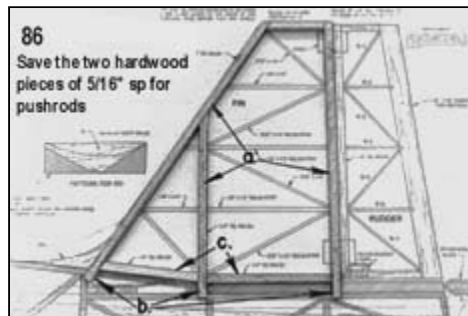

87. a. Add 1/8"x1/4" ribs.
b. Glue in 3/32x1/4" diagonal braces.

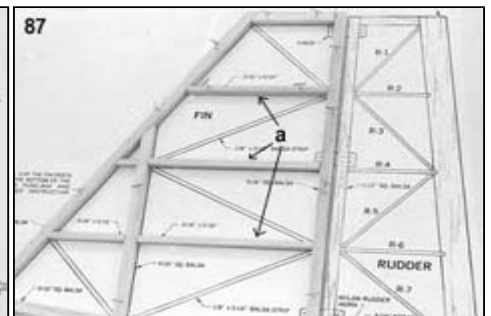

88. a. Pin down the 1/4" sq. rudder leading edge.
b. Pre-notch the shaped rudder trailing edge. (It is not practical to supply it notched accurately at an angle as required.) Pin down to the plan.
c. Glue R-2, R-4 and R-6 ribs between them.

RUDDER CONSTRUCTION BY CROSS-SECTION

(ELEVATOR IS DONE IN THE SAME MANNER)

- 1.) BUILD FLAT ON THE BOARD.
- 2.) SAND TOP WITH THE SANDING BLOCK.
- 3.) CHANGE ORIENTATION FROM FLAT TO CENTERLINE.
- 4.) TRIM OFF THE FRONT AT ABOUT A 25 TO 30 DEGREE ANGLE. BECAUSE OF THE CHANGE TO CENTERLINE ORIENTATION, SLIGHTLY MORE MUST BE TRIMMED OFF THE TOP HALF OF THE FRONT THAN THE BOTTOM HALF.

89. a. Add the diagonal ribs R-1, R-3 and R-5.
 b. The top and bottom of the rudder are pre-tapered pieces of 5/16" square. (Refer to small drawing 83. The rudder pieces are done the same way, tapering from 5/16" to 1/8").
90. a. Fill in some scrap as a control horn mounting place.

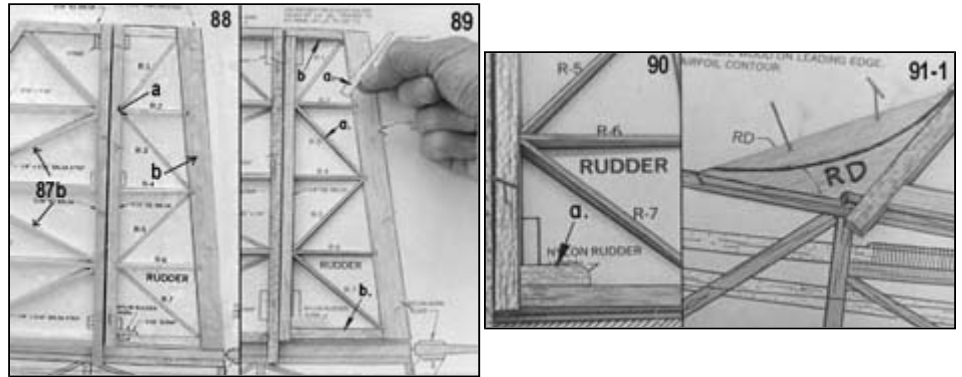

91. Glue RD in place on the fin leading edge and shape.

92. Carve the fin leading edge and tip to a rounded shape. (The elevator tip is similarly shaped.)

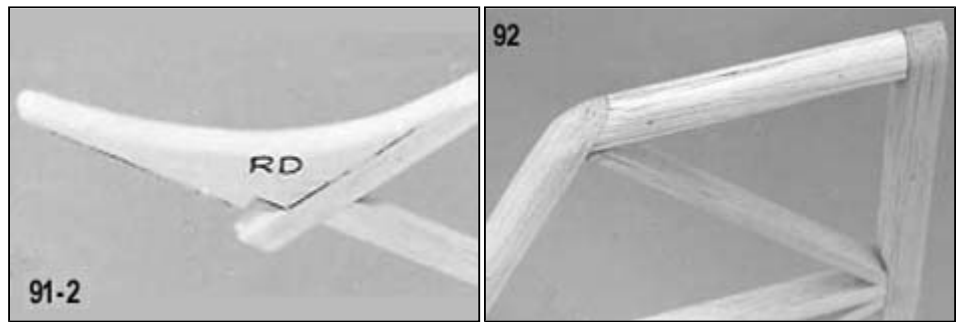

93. Fit the nylon control horn to the elevator now, but do not mount it permanently until after the elevator has been covered.

94. Fit the nylon control horn to the rudder now, but don't mount it permanently until after it is covered.

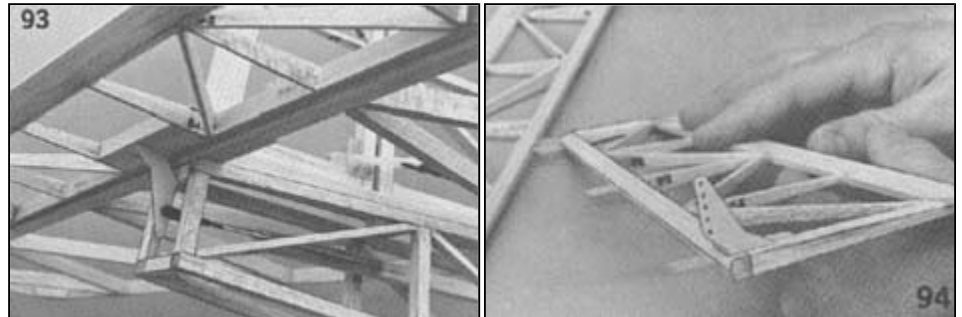

95. The prototype model shown on the box lid used Williams Brothers Smooth Contour wheels with the enclosed hubs because they looked nice. Use of them requires cutting off the axles and grinding down wheel collars so they will be inside the hub. If you do not wish to do this, use William brothers Balloon Style Wheels, which are similar but have regular hubs. Solder a washer on the nose gear as shown here so the wheel will not bind on the bend. Other sizes and types of wheels can be used but have the nose wheel diameter 1/2" smaller than the main wheels. (Unless deliberately altering the level attitude of the model for reasons described later in the "Ground Aiiitude" section.)

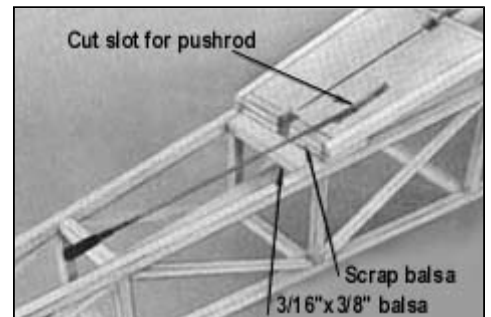
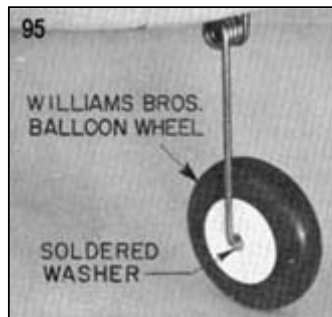

COVERING AND FINISHING

The prototype Kadet Seniorita was covered with Sig Light Weight colored silk. The black decorations were painted with Sig Supercoat Dope and the pinstriped with Siver Supercoat. The colored silk saves weight because it needs only clear dope for finishing.

The majority of RC trainers are covered with plastic film because of the simplicity of application. There is no better iron-on covering than Sig Supercoat. Check the Sig Catalog for more information and a listing of the wide range of available colors.

The manufacturer's directions for applying iron-on coverings are packed with the material. Follow these closely, for different types of covering have different iron temperatures and techniques of application.

Whatever kind of covering you desire to use, it will not conceal a rough framework. Sand carefully with fine sandpaper before beginning.

COVERING WITH SILK, SILKSPAN, OR SILRAY

Although we refer to silk in the directions, all of these coverings are applied wet in the same manner as follows. Brush an unthinned or very lightly thinned coat of clear Sig Supercoat or Sig Lite-Coat Dope over all parts of the framework that will contact the covering. When dry, resand with fine sandpaper to remove any fuzz or raised grain. Brush on a second coat and sand again.

The bottom of the wing is a good place to start covering. Cut a piece of material about 1/2" larger all around than half the wing, with the grain running lengthwise. (The grain of woven materials runs parallel to the finished bias edge.) Some builders next dip the piece in water and apply it to the wing. We find that the silk sticks together and takes a lot of pulling and smoothing to get it in place so we do it a bit differently, as shown in the photo.

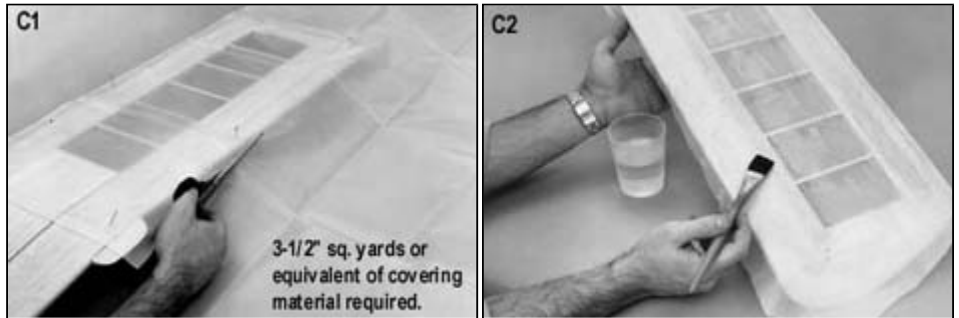

Pin the dry covering in place and "paint" the water on with a brush.

Go around the edges, pulling out wrinkles and stretching the material smooth. You need not pull it up drum tight, in fact going to this extreme is not advisable. Just pull out all of the wrinkles. Use pins, if necessary, to hold the silk smooth, though wet silk usually stays in place without too much pinning. We like to fasten one end pretty firmly with pins so that you can pull against this anchored end in stretching the silk the long way.

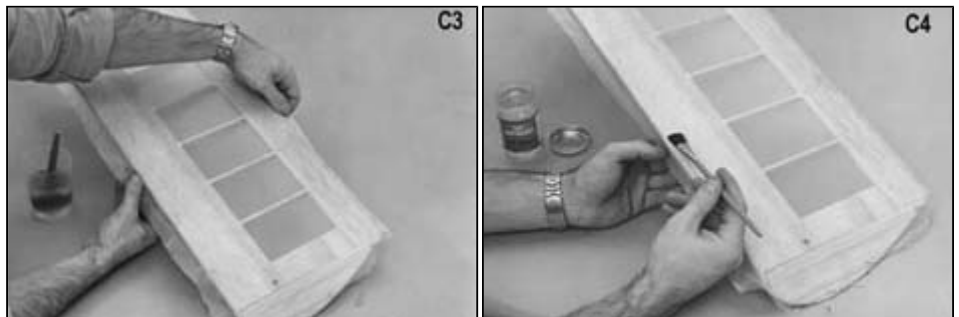

Brush around the outside edge of the stretched silk with clear dope. The dope will soak through the material and adhere to the dope already dried into the framework.

Trim off the edges with a sharp blade. We find a thin double-edged razor blade is ideal for this, but a single-edged blade does okay and you can't cut your fingers on it. On the bottom, trim off flush with the wing all the way around. Go over any rough area or places that have not stuck down properly with more dope and press the loose spots down as the dope is drying and getting stickier.

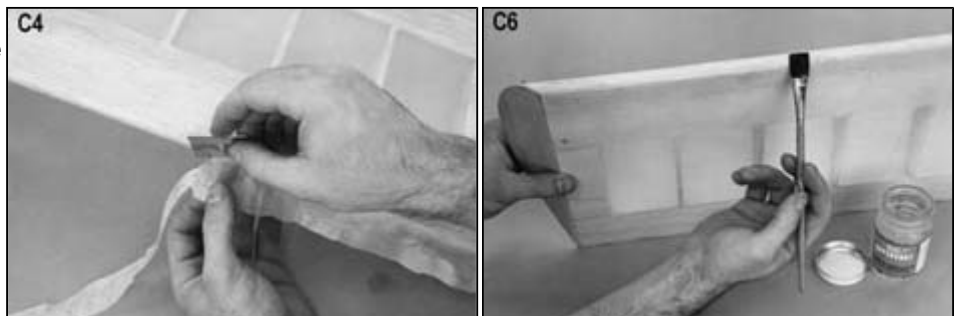

The top half is done in identical fashion except that the silk should be brought down over the edges instead of being trimmed flush. On the front, lap the silk over the edge of the bottom, over-lapping about 1/8". At the back, bring the material down over the back edge of the trailing edge but do not lap it over the bottom covering.

Use the same process on the tail section and fuselage.

Allow the water to dry out of the wood before applying the first full coat of clear dope. On the open framework area on the wing, brush the dope on sparingly. If too much is applied, the dope will be rubbed through the material and will run down the the surface on the inside and form a puddle. When these puddles dry, the large amounts of dope solids in them cause more shrinkage than the rest of the covering and a scarred area results. So apply dope very lightly the first time over. A second coat will seal most of the pores of the material and from this point, running through will not be a problem.

Use one or two coats of regular Supercoat clear on the wing to shrink the covering. After that, unless the covering is still not tight and unwrinkled, Sig Lite-Coat low shrink dope is recommended to help prevent warping. Sig Supercoat Color Dope is a low shrink base. A third coat of clear should provide a good base for color. Sand lightly when dry with 220 grit 3M Tri-M-lte no-load paper. Don't bear down on the edges of the ribs or the silk fibers will be cut through. The color dope may be brushed or sprayed.

Supercoat Color Dope should be thinned with Supercoat Thinner for brushing. This helps prevent brush marks and gives smoother coats. Flow on wet coats and avoid rebrushing back over an area already painted. If brush marks show, you need more thinner. For spraying, thin dope about 50-50. Add more thinner if the dope does not go on evenly.

If high humidity causes the dope to "blush" or turn white, the best way to handle this problem is to wait until the humidity situation improves and apply another coat of dope. This will eliminate the blush. If it is necessary to dope during high humidity, Sig Retarder may be used in place of part of the Supercoat Thinner (amount depends on the humidity) to reduce the tendency to blush.

Color coats can be sanded with 360 Tri-M-Lte or 400 or finer wet paper. When using masking tape for trimming, seal the edge with a coat of clear dope to prevent the color dope from bleeding under the edge. Don't leave the masking tape on any longer than necessary. The longer it is on, the harder it sticks.

Masking off curved parts for painting is made much easier if 1/8" wide masking tape is used. This will bend around corners easier than wider tape. Strips can be cut off of regular tape with a straight edge. After the decoration is outlined, wider tape can be joined onto the 1/8" tape to block off the nearby areas not to be painted. I use paper taped on to much of the rest of the model to shield for spray painting.

Another way the curved parts of the decorations and pinstripes can be applied is with the use of a mechanical drawing ruling pen to draw them on the model using paint in the pen instead of ink. Thin dope slightly with blush retarder to slow the drying process and aid the flow of dope through the pen points. Clean the pen frequently with dope thinner and wipe on a cloth before reloading with fresh dope. Don't try to draw a thick line with the dope and pen but instead draw a thin line on each side of the desired pin stripe (about 1/8" wide were used on the original) and fill in between the lines using the pen free hand and opened up for wider flow. If you have a steady hand, use a small brush. Use a French curve to outline curved parts of the decorations.

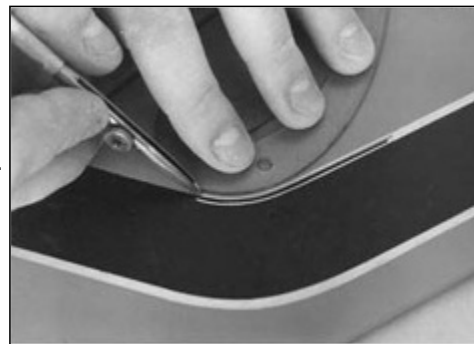

Complete the job with several sprayed coats of clear over the color scheme. This seals the colors and adds gloss. For best results, it is not a good idea to try to mix different brands of paint.

DECALS - Stik-Tite Pressure Sensitive

Cut out the decals with a pair of sharp scissors. Leave about 1/32" to 1/16" of clear edge around the decal. Round the corners as you are cutting. Wet the surface on which the decal will be placed with soapy water (use dishwasher detergent). Place the decal on the model and squeegee the water from underneath with a balsa paddle. Allow to dry. This procedure will prevent air from being trapped underneath as is possible when the decals are applied dry.

FINAL ASSEMBLY

Installing Easy Hinges

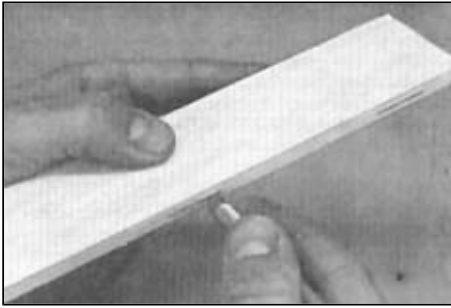

Using a No. 11 X-Acto blade (or similar) cut a slot approximately 1/2" in depth and slightly wider than the hinge. After all slots have been cut, insert an Easy Hinge halfway into each slot in one of the pieces to be hinged. Then carefully slide the matching model part onto the other half of the hinges. You'll find it easiest to slide the part onto the hinges at an angle, one hinge at a time.

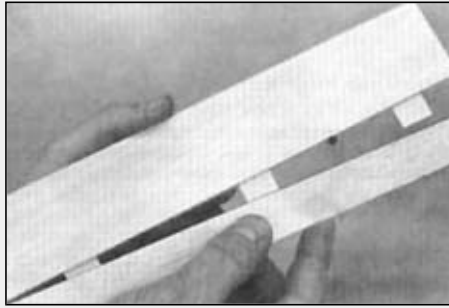

At this point the surface to be hinged is attached but not glued. Align the two surfaces and adjust the gap between them as required. For best control response, the gap should generally be as small as possible but big enough to allow the control surface to move to the maximum deflection that you require.

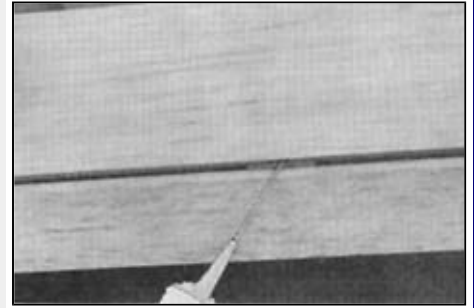

Place three or four drops of any brand cyanoacrylate adhesive (thinnest variety) directly onto the Easy Hinge in the gap. You will notice that the glue is quickly wicked into the slot as it penetrates both the wood and the hinges. Then turn the surfaces over and repeat the gluing process on the other side of each hinge. After the glue has cured, approximately three minutes, the joint can be flexed. You may notice a slight stiffness in the joint. This can be eliminated by flexing the surface to full deflection each direction a couple of dozen times. Don't worry about shortening the life of the hinge as they are almost indestructible.

BALANCING

Read "Why Models Must Be Individually Balance" and "Balance is Part of the Trimming Process" boxes on the full-size plan.

The suggested balance point for the Kadet Seniorita is shown on the plan. Balance with an empty fuel tank but with all the other equipment installed and the model completely finished and painted. Suspend the model from the wing tips at the balance point. It should hang from the finger tips approximately level.

If the tail hangs down at the desired balance point, it is tail heavy. Add lead or weight to the nose or shift the radio equipment as necessary to get it to sit level. Do not attempt flight in a tail heavy condition.

If the nose hangs down below level, the model is nose heavy. If it is only a little nose heavy, don't do anything about it, it will be okay to go ahead and test fly. If it is more than a little nose heavy, correct by moving the radio batteries out of the nose and as far back in the cabin as is necessary to achieve balance. When slightly nose heavy, the model is more stable and less likely to stall or snap roll from over-elevating. It also cuts down reaction of the model to control movements and this is good during test and practice flights, to help prevent over-controlling. In the nose heavy positions you will probably need more elevator movement to get the nose up in low throttle and glide than in other C.B. positions, so make sure you have sufficient elevator travel.

Make any changes in the balance position gradually, checking results and the effect of the change on control responses and the performance of the model in the air.

CONTROL MOVEMENTS

Various brands of servos can give different control movement direction and amounts of travel. For this reason, follow the measurements given when setting the Kadet Seniorita up for flight rather than any particular horn hole drawn on the full-size plan.

Shift the RC link to whatever horn hole will produce the amount of movement shown in the drawings. Measurements are made at the trailing edge of the control surface.

Control measurements are suggested as a beginning. Test flights may indicate a need for more or less movement, depending on individual model differences, center of gravity (C.G.), location etc.

Flight tests may determine that the neutral point should vary slightly from level but for illustration the neutral point is shown level.

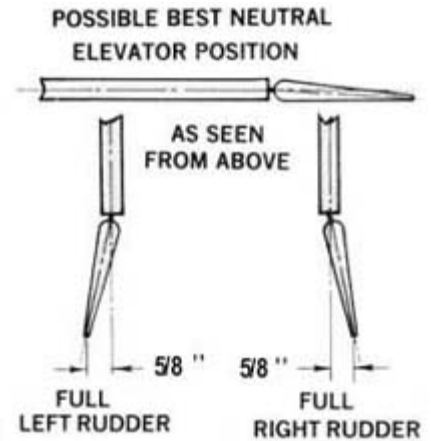
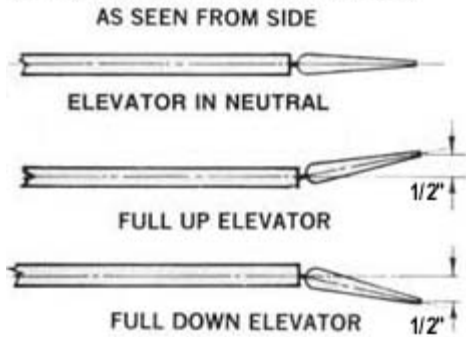

It is not uncommon for the Kadet elevator neutral position to test out to be slightly drooped down from level. This introduces some nose down trim to keep the model from climbing when the transmitter stick is in the center. The exact best neutral elevator position for each particular model must be determined during flight testing. With the model flying at about 3/4 throttle, feed in down trim with the transmitter lever until the model flies level. Land and observe this position of the elevator. Adjust the elevator pushrod as required to keep this flight checked "neutral" position when the transmitter trim level is returned to the center.

FLYING

To Fly The Kadet Senioria On A 4 Channel Radio

Plug the rudder servo in the fuselage into the receiver outlet marked aileron. Use of the aileron stick on your radio equipment to operate the rudder will enable you to develop the proper left and right reactions that will later be needed when advancing to aileron control, using the same hand. If you plugged the rudder into the rudder socket when only using 3-channels, you would have to make a difficult transition from one hand to the other at the time you advanced to aileron control, just about the same as starting over. The most important thing you are learning in the early stages is an automatic left and right reaction on a particular transmitter stick with a particular hand. Forget which control surface is doing the turning on a 3 channel, assume that the rudder is an aileron.



Flying The Kadet Seniorita On Two Channels

3 channels are best, but the Kadet can be flown on 2 channels when this is necessary. We recommend use of rudder and elevator control for the two channels. Motors above .15cu. in. in size should be run throttled back to about 3/4 power by tying down the throttle arm at the desired speed.

Altitude gain on two channels is controlled by use of elevator down trim or application of down elevator stick movement when required. On first test flights with a 2-channel Kadet, fill tank 1/2 full. This will help keep the model from gaining too much altitude if the trim is not set properly at first and the rate of climb is excessive.

Another way is to use rudder and engine control on the two channels but the range of maneuvers possible are more limited in this mode.

Be certain to carefully range check your radio equipment and see how it operates with the engine running before attempting test flights. A lot of problems can be avoided if the engine has been well broken-in and the idle adjustment perfected on a test block or in another airplane.

Takeoffs from grass fields are easily made if the grass is not too long or the ground too rough. Generally a lot of elevator application is required for liftoff. Be prepared to relax control pressure partially after becoming airborne so the climbout will not be too steep. On surfaced or smooth dirt runways less application of elevator will be needed.

If a good smooth take-off surface is not available, the model can be hand launched by the pilot's assistant. (Do not attempt to hand launch by yourself - instant action on the transmitter may be required.) Holding the front part of the fuselage with the left hand and under the tail with the right, run into the wind at a fast trot and thrust the model forward with the nose slightly up in a spear throwing motion. It is not necessary to achieve a lot of velocity in the launch - it is more important that it be released smoothly and with the wings level. The model may dip slightly and then should begin climbing at a slight angle. If it does not begin to climb after about fifty feet of flight, apply a small amount of up elevator to lift the nose.

Use the rudder to keep the wings level and headed straight into the wind until about 75 feet of altitude is obtained. Keep first turns gentle and not steeply banked. Stay up wind of the transmitter. Use trim levers on your radio equipment where necessary to obtain straight and level flight with the control sticks in neutral position but don't attempt to make these adjustments until the model is at a good altitude. Throttle back at altitude to find out the model characteristics in a gliding condition so that some indication is seen of what to expect during the landing approach. It is a good idea to make several practice landing approaches at a good altitude to get the feel of the model for this approaching critical maneuver. Make your final and complete landing approach while your engine still has plenty of fuel remaining so that the engine is not liable to stop before completion of the flight. This will allow application of power if the approach is being under shot. Notice the percentage of missed landings at an R/C field. Those undershot greatly outnumber those missed by overshooting. So if an approach that looks a little high is maintained, chances are good that a spot-on landing can be made.

After you get through the first flights, you should begin to "trim" the model's control surfaces. If it is turning to the right, for example, with the stick in neutral, and you must move the transmitter trim lever to the left to make the model fly straight, then land the model and position the rudder to the left of center by turning the RC link on the pushrod one or two turns on its threads. Check in the air for the result. Repeat the process, if necessary, until the trim lever is centered when the model is flying straight with the stick in neutral. You may find that the reaction of the model is different to high power and low power, requiring changes in trim lever position during flight, as for a landing approach. This is one of the controls you must learn to operate during practice flying, but it is not a critical matter at first since these minor corrections can be made with stick movement alone as you are steering the model along its course.

EASING THE TRANSITION FROM 3 TO 4 CHANNEL FLYING

In the first paragraph of the Flying section of the Kadet instructions, we tell you to fly the model by connecting the rudder servo to the transmitter stick normally used for ailerons so that when you move on to a 4 channel model after learning to fly there will be no hand switching required other than the change for nose wheel steering on the ground. If you have a 4 or more channel radio to put in the Kadet, transition to aileron control can practically be eliminated by hooking the nose wheel to a 4th servo instead of the Kadet's rudder servo. Then the transmitter rudder stick can be used for ground steering and the aileron stick for in-the-air turning as you will be doing on 4-channel aircraft.

RUBBER BANDS ON WING

Remember that different brands of rubber bands have different stretch characteristics. Apply some common sense judgement to the number of rubber bands used. It is a good idea to stretch each new band to its limit before using to locate any hidden defects. In case of doubt as to whether or not the wing is on securely, add extra rubber bands. Loading a wing in flight is more destructive than failure of the wing to come off in a hard landing. We looped two no.64 bands together to form a longer band and then used 10 of these looped-together units to hold the wing on, 5 crisscrossed each way. Glue a piece of scrap plywood or plastic on the trailing edge at the point the wing rubber bands go over the edge to keep them from cutting into the wing. This should be done after covering.

DON'T WALLOW AROUND THE SKY!

A common mistake made by beginners is to fly around with the model having too much up trim. It climbs out steeply under full power in this condition (and is probably a safety factor for a rank beginner) and you can level it off by throttling back on the motor. However, in this over-up condition it wallows around with the nose high, it is hard to turn properly, and it will not fly into the wind because of low airspeed. The solution is to apply some down trim to the elevator to bring the nose down and make the model fly more nearly level at cruising power. It may be necessary to drop the elevator a bit from level by screwing in the RC link on the elevator pushrod to get enough down. The way to learn to do this trimming process is to experiment with the model in the air and note it's reaction to increased down trim or other changes. Moving the center of gravity in combination with trim changes can also alter the flying characteristics. For example, you may find that the balance point specified for test flights will be okay for the first few flights but when the model is trimmed down to fly more level under cruising power you may find that moving the balance point will give you better performance.

It is impossible to give exact directions for every case, since individually built models vary slightly and the engine used also affects results. But if the model is not flying in a satisfactory manner, then chances are it is not trimmed properly and should be adjusted accordingly. Do a little tinkering, a bit at a time. This is an instructive way to fathom the mysteries of perfect trim and in the process you can improve your flying.

Ground Attitude

The position of the landing gear affects the performance of the model during takeoff and landing. A position that makes it easy to take the model off may not work well on landing. Conversely, if the model is easy to land it may be difficult to lift off. In designing a model we choose a location that we feel represents the best compromise between takeoff and landing characteristics. Sometimes an individual flier may find this position not quite suited to his personal preferences or skills. So we are explaining below some alterations that can change either the takeoff or landing characteristics if desired. To alter the standard level ground attitude, use different size wheels, bend the main gear or lock the nose gear in a different position, using the set screw on the nose gear steering arm or a wheel collar as previously described.

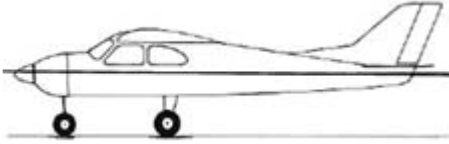

Model in Level Ground Attitude

This is the standard kit configuration as shown on the full size plan.

Model in Nose Down Ground Attitude

Lands easily and stays on the ground with little or no bounce. Excess landing speed can more easily be tolerated with this configuration. Takeoff is more difficult. The model will run on the ground at high speed without lifting off because the wing is at a negative angle. Extra up elevator movement of the stick is required to lift the nose wheel off the ground and then the model may zoom up sharply as it lifts off. If the flier is prepared to relax the up elevator promptly upon lift off, it can be managed OK. This nosedown ground attitude is good for fliers who can handle takeoffs competently but are unable to land in good shape. (The average beginner usually learns to takeoff sooner than he acquires landing skill.)

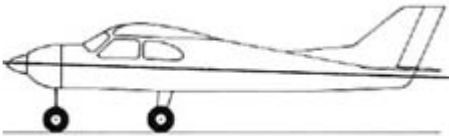
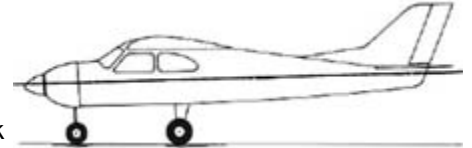

Model in Nose Up Ground Attitude

Lifts off easily and smoothly in a scale-like manner with just a touch of up elevator. In the case of a Kadet, it may even takeoff by itself without pulling in up elevator with the stick. Landings are more difficult because the nose wheel can touch down before the main wheels, causing the model to rock backward onto the mains and/or bounce several times before sticking on the ground. If the

landing speed is excessive, the first bounce may make the model become air-borne again. When using this ground attitude, the air speed on landing must be reduced, the model flared nose high and touchdown made on the nose wheel and main gear simultaneously or on the main gear first. This configuration requires better flying skills than does the kit configuration level attitude or the nose down attitude.

TAPPING ALUMINUM ENGINE MOUNTS

Clamp the engine mount securely in a vise and center punch the motor mounting holes. Drill the holes with a sharp twist drill bit in a variable speed electric drill. If possible, use a drill press instead of a hand held drill. Lubricate the drill bit with machinist's cutting oil, special aluminum tapping fluid, or other light household oil such as Marvel or 3-in-1.



Run the drill at a moderate speed with moderate pressure. Let the bit cut its way through the aluminum at its own rate. Don't try to force it with excess pressure or high speed. Aluminum galls easily and may jam and break the bit if forced. If resistance builds up, back it out of the hole frequently and clean off the metal fragments. Relubricate the bit and hole with oil and continue drilling.

Tapping the drilled holes is easy if the same precautions are taken. Lubricate the tap liberally with cutting oil. Use moderate constant pressure when turning the tap into the hole. If resistance builds up, back the tap back out frequently and clean the fragments out of the threads. Use plenty of oil and work slowly.

© Copyright SIG Mfg. Co., Inc.

SIG Mfg. Co., Inc.....Montezuma, Iowa 50171-0520

LIMIT OF LIABILITY:

In use of our products, Sig Mfg. Co.'s only obligation shall be to replace such quantity of the product proven to be defective. User shall determine the suitability of the product for his or her intended use and shall assume all risk and liability in connection therewith.