

# ASSEMBLY MANUAL



# RASCAL 110



KIT NO.: SIGRC84EGVARFB - (White / Trans Blue)  
SIGRC84EGVARFR - (White / Trans Red)

**ALMOST READY TO FLY**



**Fly with  
Glow, Gas, or  
Electric Power!**

#### **SPECIFICATIONS:**

<b>Wing Span:</b>	110 in.	(2794 mm)
<b>Wing Area:</b>	1522 sq. in.	(98.2 dm <sup>2</sup> )
<b>Length:</b>	75.75 in.	(1924 mm)
<b>Flying Weight:</b>	11 - 13 lbs.	(4990 - 5897 g)
<b>Wing Loading:</b>	17 - 20 oz./sq.ft.	(51 - 60 g/dm <sup>2</sup> )
<b>Glow Power:</b>	2-Stroke 1.2 - 1.5 cu. in.	(20 - 25 cc)
	4-Stroke 1.2 - 1.8 cu. in.	(20 - 30 cc)
<b>Gas Power:</b>	1.2 - 1.8 cu.in.	(20 - 30 cc)
<b>Electric Power:</b>	1600 - 2600 watt (200-270 kv) Brushless Motor; 80-120A ESC; 8S-12S Lipo Battery Pack	
<b>Radio Required:</b>	<b>for Glow or Gas:</b> 5-Channel with 7 Heavy-Duty Servos Ail(2), Elev(1), Rud(1), Thro(1), Flaps(2)	
	<b>for Electric:</b> 5-Channel with 6 Heavy-Duty Servos Ail(2), Elev(1), Rud(1), Flaps(2)	



**SIG MFG. CO., INC. PO Box 520 Montezuma, IA 50171-0520**  
**www.sigmfg.com**



## RASCAL 110 EG ARF ASSEMBLY MANUAL

### INTRODUCTION:

Congratulations on your purchase of the RASCAL 110 EG ARF. We predict that you are going to fall in love with this airplane. Take-offs and landings are spectacular in their smoothness, and when it comes to what goes on in the air, the Rascal 110 is positively elegant. Exceptional streamlining and a high performance airfoil allow the Rascal 110 to do things other high wing airplanes can't do. Slow rolls, point rolls, easy inverted flight, Cuban 8s, etc. ... are all part of the Rascal 110's aerobatic routine. The light wing loading of the Rascal 110 makes it a versatile workhorse. Float flying, banner or glider tow, onboard video or camera work (several universities and the military are using them), parachute drop, night flying with add-on lights, and just about any other load carrying task is easy for the giant RASCAL 110. You won't find a better behaved, more honest airplane than this superb flying machine!

The RASCAL 110 ARF can be assembled and ready for the flight line in a few short evenings. The all-wood airframe is CNC laser cut and factory jig built. That means the few parts you need to glue together are guaranteed to fit "like a glove". The airplane is expertly covered with Ultracote® (aka ORACOVER®) premium covering material. The factory-painted cowling and wheel pants are quality hand-laid fiberglass. The functional airfoil shaped aluminum wing struts and massive spring aluminum landing gear are also factory-painted and ready to bolt on. The leaf-spring tailwheel assembly is completely assembled and ready to use. The kit also includes complete hardware, wheels, spinner, fuel tank, and a fully illustrated assembly manual that leaves nothing to the imagination.

Assembly of the Rascal 110 is fast and simple when following the detailed instructions in this manual. We urge you to read this assembly manual completely before assembly. Familiarize yourself with the parts and the assembly sequences. The successful assembly and flying of this airplane is your responsibility. If you deviate from these instructions, you may wind-up with problems later on.

We hope you will enjoy this legendary R/C model. We're confident you will love the way it flies! Let's get started!

### ADDITIONAL ITEMS YOU WILL NEED TO PURCHASE

In addition to this kit, you will need the following items to complete your RASCAL 110 and make it flyable.

### POWER SYSTEM

The sky is the limit on choosing a powerplant for this versatile airplane. The RASCAL 110 flies beautifully with 2-stroke glow,

4-stroke glow (single or twin cylinder), gas, or electric power. Keep in mind that the airplane has been designed to be relatively light, producing a good flying model with a very favorable wing loading. In addition, the design is aerodynamically clean for a high-wing model. These two factors result in very good performance when using engines in the suggested range. Over-powering this model is totally unnecessary and not recommended.

### GLOW ENGINE

We recommend the following sizes for the RASCAL 110.

**2-Stroke - 1.20 - 1.50 cu. in. (20 - 25 cc)**

**4-Stroke - 1.20 - 1.80 cu. in. (20 - 30 cc)**

Some glow engines that have been popular in the RASCAL 110 are: Saito 1.50 and 1.80 single cylinder 4-stroke; O.S. 1.20 single cylinder 4-stroke; O.S. 1.20 and 1.60 twin cylinder 4-stroke;

***Note:** In the installation of a twin cylinder engine, the only real issue is how to install the fiberglass cowl over the two cylinder heads. We have made a twin cylinder installation (OS Gemini 1.60 Twin) and found the best way to deal with the cowl is to neatly "split" it, from front to rear, along the centerline of the engine, creating top and bottom cowl halves. The two halves could then be joined along the seam with small bolts. Neatly done, this would create fairly easy engine access and a very realistic look.*

### GAS ENGINE

We recommend the following sizes for the RASCAL 110.

**1.20 - 1.80 cu.in. (20 - 30 cc)**

Some gasoline engines that have been popular in the RASCAL 110 are: Syssa 30 (30 cc); Zenoah G26 (26 cc); DLE 30 (30 cc); FPE 1.3 (21 cc); Evolution 26GT (26 cc)

### GLOW & GAS ENGINE USERS

Because of the wide variety of engines that can (and have) been used in the RASCAL 110, it is virtually impossible for us to cover every installation, and answer every possible question, in detail. Two-stroke, four-stroke, and gas engines often use different styles of engine mounts; different types and sizes of fuel tanks; and have different pushrod requirements. Some engines come with a mount, especially gas engines. Rather than put engine mounts and fuel tanks in this kit that most of you won't be able to use, we are leaving it up to you to supply your own engine mounts and fuel tanks. There is a basic wire pushrod included, with a nylon sleeve, pushrod connector for one end, and metal clevis for the other end. This type pushrod will for many engine throttle hookups (but not all - you may need to acquire other after market parts).

### ELECTRIC POWER SYSTEM

For electric power we recommend a

**1600-2600 watt (200-270kv) Brushless Outrunner Motor  
80-120 amp high-voltage electronic speed control (ESC)  
8s to 12s 5000 mAh Lithium-Polymer Battery Pack (Lipo)**

Suitable motors in this range that have been used in the Rascal 110 are sometimes referred to as "120" or "160" equivalent motors. Actual measurements were 6332-230 and 6364-245, with the first 63 being the actual case diameter in millimeters. The second two digits refer to the motor armature or the case length in mm, while the last three digits are the kv rating of the motor.

**MOTOR MOUNT:** A laser-cut plywood adjustable motor mount is included in this kit. It should work perfectly for any suitable brushless outrunner motor which has an "X" or "cross" motor mount plate on the back.

**PROPELLER:** Brushless motors of this size typically use propellers from 16 to 20 inch diameter. However, with electric powered models, there are many factors that have a bearing on what propeller to use. The best place to start answering the question is in the instructions that come with your motor. Another fine source of information is one of the electric flight calculators that are available for you to use free online (there is a good one on Castle Creations web site).

**Caution:** You must always match your propeller size to your motor and to the cell count of your lipo battery pack, to avoid drawing too many amps and damaging your ESC or motor.

**ARMING SWITCH:** We strongly recommend the use of an arming switch (not supplied) for your motor system. An arming switch mounts in the side of your airplane and it disconnects the positive wire between the battery pack to the ESC. With the arming plug out the motor cannot start up. The battery pack can be loaded into the airplane and plugged into the system before going to the flight line. Once you're on the flight line with the radio on, ready for takeoff, you "arm" the system by plugging in the arming plug, completing the circuit. Shown is a typical arming switch harness, this one sold by Maxx Products® (www.maxxprod.com).

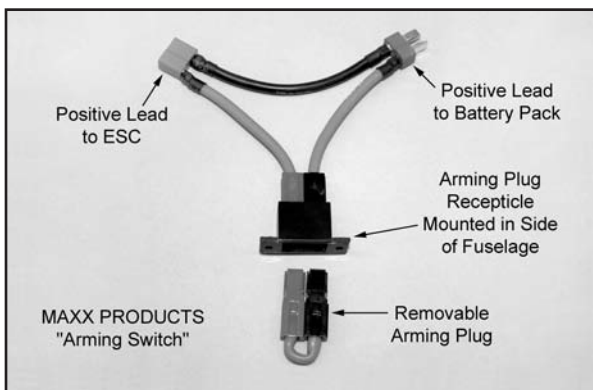

### BATTERY CHARGER

FOR SAFETY AS WELL AS PERFORMANCE, CHARGE LIPO BATTERIES ONLY WITH A LIPO BATTERY CHARGER!

In addition to providing the critical charging profile needed to safely charge lipo batteries, a lipo battery charger also includes the capability of "balancing" the available voltage in the cells, ensuring that the battery pack is at peak capacity at the end of the charge cycle. This translates to better flight times and a longer life from the battery pack.

### CHECK THE INTERNET FORUMS

Since the RASCAL 110 has an almost 10 year history, there is a wealth of good how-to information available on the internet model airplane forums, like RC GROUPS, RC UNIVERSE, and FLYING GIANTS on many engine installations. If you do an internet search of the words "Rascal 110" and the engine you are considering, you will most likely find good first-hand experience from flyers who have already done that particular installation.

### RADIO SYSTEM:

#### DECISION TIME: FLAPS OR NO FLAPS?

Before talking about the radio system, you need to decide if you are going to use the optional flaps. The first generation RASCAL 110 did not have flaps. With its long wing and light wing loading, it could be a real "floater" on landing. If your engine idle speed was a bit too high, it didn't want to come down! Several flyers expressed interest in having flaps, so this new generation RASCAL 110 has been built with flaps. Whether to use them or not is your decision. If you don't want operating flaps for whatever reason (maybe you don't want to buy two more servos), you can simply glue, tape, or some other

way of your own design, secure them securely in the up position. Clear tape or covering material is a good method because it can be removed later if you change your mind. Whatever you do, if you aren't using the flaps, make sure they are secure and cannot move from neutral position.

### CHANNELS

The RASCAL 110 requires a minimum 5-channel radio system when using the flaps, or a 4-channel radio system without the flaps. We highly recommend the use of a modern programmable computer radio. Such radio systems allow you to easily set and adjust every channel and additionally program various flight functions to suit your individual style of flying. How many servos you need will depend on what type of powerplant you are using and whether or not you are using the flaps.

### SERVO REQUIREMENTS

Ailerons - two (2) heavy-duty servos with at least 75 in/oz of torque  
 Flaps - two (2) heavy-duty servos with at least 75 in/oz of torque  
 Elevator - one (1) heavy-duty servo with at least 75 in/oz of torque  
 Rudder - one (1) heavy-duty servo with at least 75 in/oz of torque  
 Throttle - one (1) standard servo with 40-60 in/oz of torque

### SERVOS FOR GLOW OR GAS ENGINE POWER

If using the flaps, you will need total of 7 servos - ailerons(2), elevator(1), rudder(1), flaps(2) throttle(1).

If not using the flaps, you will need total of 5 servos - ailerons(2), elevator(1), rudder(1), throttle(1).

### SERVOS FOR ELECTRIC MOTOR POWER

If using the flaps, you will need total of 6 servos - ailerons(2), elevator(1), rudder(1), flaps(2).

If not using the flaps, you will need total of 4 servos - ailerons(2), elevator(1), rudder(1).

### SERVO CORDS NEEDED

Ailerons - two (2) 24" long servo extension.cords  
 one (1) standard Y-harness cord (plugged into the rx)  
 Flaps - two (2) 6" long servo extension cords  
 one (1) reversing Y-harness\* cord (plugged into the rx)  
 Elevator - one (1) 36" long servo extension cord  
 Rudder - no extra cords needed  
 Throttle - no extra cords needed

\* We used a Maxx Products® "Miracle-Y" Reversing Y-Harness Cord.

Some of you may prefer to wire your aileron or flap servos into your receiver by a different method, which will change the above list. For instance maybe you prefer to eliminate the Y-harness and plug your flap servos directly into two different ports on their receiver, and then link them with your programable radio. Plan out your installation in advance and acquire the cords you will need.

### SERVO ARMS

We like to use Du-Bro® after-market servo output arms. These are exceptionally strong and always seem to be the right shape and geometry for most of our applications. Du-Bro® makes their output arms to fit any available servos, just use the right part number for your particular brand of servos. Because our assembly manual model is using Hitec® servos, we chose the Du-Bro® #675 set.

### RECEIVER BATTERY PACK

Do not attempt to fly the RASCAL 110 with a 4-cell (4.2 volt) nicad or nimh battery pack. That is not enough volts for an airplane this large with as many as 7 high torque servos. The old standard 4-cell 500-600 mAh receiver packs are intended for 40-60 size airplanes with only 4 servos. **Use a 5-cell (6.0 volt) nicad or nimh battery pack, or a 2-cell (7.4 volt) lipo pack in your RASCAL 110 to run the receiver and servos.** Otherwise you risk a low-voltage situation that could send your



radio into fail-safe and cause a crash. **(Be sure to check your receiver and servo specifications for min and max allowed voltage when selecting a receiver battery pack - especially if going above 6.0 volts with a lipo pack - you may need high voltage servos to use lipo.)**

We also recommend that your receiver battery pack have a 1500-2000 mAh capacity. Be sure you have a charger capable of properly charging these larger battery packs.

No radio equipment is supplied in this kit. Heavy-duty servos, extension cords of various lengths, and Y-harness cords are all available separately from your radio manufacturer. Check their website, or see your local hobby shop for more information.

### REQUIRED TOOLS

For proper assembly, we suggest you have the following tools and materials available:



A selection of glues - SIG Thin, Medium, & Thick CA Glue  
CA Accelerator, CA Debonder  
SIG Kwik-Set 5-Minute Epoxy

- Screwdriver Assortment
- Pliers - Needle Nose & Flat Nose
- Diagonal Wire Cutters
- Small Allen Wrench Assortment
- Pin Vise for Small Dia. Drill Bits
- Hobby Knife with Sharp #11 Blades
- Small Power Drill With Selection of Bits
- Dremel® Tool With Selection of Sanding & Grinding Bits
- Scissors
- Sandpaper
- Heat Iron & Trim Seal Tool
- Masking Tape
- Paper Towels
- Alcohol and/or Acetone For Epoxy Clean-up
- Threadlock Liquid (such as Loctite® Non-Permanent)

### COMPLETE KIT PARTS LIST

The following is a complete list of all parts contained in this kit. Before beginning assembly, we suggest that you take the time to inventory the parts in your kit. Use the check-off boxes  provided in front of each part description.

- (1) Fuselage
- (1) Right Wing w/ Aileron & Flap, hinges not glued
- (1) Left Wing w/ Aileron & Flap, hinges not glued
- (1) Stabilizer & Elevator, hinges not glued
- (1) Fin & Rudder, hinges not glued
- (1) Fiberglass Cowling
- (1) Right Plastic Side Window
- (1) Left Plastic Side Window
- (1) Plastic Windshield
- (1) Aluminum Main Landing Gear
- (1) Right Fiberglass Wheel Pant
- (1) Left Fiberglass Wheel Pant
- (1) Aluminum Tube Wing Joiner

- (1) Balsa Triangle Stock
- (1) Right Wing Strut
- (1) Left Wing Strut
- (1) Plywood Electric Motor Mount
- (1) Plywood Battery Tray
- (2) 3-3/8" long Wire Pushrod, threaded both ends, w/ Hex Nuts; for flaps
- (2) 4" long Wire Pushrod, threaded both ends, w/ Hex Nuts; for ailerons
- (1) 5" long Wire Pushrod, threaded both ends, w/ Hex Nuts; for elevator
- (1) 17-3/4" long Wire Pushrod, threaded one end, w/ Hex Nut; for throttle
- (1) 15" long Nylon Pushrod Tube, for throttle pushrod sleeve
- (2) Velcro® Straps
- (2) 4" dia. Main Wheels
- (2) Plastic-coated Steel Pull-Pull Cables
- (4) Metal Pull-Pull Swage Tubes
- (8) Magnets (removable side windows for electric power)
- (1) Tailwheel Assembly, with Steering Arm
- (3) M3 x 20mm Socket-Head Bolts, for mounting tailwheel
- (1) Metal 3-Arm Rudder Steering Horn
- (2) M2.8 x 15mm Screws; for mounting rudder steering horn
- (2) Coil Steering Springs
- (2) M6.5 x 45 mm Nylon Wing Bolts
- (1) M4 x 20mm Nylon Bolt; for battery/tank tray
- (4) Brass Pull-Pull Fittings; for rudder
- (4) M2.7 Hex Nuts; for pull-pull fittings
- (14) M2.7 Metal Clevis; for ail(4), flaps(4), rud(4), ele(2)
- (1) M1.7 Metal Clevis; for throttle pushrod
- (1) Pushrod Connector w/ Set Screw; for throttle pushrod
- (15) Short pieces of Fuel Tubing; for clevis keepers
- (5) Nylon Control Horns w/ Clamp; for ail(2), flaps(2), ele(1)
- (2) Nylon Control Horns w/o Clamp; for pull-pull rudder
- (12) M2 x 30mm Bolts; for control horns, ail(6), flaps(6)
- (6) M2 x 20mm Bolts; for control horns, elev(3), rudder(3)
- (18) M2 Hex Nuts; for control horns
- (23) M2.3 x 7mm Screws; for windshield & ail./flap hatches
- (6) M3 x 10mm Sheet Metal Screws, for cowling
- (4) M3 x 12mm Socket-Head Bolts, for wheel pants
- (12) M4 x 20mm Socket-Head Bolts, for landing gear(4), electric motor(4), wing struts(4)
- (4) M4 x 25mm Socket-Head Bolts; for electric motor mount
- (4) M4 Flat Washers; for electric motor mount
- (8) M4 Lock Washers, for landing gear(4), electric motor(4)
- (8) M4 Blind Nuts; for electric motor & mount
- (2) 4mm dia. Axles
- (2) Large Hex Nuts; for axles
- (4) 4mm ID Wheels Collars w/ Set Screws; for axles

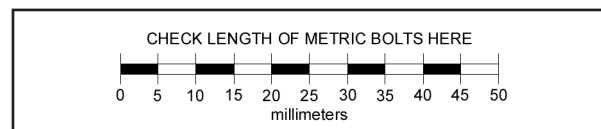

### COVERING MATERIAL

Your RASCAL 110 is covered with Oracover®, a premium quality covering made in Germany, and sold in the U.S. by Hanger-9 as Ultracote®.

#### Colors

Oracover® #10 White (Ultracote® #HANU870)  
and

Oracover® #29 Transparent Red (Ultracote® #HANU950)  
or

Oracover® #59 Transparent Blue (Ultracote® #HANU954)

If sometime in the future you need replacement covering or matching paint for repairs, they are available from your local hobby dealer or online from Hanger-9.

### How To Tighten Loose Covering

After you open your RASCAL 110 and take all the covered parts out of their plastic bags, the covering may begin to wrinkle. This is not unusual and is no cause for alarm.

Your airplane was built and covered in a part of the world, which has relatively high humidity and therefore, the wood was likely carrying a fair amount of moisture. When exposed to drier air, the wood typically loses this moisture, dimensionally "shrinking" in the process. In turn, this may cause some wrinkles. However, wrinkles are easy to remove by just using a hobby type heat iron. **Caution:** Trying to remove the wrinkles by hastily going over them with a heat gun can lead to more problems. You should take your time to carefully go over the entire model with a covering iron, as we will describe.

We suggest using a model airplane covering iron for this process. Cover the iron's shoe with a thin cotton cloth, such as an old t-shirt, to prevent scratching the covering as you work.

After covering your iron, the next step is to set the iron to the correct temperature. This is critical for achieving a good result! The iron should be set to about 220°F - 250°F (104°C - 121°C) as measured on the bottom of the iron using a thermometer. This is the recommended temperature for adhering the covering.

If you do not have a thermometer, you can find the correct temperature by trial and error. Set your iron to a medium setting. Glide the iron over some of the covering that is over solid wood, such as the sheeted wing center section. Observe the covering to see if any bubbles appear. If bubbles appear, the covering is getting too hot! Turn down the temperature of the iron. If no bubbles appear, turn up the heat slightly and repeat the test. Keep adjusting until you "zero in" on the correct temperature. Find the temperature that will get the covering to stick down without forming bubbles or causing the seams to pull away.

Once your iron is set to the correct temperature, go over the entire framework of the airplane, making sure that the covering is securely bonded to the structure everywhere the covering comes in contact with the wood underneath. This takes some time, but is worth the effort.



After you have all the covering secured onto the solid areas, turn the temperature of the iron up to approximately 300°F - 320°F (149°C - 160°C). This is the correct temperature for shrinking the covering material.

Use the iron to tighten up any wrinkles in the "open" areas of the model (no wood underneath the covering). Glide the iron over

the wrinkle for a few seconds, then remove. Repeat until the covering is tight with no wrinkles.

If wrinkles keep coming back on the tail surfaces, you may need to "ventilate" the areas between the ribs. Otherwise the air that is sealed in those relatively small areas will expand when the heat is applied and actually cause the covering to stretch instead of shrink. Use a pin to poke a tiny hole in the covering between each rib, on the bottom of the part. That will let the expanding air escape and the covering to shrink properly.

**Caution When Using Heat Guns:** You can also use a hobby-type heat gun to shrink the covering, but you must be careful around seams or color joints. Getting too much heat on the seams may cause them to "creep" or come loose. You must also be careful when using a heat gun when working around the windshield and side windows - heat will distort the clear plastic material.

Recommended Temperatures:

To adhere the covering - 220°F - 250°F (104°C - 121°C)

To shrink the covering - 300°F - 320°F (149°C - 160°C)

**NOTE:** In this manual, any references to right or left, refer to your right or left as if you were seated in the cockpit of the airplane.

## WING ASSEMBLY

The wings are designed as a 2-piece system, with separate right and left wing panels joined by an aluminum tube wing joiner. Due to the high strength of the wing joiner tube, the wing panels do not need to be permanently glued together. Gluing them permanently together is optional - your call. The obvious benefit to leaving the wing panels separate is the fact that they can be easily transported or stored. To help protect your wings from unnecessary damage during the following steps, we recommend that you cover your work surface with an old blanket or piece of soft cell foam.

### HINGING THE AILERONS & FLAPS

As received in the kit, the wing panels have the ailerons and flaps hinged in place, but the hinges have not been permanently glued. Gluing the hinges will be the very first step. Use a slow setting glue that will give you plenty of time to work the hinges into place. If using epoxy we recommend using a slower setting time such as 30 min epoxy or longer. Traditional yellow or white water-based wood glue is another good choice for installing these hinges.

- 1) Remove the aileron and flap from the wing panel and then pull all of the hinges out of off their holes.
  - a) Spread a little dab of petroleum jelly or lithium grease on the pivot point of each hinge. Work it into the rivet and hinge area to prevent glue from seeping into the hinge and locking it up.

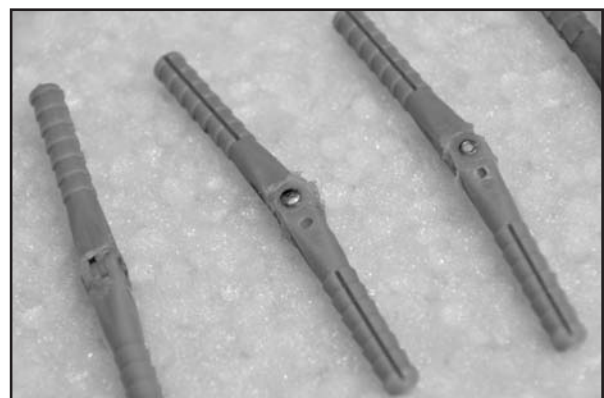

- b) Use a toothpick and apply a liberal amount of glue to the inside of the hinge holes on the back of the wing. Make sure the glue fully coats the inside of the holes. We suggest working with one control surface at a time.

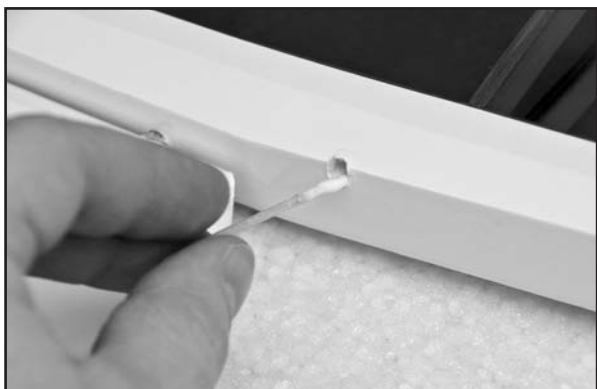

- c) Now use a toothpick to spread a thin coat of glue in the grooves of the hinge itself (just one side of the hinge). Then insert the hinge into the hole in the wing until the center of the hinge is up to the hinge line of the wing. Do this for each hinge for that control surface. Flex the hinges down 90° to ensure that the hinges are all in line and do not bind when the control surface is deflected.

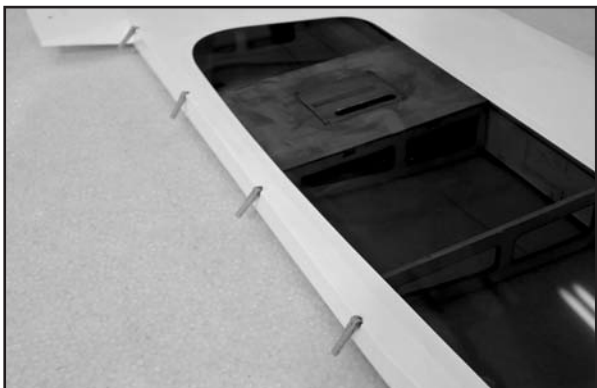

- d) Once the glue from on the hinges has dried, prepare some more glue and using a toothpick again coat the inside of the holes on the control surface you are working with. Be sure to apply a liberal amount of glue on the inside of each of the holes. Carefully line up all the hinges with the holes and push the control surface up to the hinge point. Be sure to watch for excess glue that might seep out onto the hinge point. Clean this off right away so it does not bind up the hinge. Flex the control surface up and down to make sure all the hinges are lined up without binding. If needed use some masking tape to hold the control surface in place while the glue cures. Let dry.

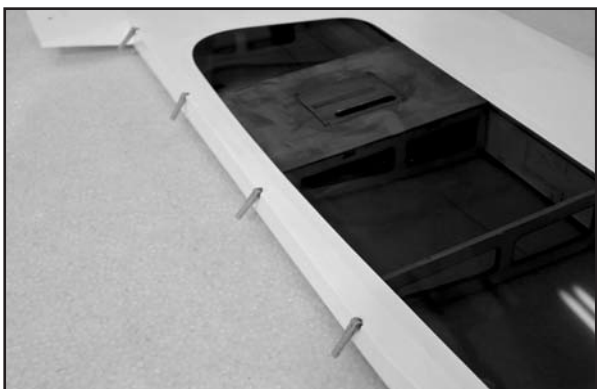

- e) Repeat steps a) through d) to permanently hinge both ailerons and both flaps to the wing panels.

## INSTALLING THE AILERON & FLAP SERVOS

For the following steps you will need:

- (1) Right Wing Panel
- (1) Left Wing Panel
- (16) M2.3 x 7mm Screws for servo hatches
- (4) Servos with Mounting Screws (not furnished)
- (2) 24" Servo Extension Cords for ailerons (not furnished)
- (2) 12" Servo Extension Cords for flaps (not furnished)
- (1) Dual Servo Y-Harness for ailerons (not furnished)
- (1) Reversing Dual Servo Y-Harness for flaps (not furnished)

It will be helpful to have your radio system charged and ready to use. It is a good idea to test and center your servos before installation to ensure everything is working and won't have to be removed right away for service.

- 2) Both aileron servos need a 24" extension cord in order to exit at the center of the wing. The standard dual servo Y-harness will be plugged into the receiver for the ailerons. When the wing is put on the airplane, the aileron extension cords are plugged into the Y-harness. Prepare the servos for mounting by installing the rubber grommets and eyelets (supplied with your radio system) in each servo. Using your radio, confirm that the servos are centered before proceeding.

- a) Attach the extension cords to the aileron servos. Secure the plugs together with either string (as shown), tape, or heat-shrink tubing. This will ensure your servos do not come unplugged in flight.



- b) Remove the aileron servo hatches from the bottom of the wing. A standard size heavy-duty servo will fit the plywood mounting brackets on the hatches. Drill pilot holes for the servo mounting screws. Then mount the aileron servos on their hatches using the screws that came with your servos.

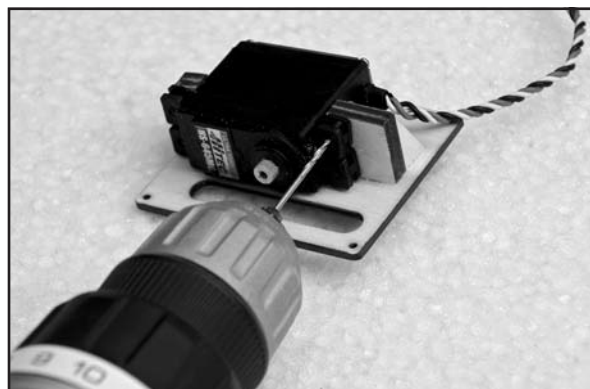

- c) A string is provided in the wing panel for pulling the aileron servo cord through the wing. Each end of the string is taped on the outside of the wing panel. Carefully untape the string at the servo opening and tie the end of the string securely to the end of the servo wire, as shown.



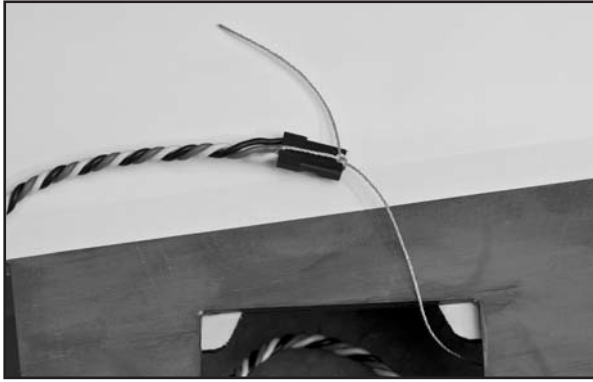

d) Now untape the string at the root end of the wing panel and begin carefully pulling the string and the aileron cord through the wing. You will occasionally feel like the wire has become stuck inside the wing. This is simply the plug on the end of the servo wire hitting the side of one of the holes in the wing ribs. Gently work the string back and forth from both ends until the plug slips through the hole. Sometimes the servo plug comes through all the ribs the first time without getting hung up, and other times it seem like it gets hung up on every rib. Be patient and don't try to force it.



e) Mount the aileron servo and hatch to the wing. Using a 1/16 dia. drill bit, drill pilot holes in the plywood mounting tabs in the wing panel. Use the four holes in the servo hatch as your drilling guide. Four M2.3 x 7mm screws are provided to mount the hatch to the wing.

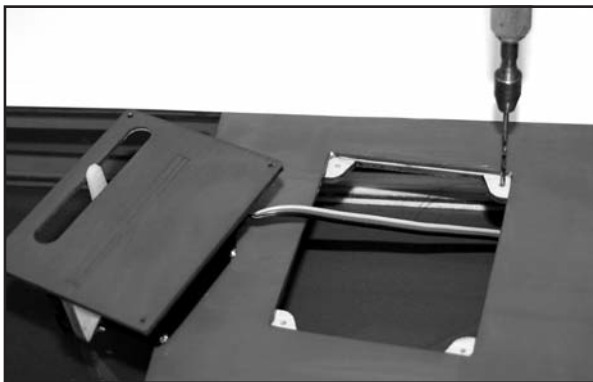

f) Repeat steps c), d), and e) to install the other aileron servo and hatch.

□ 3) Both flap servos need a 6" extension cord in order to exit at the center of the wing. A reversing Y-harness stays plugged into the receiver for the flaps. When the wing is put on the airplane, the flap extension cords are plugged into the Y-harness. Prepare the servos for mounting by installing the rubber grommets and eyelets (supplied with your radio system) in each servo.

a) Attach the extension cords to the flap servos and secure

the plugs together with tape or string.

b) Remove the flap servo hatches from the bottom of the wing. Drill pilot holes for the servo mounting screws. Then mount the flap servos on their hatches using the screws that came with your servos.

c) Insert the flap servo wire and the hatch into the flap servo bay and fish the wire out to the center section (you shouldn't need a string to do this over the short distance). Make sure both the flap and aileron servo wires exit the wing panel through the round servo wire hole in the bottom surface of the wing. It's a good idea to label the servo leads to easily identify the flap from the aileron.

d) Mount the flap servo and hatch to the wing, using four M2.3 x 7mm screws that are provided.

e) Repeat steps c) and d) to install the other flap servo and hatch.

### INSTALLING THE AILERON CONTROL HORNS & PUSHRODS

For the following steps you will need:

- (2) Nylon Control Horns w/ Clamp
- (6) M2 x 30mm Bolts for control horns
- (6) M2 Hex Nuts for control horns
- (2) 4" long Pushrods for ailerons
- (4) Metal Clevis w/ M2.7 thread
- (4) Short pieces of Fuel Tubing

□ 4) At this point connect up your radio system so that you can operate the aileron servos in order to make final adjustments to their neutral position and overall travel.

a) Turn on the radio system and center the aileron trim lever on the transmitter. Check to see if the aileron servo arms are both perfectly centered on each servo. Adjust the arms if necessary.

b) Determine if the servos are moving the correct direction. Correct if needed.

c) Make sure the servo arm does not travel too far and hit the ends of the slot in the hatch. Use the end point adjustment feature of your transmitter to correct this in needed.

□ 5) Install the aileron control horns.

a) First locate the predrilled holes in the aileron. Check to make sure the covering on both sides of the aileron is open over the holes. If needed run a drill bit through the hole to open up both sides.

b) Slide three M2 x 30mm bolts through the control horn and then through the bottom of the aileron. Push or screw them in until they first begin to come through on the other side.

c) Place the nylon clamp piece on the other side of the aileron and feed the bolts through the holes in the clamp.



- d) Secure the control horn and clamp in place with the M2 nuts. Be sure they are tight but do not crush the aileron surface. Apply a small amount of blue Loctite® to the nut and bolt. Repeat these steps to mount a control horn on the other wing panel.

- 6) Assemble and install the aileron pushrods.
  - a) Pre-assemble the pushrods by first placing the small pieces of fuel tubing over the threaded ends of the clevis. Screw a clevis onto both ends of the wire pushrods. Screw the clevis on until it is centered on the threaded portion of the pushrod. This will allow for equal adjustment either way in the next step.



- b) Attach one end of the pushrod to the aileron servo arm. Check that the aileron and the aileron servo are both in neutral position, and then adjust the overall length of the pushrod until the other end of the pushrod can be attached to the control horn.
- c) When finished adjusting the length of the pushrod, tighten the M2 Hex Nut up against the back of each clevis. To insure that the metal clevis can't open up and come loose from the control horn, slide the short piece of fuel tubing over the arms of the clevis. Repeat these steps for the other aileron pushrod.



- 7) This is a good time to refer ahead to the section of this manual titled CONTROL SURFACE TRAVEL and make final adjustments to the operation of the ailerons.

### INSTALLING THE FLAP CONTROL HORNS & PUSHRODS

For the following steps you will need:

- (2) Nylon Control Horns w/ Clamp
- (6) M2 x 30mm Bolts for control horns
- (6) M2 Hex Nuts for control horns
- (2) 3-3/8" long Pushrods for flaps
- (4) Metal Clevis w/ M2.7 thread
- (4) Short pieces of Fuel Tubing

**NOTE:** Unlike the ailerons, the flap servos both need to travel in the same direction. The way we achieved this in our airplane was to use a "reversing" Y-harness to operate both servos in the same direction off of just one receiver port or channel. That is the method described in this manual. However, there are other options that can be used to operate flaps.

Alternate Method #1: You could use a standard Y-harness (more readily available than the reversing type) by simply flipping one of the flap servos over to face the same direction as the other

flap servo. In other words the arms for both flap servos would be on the right (or left) side of the airplane, instead of mirror image like the aileron servos always are. To do this on the RASCAL 110, you would need to also flip one of the flap servo hatches, and adjust the control horn location.

Alternate Method #2: You can eliminate the need for any Y-harness if you have an extra channel available on your computer radio and the two available channels can be "mixed". Plug each flap servo into separate channels, and then program them to move in the same direction.

- 8) Install the nylon control horns for the flaps the same way you did the aileron control horns in step 5.

- 9) At this point connect up your radio system so that you can operate the flap servos. Make sure your transmitter's flap control (knob or switch) is set to the "flap up" position, and then turn on the radio system. The correct position for both flap servo arms when in the flap up position is for the arms to be angled back towards the wing trailing edge approximately 45°. Reposition your flap servo arms if necessary.



With the transmitter set to the "flap down" position, the servo arms should both pull towards the wing leading edge. If your down flap motion moves the servo arms towards the flaps instead of towards the wing leading edge, then you need to reverse the direction of the flap channel in your transmitter.



Activate the transmitter flap control several times to make sure the flap servo arms are in the correct position and the flap servos are both traveling together in the right direction. If all is correct, put the flaps servos in the full up position (servo arms 45° towards the trailing edge) and turn the radio off.

- 10) Assemble and install the flap pushrods like you did the aileron pushrods in step 6.

- 11) This is a good time to refer ahead to the section of this manual titled CONTROL SURFACE TRAVEL and make final adjustments to the operation of the flaps.

*The wings of your RASCAL 110 are now complete and ready to use. Set them aside for now.*



## FUSELAGE ASSEMBLY

### TAIL SURFACE & TAILWHEEL INSTALLATION

In this section the tail surfaces will be mounted on the fuselage. The elevator and rudder servos will also be installed. Because of the size of the airplane, it is much easier to take care of these steps now, before adding the main landing gear.

For the following steps you will need:

- (1) Stabilizer & Elevator assembly
- (1) Fin & Rudder assembly
- (1) Nylon Control Horn with Clamp
- (2) Nylon Control Horns without Clamp
- (6) M2 x 30mm Bolts for control horns
- (6) M2 Hex Nuts for control horns
- (1) 5" long Pushrod for elevator
- (4) Brass Pull-Pull Fittings
- (6) Metal Clevis w/ M2.7 thread
- (6) Short pieces of Fuel Tubing
- (4) Metal Pull-Pull Swage Tubes
- (2) Plastic-coated Steel Pull-Pull Cables
- (1) Tailwheel Assembly
- (3) M3 x 20mm Socket-Head Bolts
- (1) 3-Arm Rudder Horn
- (2) M2.8 x 15mm Screws
- (2) Coil Steering Springs
- (2) Servos with Mounting Screws (not furnished)
- (1) 36" Servo Extension Cord for elevator (not furnished)

□ 12) In preparation to gluing the stabilizer on the fuselage, join the two wing panels together with the aluminum tube wing joiner. Then bolt the wing in place on the fuselage with the nylon wing bolts provided (be sure that the aileron and flap servo wires are inside the fuselage). Set the airplane on a flat surface with enough space around it to easily view it from both the front and rear.

□ 13) Remove the elevator and hinges from the stabilizer and elevator, and set them aside for now. Place the stabilizer onto the fuselage, aligning it with the centerline of the fuselage. Hold it in this position with a weight to be sure it is sitting flat on the fuselage. Step back and check the alignment of the stabilizer to the wing.

- a) First view the model from directly in front. Check to see if the stabilizer is level with the wing, without tilting one way or the other.

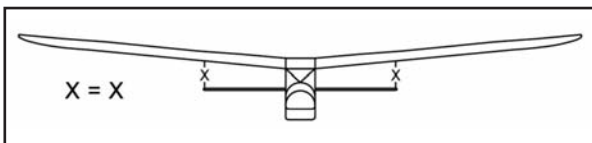

- b) Carefully square the stabilizer to the fuselage and wing in the top view. This is easiest to do by taking measurements from the same point on each side of the airplane.

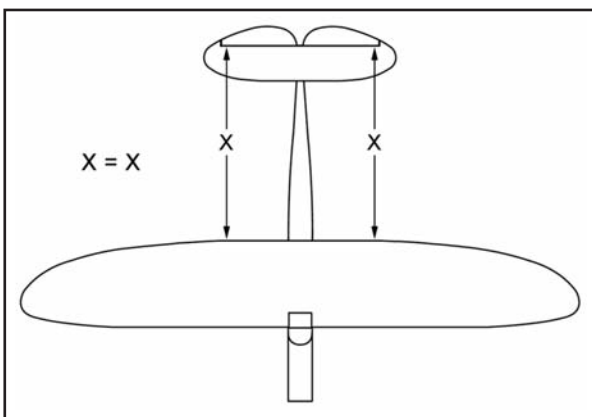

- c) Use a fine line felt tip pen to mark some guide lines on the stabilizer that will make it easy for you to realign the stab after the glue is applied in the next step.

□ 14) The horizontal stabilizer can now be glued permanently onto the rear of the fuselage. We suggest using slow drying epoxy glue for this job to allow time to position the stab accurately and make any final adjustments that might be needed. Apply the glue evenly to the stab saddle at the top rear of the fuselage. Also apply glue to the exposed wood on the bottom center of the stab. Place the stab onto the fuselage, making sure it is properly aligned in top view as well as the front view. Use weights or pins to hold the stab in this aligned position until the epoxy cures. Wipe away any excess epoxy with rubbing alcohol and a soft paper towel. Allow the glue to dry completely.

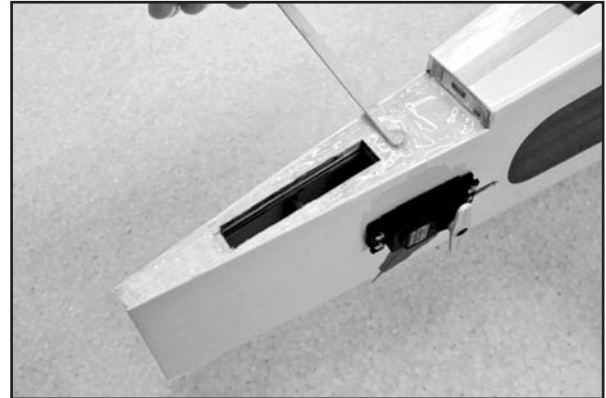

□ 15) While the glue is drying on the stabilizer it is a good time to install the control horn on the elevator, before hinging the elevator to the stab.

- a) The elevator control horn goes on the bottom side of the right elevator. Locate the pre-drilled holes and make sure they are clear all the way through the elevator.
- b) Slide three M2 x 20mm bolts through the control horn and into the bottom of the elevator. Push or screw them in until they first begin to come through on the top side of the elevator.



- c) Hold the nylon clamp piece in place on the top side of the elevator and feed the bolts into the clamp.
- d) Secure the control horn and clamp in place with the M2 nuts. Be sure they are tight but do not crush the balsa surface. Apply a small amount of blue Loctite® to the nut and bolt.

□ 16) After the stabilizer joint is completely dry, glue the fin in place on the fuselage.

- a) Start by pulling the fin and rudder apart. Set the rudder and hinges aside for now. Test fit the fin in place on top of the stabilizer. Check to see that the fin sits flush and perpendicular to the stabilizer. Check the fit of the fin's bottom surface, where it contacts the stab and fuselage. It should contact these surfaces from front to rear. If necessary, trim or sand the bottom of the fin for the best fit.
- b) When satisfied with the fit, glue the fin in place using slow drying epoxy glue. Apply a coat of glue to the bottom of the fin and to the bottom of the vertical fin, including the tab that fits into the top of the stab. Put a coat of glue on the exposed wood on the stab. Press the fin in place into the stab slot and firmly onto the stab and fuselage.
- c) With the fin in place, sight the model from the front to make sure the fin is absolutely 90 degrees upright to the stab, without tilting one way or the other. If needed, use masking tape to hold it in alignment until dry. Wipe off any excess glue rubbing alcohol and a soft paper towel. Let dry.



□ 17) The elevators are now hinged to the horizontal stabilizer. The hinging method is exactly the same as used with the aileron hinges (back in Step 1).



□ 18) Before hinging the rudder to the vertical stab it is best to attach the control horns to the rudder. Locate the pre-drilled holes near the bottom leading edge of the rudder and make sure they are clean all the way through. If needed run a 1/16" drill bit through to clean out the holes. Push three M2 x 20mm

bolts through one of the control horns and then slide the bolts through the 3 holes in the rudder. Slide the other control horn onto the bolts, and then add the three M2 hex nuts. Be sure to tighten the nuts to securely. Do not crush the wood.

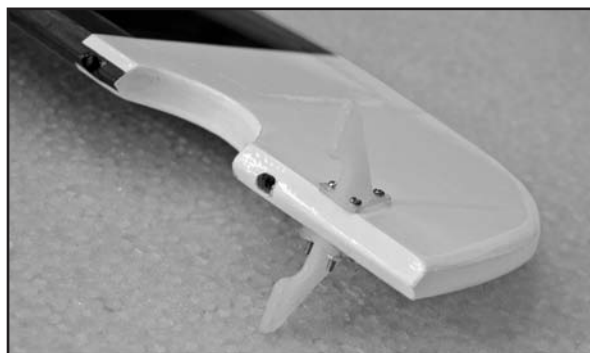

□ 19) Mount the 3-arm Rudder Horn to the bottom of the rudder. Locate the horn on the bottom of the rudder about 1/4" back from the leading edge.

- a) Use a 1/16" drill bit to make pilot holes in the hardwood built into the bottom of the rudder.

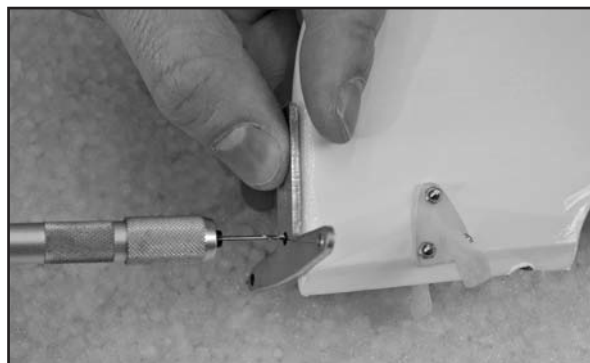

- b) Use the M2.8 x 15mm screws to mount the 3-arm rudder horn to the rudder.



- c) After you mount the horn the first time, take it back off the rudder and reinforce the threads in the rudder with thin CA. Carefully add a few drops of thin CA into each hole. Let dry. This will harden the threads in the wood. Once the CA has dried, screw the rudder horn back in place.



- 20) Hinge the rudder in place.
  - a) First check to make sure all of the holes for all the hinges in the fin and in the rear of the fuselage are clear. You may need to remove the covering from the rear of the fuselage to open the hole for the bottom hinge. Use a sharp razor to cut the covering free.



- b) Using the same method as all the previous, first glue the hinges into the fin and fuselage. Be sure to align the hinges by laying each one over 90°, as shown. This will make sure that all the hinges are in alignment.



- c) Once the glue has dried, apply glue to the holes in the rudder and then carefully slide the rudder onto the hinges. Check for any excess epoxy leaking out around



the hinge points and clean it up with some alcohol and a paper towel. Let the epoxy set, then flex the rudder to make sure the hinges are moving freely.

- 21) Locate the 3 holes at the bottom rear of the fuselage for mounting the tailwheel assembly. Make sure the covering is clear from these holes. Line the tailwheel assembly over the mounting holes and use the M3 x 15 socket-head bolts to secure it to the fuselage. We recommend using some blue thread locker to ensure the bolts do not come loose.

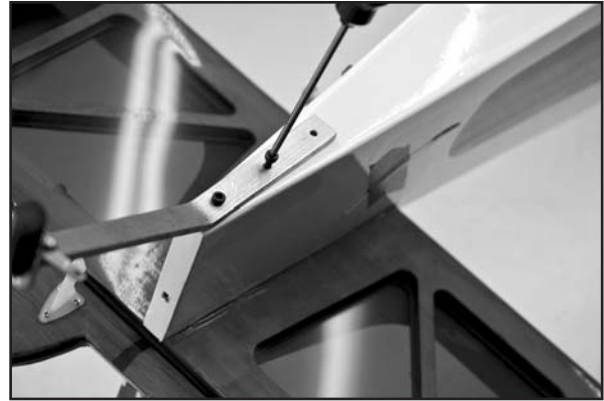

- 22) Install the elevator servo and pushrod.
  - a) Start by attaching a 36" long servo extension cord to a servo. Secure the connectors together with tape, string, or heat-shrink tubing. Insert the servo in the open slot on the right rear side of the fuselage, while feeding the servo cord to the middle of the fuselage. Mount the elevator servo in place using the hardware that came with.
  - b) Locate the 5" long pushrod for the elevator. Slide a short piece of fuel tubing onto the shank of two of the metal clevises. Then screw the clevises halfway onto both ends of the pushrod.



- c) Make sure the elevator servo is centered in neutral position. Also secure the elevators at neutral, perfectly in line with the stabilizer. **Modeler's Tip:** Two long flat sticks (not supplied), one on each side of the fin and rudder, with the ends of the sticks held together with small rubber bands or tape, works good for this.
- d) Attach one end of the pushrod in the outer hole of the elevator servo arm.



- e) Adjust the length of the pushrod until you can clip the other clevis into the elevator control horn.



- f) When finished adjusting the length of the pushrod, tighten the M2 Hex Nut up against the back of each clevis. To insure that the metal clevis can't open up and come loose from the horn, slide the short piece of fuel tubing over the arms of the clevis.

□ 23) Install the rudder servo into the center servo slot of the plywood tray at the back of the cabin area. The servo arm should be towards the front of the tray. Secure the servo to the tray using the hardware supplied with your servo. Center the servo and install a double sided servo arm. We recommend the Du-Bro® "Super Strength" servos arms, with the 1-3/4" double arm for the rudder.



□ 24) At the rear of the fuselage, just in front of the servo cutouts, you will find two oval holes in the frame that need to have the covering cut free. These are the exit holes for the pull-pull cables. Using a razor sharp blade cut out the covering from the oval hole on each side.

□ 25) Locate the pull-pull cables and feed one into each hole from the rear of the fuselage and pull them forward to the servo tray area. Make sure they are clear of any of the support structure inside the fuselage. Tape the loose ends of the two cables to the rear of the fuselage to keep them from falling inside.



□ 26) We will work on the servo ends of the pull-pull cables first.

- a) Run the end of one of the cables through a metal pull-pull swage tube; then through the brass pull-pull fitting; and then back through the swage tube again. Leave about 1/4" outside the swage tube, and about 1/4" between the swage tube and the end of the pull-pull



fitting, as shown. Use an ordinary pliers to crimp the swage tube flat around the cable to secure it in place.

- b) Screw a metal clevis onto the threaded end of the pull-pull fitting. Screw it halfway onto the threads, leaving room for adjusting in both directions. Then clip the clevis into the outside hole on one side of the rudder servo control arm. **NOTE:** Make sure you cross the pull-pull cables over once from the tail to the servo. One cable should go from the right side of the servo arm to the left side of the rudder, and the other cable from the left side of the servo to the right side of the rudder. This gives the cables a straighter run from front to back.

- c) Repeat steps a) and b) to finish the servo end of the other rudder cable.

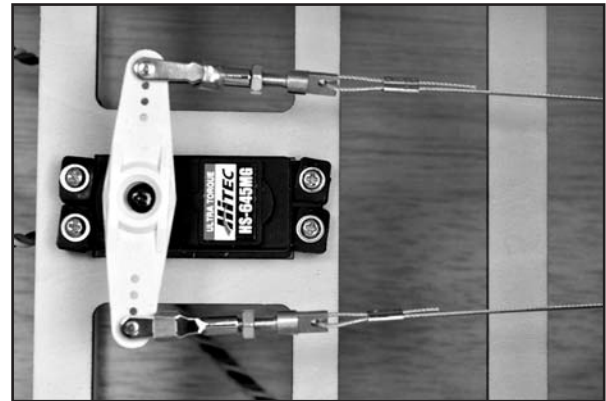

□ 27) Now we will finish the rudder end of the pull-pull cables.

- a) First secure the rudder in neutral position using some flat sticks taped along the sides of both surfaces (see pic). Also make sure the rudder servo is also in neutral centered position.
- b) Slide a short piece of fuel tubing onto the shank of two of metal clevises. Then screw the clevises halfway onto the threaded end of the two remaining brass pull-pull fittings.
- c) Clip one of the clevis/pull-pull fittings into the outside hole of each rudder control horn.
- d) Now secure the rudder in neutral position using some flat sticks taped along the sides of both surfaces (see pic). Also make sure the rudder servo is also in neutral centered position.



- e) Next untape one of the pull-pull cables from the fuselage and pull the cable out so it is tight from the rudder servo arm. Slide the end of the cable through one of the metal swage tubes; then through the hole in the brass pull-pull fitting; then back through the swage tube. Slide the

swage tube so that it is about 1/4" from the pull-pull fitting. Make sure the cable has no slack in it and then crimp the swage tube around the cable using a pliers.



- f) Repeat the last step to complete the cable on the other side of the rudder. Then clip off the excess cables with a wire cutter, leaving about 1/4" sticking out of the swage tube.



- 28) With the rudder still held at center, attach the two coil steering springs.
- Poke one end of the spring through the hole in the 3-arm rudder horn that was attached to the bottom of the rudder.
  - Poke the other end of the spring through the hole in the steering arm on the tailwheel assembly.
  - Center the coil portion of the spring between the two arms.
  - At one end of the spring, loop the tag end of the spring wire back and twist it around itself to secure it.
  - Now go to the other end of the spring and secure it in the same way, pulling just a very slight amount of tension on the spring at when at neutral position.
  - Repeat this for the spring on the other side. If you have equal tension on each side, the tailwheel will be centered when the rudder is centered.



## WINDSHIELD & SIDE WINDOWS

In this section the tail surfaces will be mounted on the fuselage. The elevator and rudder servos will also be installed. Because of the size of the airplane, it is much easier to take care of these steps now, before adding the main landing gear.

For the following steps you will need:

- Clear Plastic Windshield
- M2.3 x 7mm Screws
- Right Plastic Side Window
- Left Plastic Side Window
- Magnets (only for electric power installations)

- 29) Mount the windshield on the fuselage.
- First place the windshield on the fuselage at the front of the cabin. Make sure it is centered and that the sides overlap the cabin frame with equal distance. Tape the windshield temporarily in place.
  - Use a 1/16th drill bit to make pilot holes in the fuselage for the seven M2.3 x 7mm mounting screws, using the pre-drilled holes in the windshield as guides.
  - Remove the windshield from the fuselage. Run a M2.3 x 7mm screw into each hole and remove it. Put a few drops of thin CA into each hole to harden the threads in the wood. Let dry.
  - Mount the windshield on the fuselage with the M2.3 x 7mm screws.



- 30) Now we are going to install the plastic side windows. There are two options for the side windows.

**For Glow or Gas Power Users** - If you are using a gas or glow engine in your RASCAL we recommend that you permanently glue the side windows into the openings in the fuselage using a good brand "canopy glue". Do not use CA glue for this step.

- Test fit the windows first. Note at the front of the window opening that there is a slot in the fuselage structure for

the front window flange. As you install the window, slide the front flange into the slot. You may find that some of the flanges around the window will need to be trimmed a little closer in order to fit nice. A heavy-duty scissors works good for trimming.

- b) Apply a bead of canopy glue around the flange of the window. Press the window into the cutout in the fuse and secure it with tape. Let the glue dry overnight before handling.

**For Electric Power Users** - If you are using an electric motor in your RASCAL, we recommend that you make the side windows removable to provide a way to load and unload your battery pack without removing the wing. The battery pack will go in and out of the fuselage through the open side windows. As you stand (or kneel) in front of the airplane and look down through the windshield, you use one hand in each side window opening to install and plug in the battery packs. In flight, the front of the windshield will be held in place by the front window flange going into the slot in the fuselage. The rear of the window will be held with magnets. The method has worked very well for us.

- a) Test fit the windows first. Note at the front of the window opening that there is a slot in the fuselage structure for the front window flange. As you install the window, slide the front flange into the slot. You may find that some of the flanges around the window will need to be trimmed a little closer in order to fit nice. A heavy-duty scissors works good for trimming.
- b) Eight magnets are provided - four for each side window. Mix up some 5-minute epoxy and glue two of the magnets into the round magnet pockets inside the fuselage at the rear edge of the side window opening. Make sure the magnets are pushed all the way into each pocket. Wipe up any excess epoxy around the edges.

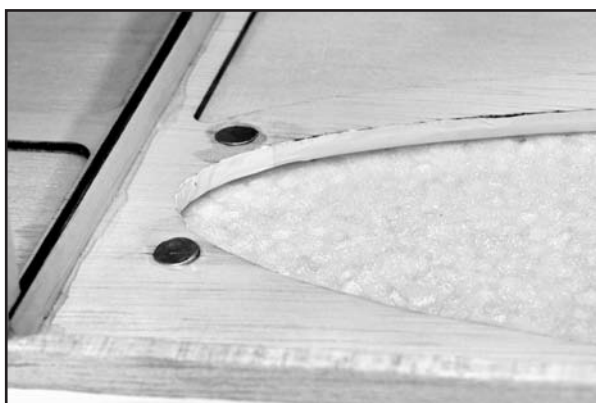

- c) Once the epoxy has dried lay the fuselage on one side. Insert the side window and mark the location of the two magnets on the rear plastic flange of the window with a felt tip pen. Take the window back out and use sandpaper to rough up the plastic frame over where the magnet will be glued. This will help ensure a secure bond to the plastic frame.

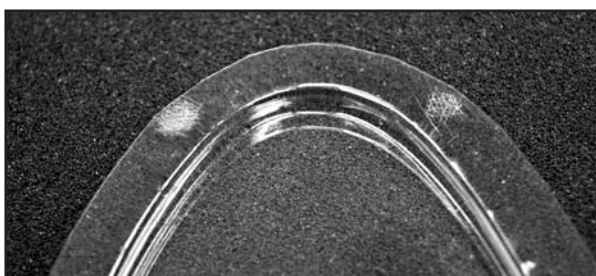

- d) Insert the window back in fuselage. Slip a piece of wax paper in between the window flange and the fuselage side to insure that the window does not get glued to the fuselage. Next, set a magnet on the flange at both locations, testing each magnet's polarity with its mating magnet to make sure they attract each other, instead of repel. Make sure you get the orientation of each magnet correct. Then epoxy the two magnets onto the window flange. Let dry.

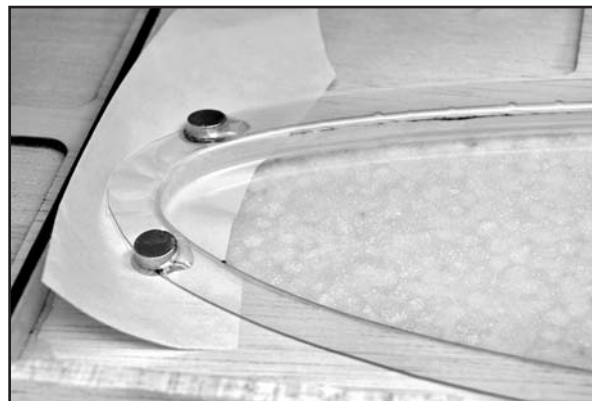

- e) Once the epoxy has dried on the first side, flip the airplane over and repeat the process for the other side window.
- f) The final step in making removable side windows is to provide a way to hold onto the windows when taking them out and putting them back in. We simply made a small "finger grab hole" in each side window as shown. This can be done with a sharp hobby knife or a Dremel® tool with a sanding drum bit. Make the hole large enough to be able to slip your index finger inside the window so you can have a good hold of it.

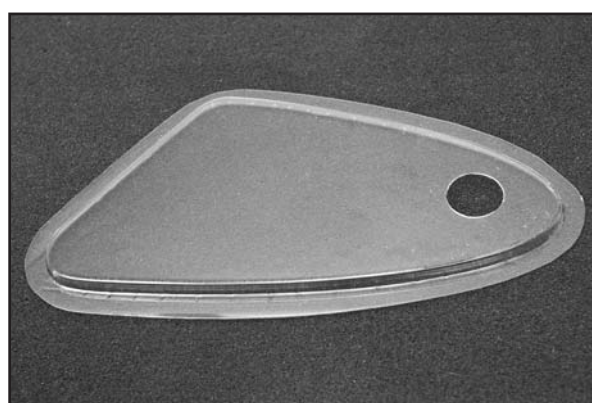

#### LANDING GEAR AND WHEEL PANTS

For the following steps you will need:

- (1) Aluminum Main Landing Gear
- (2) 4" dia. Main Wheels
- (1) Right Fiberglass Wheel Pant
- (1) Left Fiberglass Wheel Pant
- (2) 4 mm dia. Threaded Axles
- (2) 7.6 mm Hex Nuts; for axles
- (4) 4 mm ID Wheels Collars; for axles
- (4) M3 x 12mm Socket-Head Bolts
- (4) M4 x 20mm Socket-Head Bolts
- (4) M4 Split-Ring Lock Washers

**NOTE:** We suggest you use a thread locking liquid (like Loctite®) on all bolts and nuts used in the assembly of the landing gear.



❑ 31) Install an axle in the bottom holes of the Aluminum Main Landing Gear. Secure the axle with the 7.6mm Hex Nut. When tightening the nut, keep the flats of the hex head of the axle (on the side where the wheel pant will mount) parallel to the front edge of the leg - see photo. This allows the hex head to fit inside the notch in the wheel pants, when they are added later.

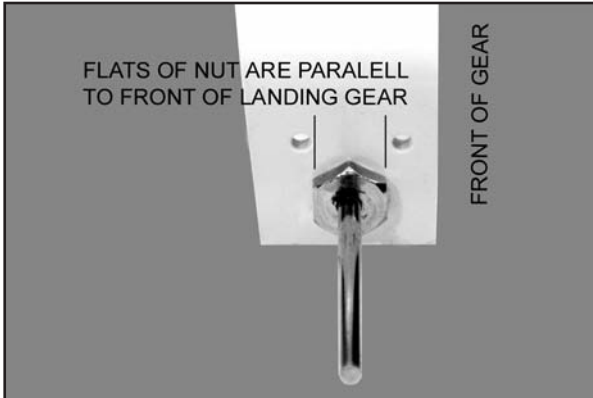

❑ 32) Slide a 4mm wheel collar onto the axle shaft. Leave about a 3/8" gap between the wheel collar and the axle nut, to provide proper spacing of the wheel in the wheel pant. Orient the wheel collar so the set screw is pointing towards the bottom of the landing gear. Tighten the wheel collar set screw securely.

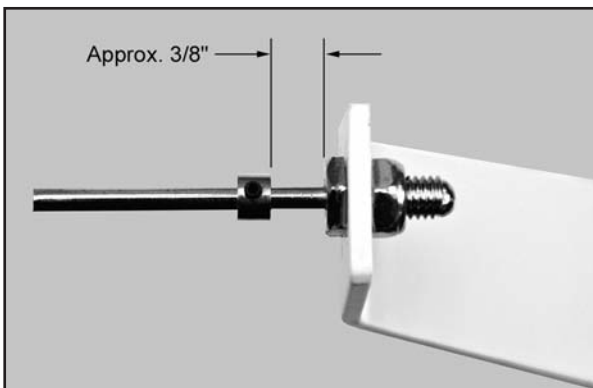

❑ 33) Slide one of the 4" main wheels onto the axle. Make sure that the wheel spins freely. Then slide a second wheel collar onto the axle and up to the wheel. Leave just enough gap so the wheel spins freely. Orient the wheel collar so the set screw is pointing towards the bottom of the landing gear, and then tighten the set screw.

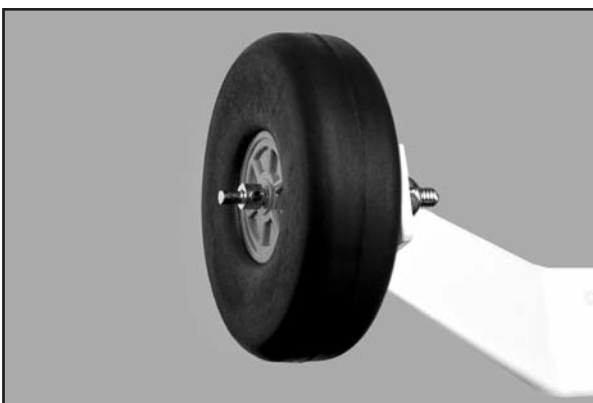

Check the orientation of the landing gear to make sure you know which way is forward. In side view, the leading edge (or front) of the landing gear is straight, while the trailing edge (or rear) is slightly angled. Be sure to mount the landing gear and the wheel pants in the correct direction in the next steps!

❑ 34) Set the wheel pant in place over the wheel, and line it up with the mounting holes in the aluminum landing gear. Using two M3 x 12mm socket-head bolts to fasten the wheel pant to the gear.

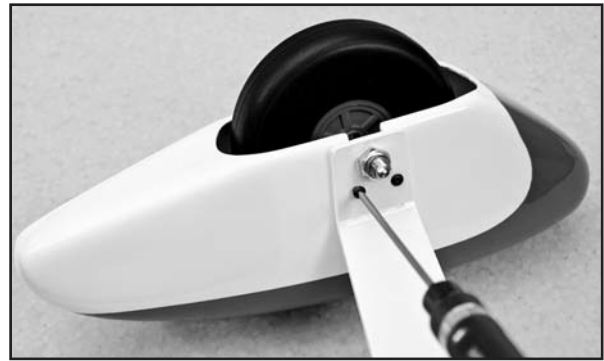

❑ 35) Attach the landing gear to the bottom of the fuselage using four M4 x 20mm Socket-Head Bolts and four M4 Split-Ring Lock Washers. Tighten these four mounting bolts firmly in place.



## GLOW and GAS ENGINE INSTALLATION

*Skip this section if you're using an electric motor.*

As mentioned in the front of this manual, due to the wide variety and configuration of different brand glow and gas engines, and their different engine mount and fuel tank requirements, we have not included any engine mount or fuel tank in this kit. Rather than put in an engine mount and fuel tank that most of you won't be able to use, we are leaving it up to you to supply your own to fit your particular engine.

❑ 36) When mounting your engine keep in mind the following design parameters.

The fuselage has been built with the correct right and down thrust already incorporated into the firewall.

- These are: 2° Right Thrust
- 2.5° Down Thrust

The firewall has been laser etched with the location of the true vertical and horizontal thrust lines, for placement of your engine mounts. Note that the vertical thrust is off-center to the left, allowing for the built-in right thrust. The horizontal thrust line is offset slightly high, to allow for the down thrust. Be sure to center your engine at these locators in order for the cowling to fit properly. Using a straight edge and sharp pencil, extend the horizontal and vertical thrust lines to the edges of the firewall.

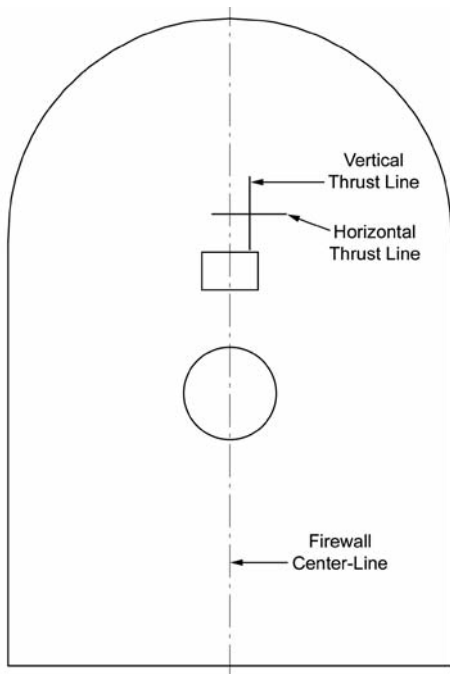

The design distance from the front of the firewall to the back of the prop is 6 inches. Mount your engine accordingly in order for the cowling to fit properly.

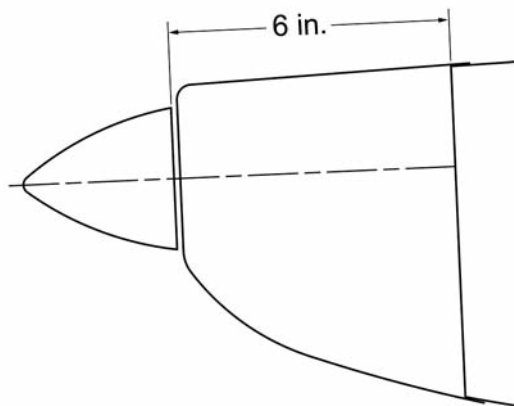

For reference, here are some photos of typical glow and gas engine installations.

**SAITO 1.50 SINGLE-CYLINDER 4-STROKE ENGINE**

Engine is mounted on common universal style twin beam engine mounts. Simple throttle hookup via flex-cable pushrod assembly. Bottom of cowling is opened up for engine head to stick out and for cooling.

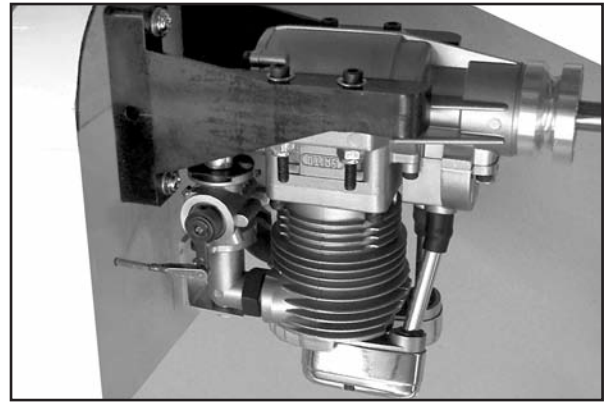
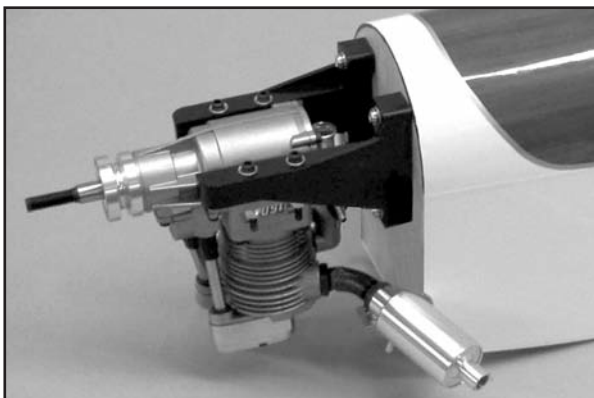

**O.S. GEMINI 1.60 TWIN-CYLINDER 4-STROKE ENGINE**

The cowling is split into two pieces along the horizontal thrust line. Note hardwood mounting blocks epoxied along edge of lower cowl, for top cowl mounting screws. This engine came with an engine mount. Plywood spacers are used between the engine mount and the firewall to provide the design 6 in. distance between prop washer and firewall.

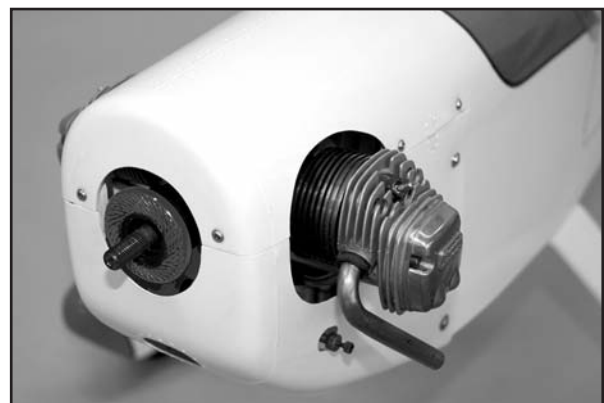
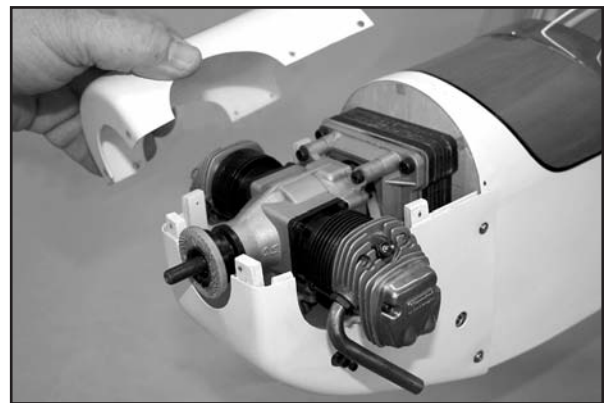



### F.P.E. 1.3 (21cc) SINGLE-CYLINDER GAS ENGINE

This gasoline engine has its own integral mount. Plywood spacers are required to achieve the design distance of 6 in. from the firewall to the prop washer. Carburetor sticks out of right side of cowling. Bottom of cowling opened up for cylinder head and good cooling.

First Place Engines - [www.fpengines.com](http://www.fpengines.com)

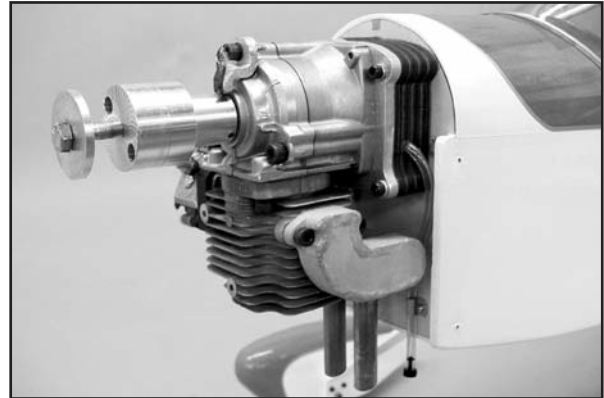

### SYSSA 30cc GAS ENGINE

The SYSSA 30 is a popular gasoline engine for the RASCAL because it does not stick out the sides of the cowling. Pillar mount can be customized to provide the 6 in. distance from the firewall to the prop washer. Bottom of cowling is opened up for cylinder head and exhaust pipes.

Syssa Aircraft Performance - [www.syssaaircraft.net](http://www.syssaaircraft.net)

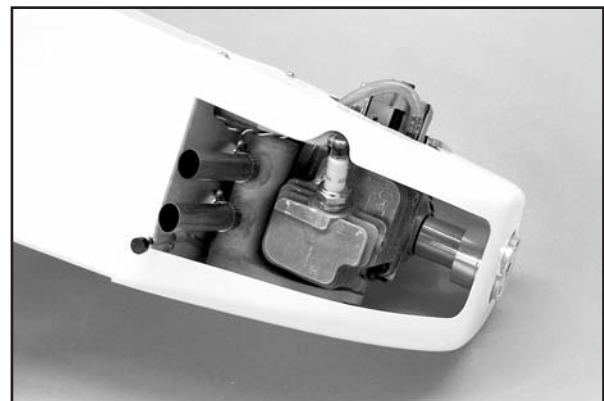
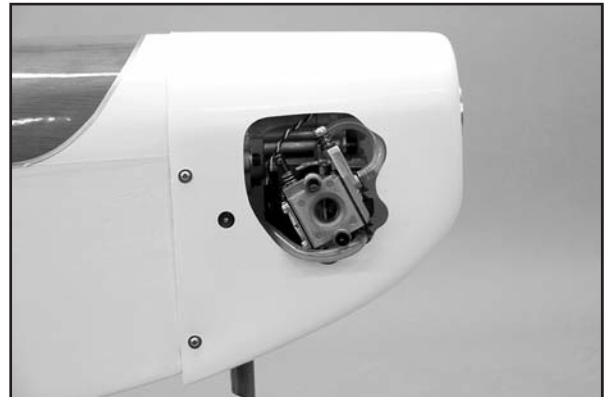
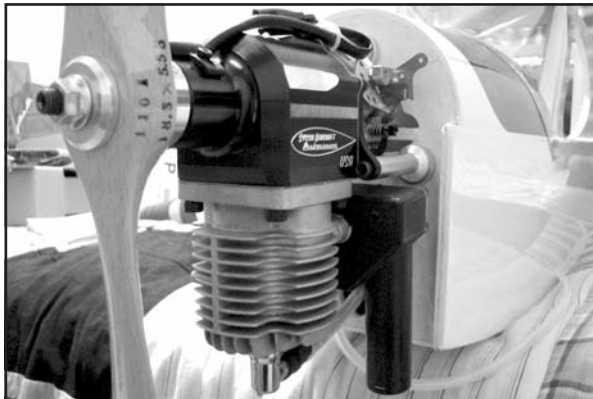

## ELECTRIC MOTOR INSTALLATION

*Skip this section if your using a glow or gas engine.*

This kit does include a laser-cut plywood universal motor mount that will work for almost all brushless motors that will likely be used in the RASCAL 110. For that reason, we will go through step-by-step instructions on how to use the included mount. The mount assumes that your brushless electric motor includes a typical "X" or "cross" style mounting plate on the back of the motor.

For the following steps you will need:

- (1) Fiberglass Cowling
- (6) M3 x 10mm Screws



- (1) Plywood Electric Motor Mount
- (1) Balsa Triangle Stock
- (4) M4 x 25mm Socket-Head Bolts
- (4) M4 x 20mm Socket-Head Bolts
- (4) M4 Blind Nuts
- (4) M4 Flat Washers
- (4) M4 Lock Washers
- (2) Velcro® Straps
- (1) Electric Motor, ESC, Prop, Lipo Battery (not furnished)

□ 37) Note that the firewall portion of the laser-cut plywood motor mount is adjustable fore and aft to accommodate different length motors. In this step, we will adjust the motor mount for your particular electric motor. For the RASCAL 110, we need a total distance from the back of the plywood motor mount box to the motor's thrust washer to end up exactly 6". This distance allows the cowling to fit properly.

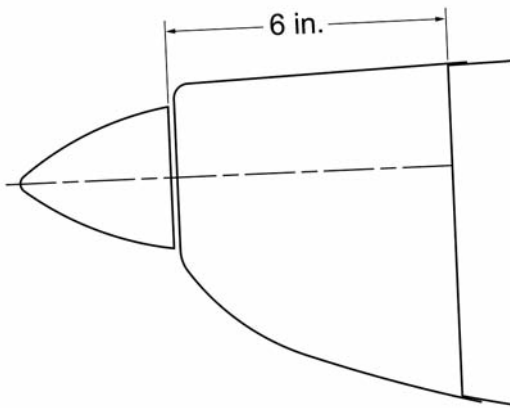

- a) Assemble your motor according to the manufacturer's instructions. Then carefully measure the distance from the back of the mounting plate to the front of the thrust washer (the "thrust washer" is where the back of the propeller will be located).

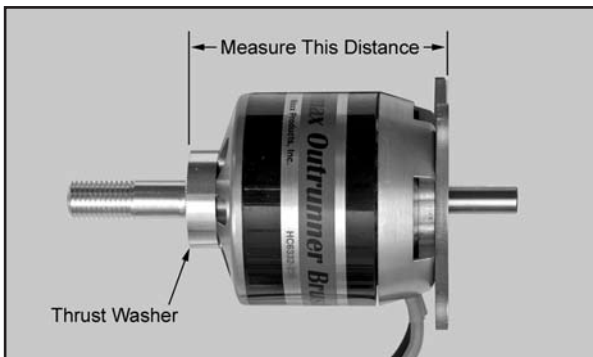

- b) Subtract the measurement taken in the previous step a) from 6". The result is the distance you need to locate the front of the firewall from the back of the plywood motor mount box. (With the motor we are using in these photos, the motor measurement is exactly 3". So 6"

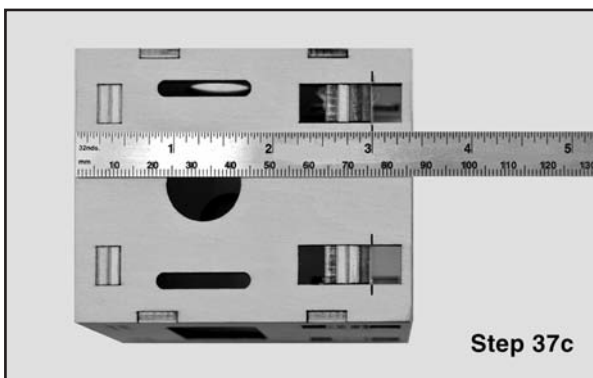

*minus 3" = 3". We will set our firewall at 3" from the back of the mount. Your result may be different depending on your motor.)*

- c) Carefully measure and mark the distance determined in the previous step from the back edge of the motor mount box towards the front. Do this along side each of the adjustment slots on both sides of the box.
- d) After you have all the slots marked, move the firewall until you have the front of the firewall lined up with the marks. Make sure you end up with the firewall straight and square in the box. If it is not, recheck your marks and adjust as necessary.
- e) Tack glue the firewall in place. Recheck once more to make sure that the front of the firewall is at the correct distance from the back of the motor mount box. That distance plus the length of your motor must equal 6". When satisfied it is correct, glue the firewall securely to the rest of the motor mount box. Make sure to soak in some CA along all the edges.



□ 38) A set of four M4 x 25mm socket-head bolts, M4 blind nuts, and M4 flat washers are provided for attaching the plywood electric motor mount to the firewall. The firewall has been laser etched with the four locations for mounting bolts. Look closely and you will find four small etched dots on the firewall with the correct spacing to match the holes in the back of the plywood motor mount.

- a) Using a 1/16" drill pilot holes through the firewall at the four etched locations. Then switch to a 1/4" dia. bit to drill out the four holes to the final size to accept the blind nuts.



- b) Install the M4 blind nuts in the back of the firewall. You will need to reach in through the fuselage to the front of the plane. This can be made a lot easier by inserting a 1/8" dia. dowel (7" to 8" long) through the hole from the

firewall side. When you can see the end of the dowel in the fuselage, slip one of the blind nuts onto it, and then pull the dowel back out of the hole while holding the nut on the dowel from the inside. This will locate the blind nut to the backside of the hole every time.

Once you have the blind nut started in the hole, hold it in position from the inside with one hand while you remove the dowel and start one of the M4 bolts into the blind nut with the other hand (or enlist a helper). Tighten the bolt to pull the blind nut into final position. Be sure to use a flat washer under the bolt head to prevent the bolt from sinking into the face of the firewall.

If desired, the blind mounting nuts can be permanently adhered to the backside of the firewall by using a little 5-minute epoxy on your finger to spread the glue around the outside edges of each blind nut. Do not get glue in the threads of the blind nut.

- c) Place the X mount, that came with your brushless motor, on the front of the plywood motor mount. Center it using the etched lines on the front as your guide. Mark the locations of the four mounting holes.

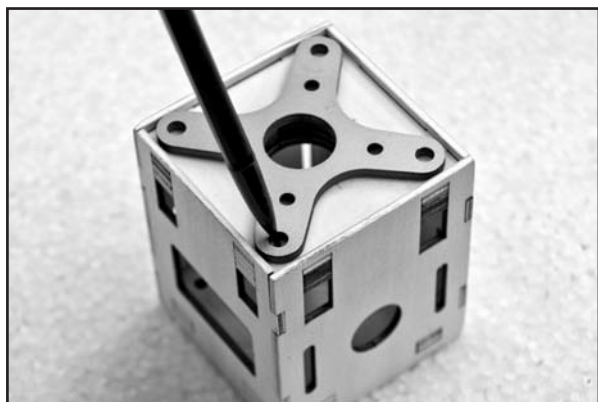

- d) Drill out the four holes for the X mount, first using a 1/16" dia. drill bit as a pilot, followed by a 1/4" bit. Then install an M4 blind nut in each of the four holes, on the back side of the firewall.

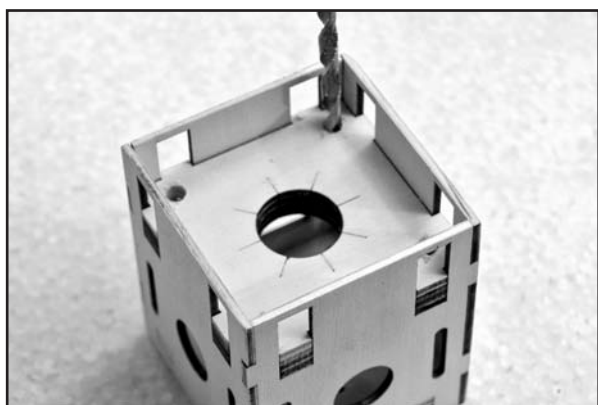

- e) A long piece of balsa triangle stock is provided to reinforce the motor mount. Measure, cut and glue pieces of triangle stock in all the corner joints inside the motor mount box. Make sure to soak in plenty of CA to make a strong joint.
- f) Mount the plywood motor mount onto the fuselage with four M4 x 25 bolts and M4 flat washers. You can access the head of the bolts through the slots in the side of the mount using a ball-end hex wrench or driver, as shown.

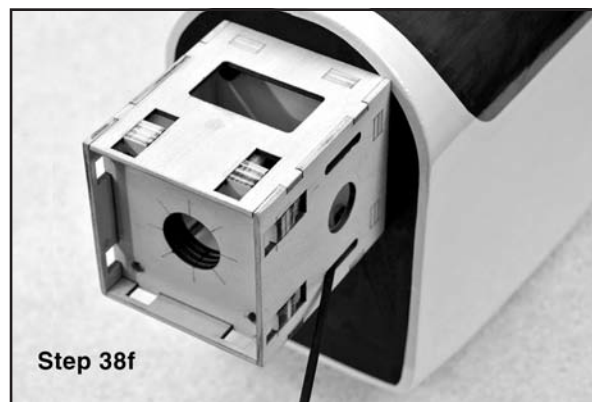
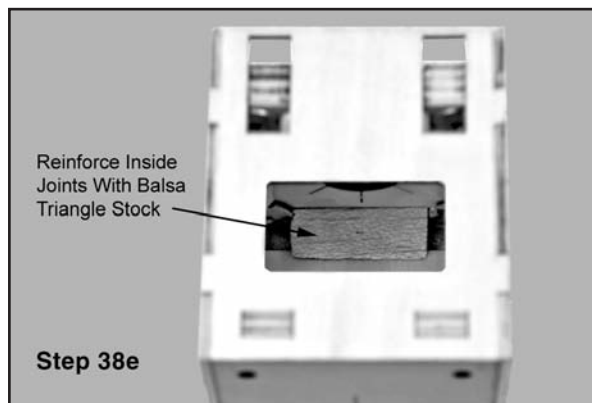

- 39) A set of four M4 x 20mm socket-head bolts and M4 lock washers are provided to mount your motor to the motor mount. Check to make sure your motor wires are not coming out the top of the mount when the motor is secured or they will interfere with the cowling. We found it best to route the wires out the bottom of the mount. Use blue thread locker on the bolts to ensure they do not come loose.

- 40) Connect the three motor wires of your Electronic Speed Control (ESC) to the motor. Mount the ESC to the bottom or sides of the plywood electric motor mount. Plastic cinch straps are very handy for this, and for securing loose wires to structure. Also route the ESC's servo wire back to your receiver and plug it in.

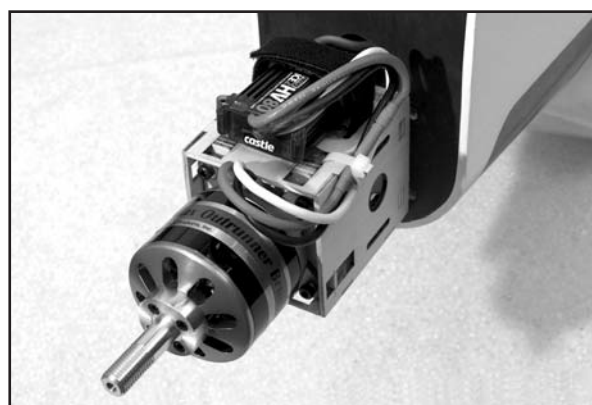

- 41) A laser-cut plywood removable battery tray is included for mounting the batteries in the airplane. Use two Velcro® straps to secure your batteries to the tray and then install it into the airplane. The tab at the front of the tray locks into a slot at the front of the fuselage, and the rear end of the tray is held in place with a M4 x 20mm nylon bolt. The tray with batteries will fit into the airplane through the side windows. Optional: In addition to the two straps, it is a good idea to use hook-&-loop tape (not furnished) on the bottom of your battery pack and on the top surface of the plywood battery tray, to make sure the battery pack will not move around during aerobatics.

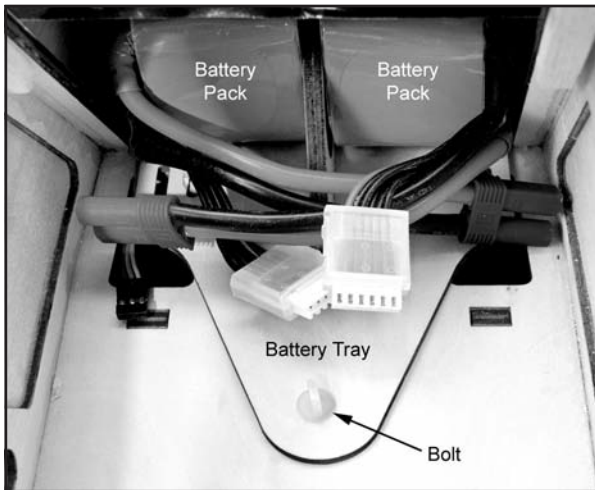
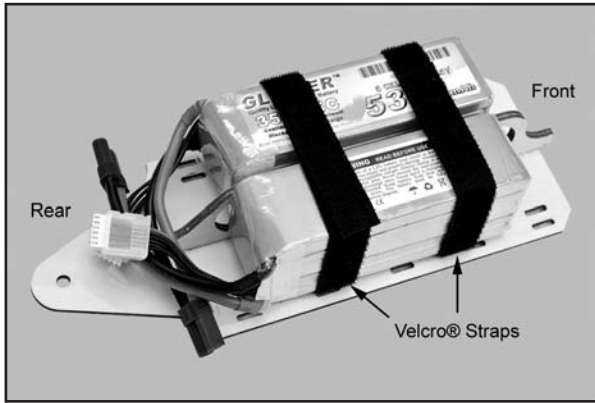

- 42) Now is a good time to operate the motor and check the direction of rotation. Do not do this with a propeller attached to the motor! If you need to reverse the rotation, swap two of the leads to the brushless motor and recheck the rotation.

### MOUNT THE COWLING

*Both glow, gas, and electric motor users resume assembly here.*

- 43) Mount the cowling on the fuselage with four M3 x 10mm Screws. Notice that the holes for the four cowl mounting screws are already pre-drilled in the cowling - two on each side.
  - a) First test fit the cowling on the fuselage. Make sure you have adequate clearance between the front of the cowl and the back of the propeller, and that the prop shaft is centered in the hole. Use low tack tape to hold the cowling in place for the next step.
  - b) Use a 5/64" or #45 bit to drill a pilot hole for the top left cowl mounting screw. Center the drill in the hole in the cowling and drill into the fuselage side. Install an M3 x 10mm screw in the pilot hole - do not over-tighten the screw.



- c) Recheck the position of the cowling and make any adjustments needed to get it back in position.
- d) Now drill another pilot hole for the upper screw on the other side of the cowling. Install the screw.
- e) Repeat this process to install the two bottom cowl mounting screws. Remove all the tape.
- f) Remove the cowling from the fuselage and set it aside. Harden the cowl mount holes in the fuselage by putting 2-3 drops of thin CA into each hole. This will harden the threads. When you are sure the glue is dry you can remount the cowling.

### COOLING IS IMPORTANT

Regardless of what type of power system you are using (glow, gas, or electric), it is very important to make sure you have plenty of cooling air going into and out of the cowling. While letting cooling air into the cowling is vitally important, it is always recommended to have more air exit area than inlet area to create a positive air flow through the cowling. This creates an actual suction effect, drawing the heated air out of the cowling so that more cool air can come in. This positive air flow keeps your motor running cool. Note that there is a generous sized cutout at the bottom rear edge of the cowling for air exit.

You may choose to make some additional holes in your cowling to ensure proper airflow. Perhaps an opening at the front of the cowl in front of the motor or cylinder head will be needed. Or in the case of electric motors you sometimes see slots in the top of the cowl right over the motor. This will draw air in from the top and pull it down over the motor and ESC.

A Dremel® Tool with an assortment of bits is without a doubt the best tool to use for making cutout in the fiberglass cowling. However, if you do not have access to such a tool, you can cut the opening with a drill, a hobby knife, and a sanding block. First first drill a series of almost touching 1/8" holes inside the pattern lines; then use the knife to cut through the connecting material between each hole; and finally finish the edges of the opening with the file or a sanding block.

### COMPLETE THE RADIO INSTALLATION

If using a receiver battery pack the on/off switch can be mounted on the outside of the fuselage, using the switch mounting hardware that came with your system. There are holes for either a standard switch or a multi switch/charge block already pre-cut in the fuselage sides, underneath the covering material.

Decide where you are going to mount your receiver, and secure it to the structure. If using a gas or glow engine be sure to wrap the receiver in soft protective foam, held in place with tape or rubber bands.

Connect all the servo leads to the appropriate channels in the receiver, including the aileron "Y" harness and the switch connector if applicable. Test the radio system to make sure everything works correctly. The twin cable ends of the aileron Y-harness (or dual aileron servo extension cords if using that method) must be accessible from the top of the cabin.. We placed our receiver on the floor of the fuselage between the servo tray and the battery/fuel tank bay.

Be sure to follow your radio manufacturer's recommendations on routing your receiver antenna.



## WING STRUTS

The wing struts on the RASCAL 110 are functional, and the airplane should never be flown without the struts in place. The struts mount to the wing and fuselage with M4 x 20mm socket-head bolts. A metric 2.5mm ball driver is the best tool to have for installation and removal. Do not be tempted to use an S.A.E. 3/32" hex driver. This tool will eventually roach out the bolt heads.

The wing struts are factory painted and already set-up to mate with the appropriate blind mounting nuts that are pre-installed in the fuselage sides and in the bottom surfaces of both wing panels. There is a left and a right wing strut - note the airfoil shape of each strut.

Assemble the two wing panels together, and then bolt the wing on the fuselage with the M6.5 x 45 mm nylon wing bolts. Hold the strut in place against the fuselage side and bottom of the wing panel and install the bolts, starting the threads with your fingers. Tighten the bolts in place firmly with a hex driver.



### CONGRATULATIONS!

Your RASCAL 110 is completely assembled. However, it is NOT ready for flight! There are a few very critical pre-flight tasks we must perform before flying. These are extremely important and should be approached with patience and care.

## PRE-FLIGHT

### BALANCE

This may be the single most important step in preparing your airplane for flight. All airplanes, model or full-size, must be accurately balanced in order to fly successfully. An airplane that is not properly balanced will be unstable and will most likely crash.

**Preliminary:** All the parts and components, that will be in the airplane in flight, must be installed in their correct positions. This includes all the radio gear, the propeller, spinner, muffler (if applicable), etc. Every piece of essential equipment must be installed, ready for flight. Always balance a glow or gas powered model with the fuel tank empty. Always balance an electric powered model with the battery pack in place.

### RECOMMENDED STARTING BALANCE POINT 4-1/2" Behind The Leading Edge Of The Wing

The recommended starting balance point for the RASCAL 110 EG ARF, is located 4-1/2" behind the leading edge of the wing,

immediately next to the fuselage side. This is the location of the main wing spars. We've flown this airplane with the C.G. location as far back as 5" without any trouble. However, moving the C.G. further back tends to make the elevators more sensitive and will also accelerate the stall.

Because of its large size, balancing the RASCAL 110 using a typical balancing fixture may not be practical. However, you can get acceptably accurate results by first placing a piece of tape, temporarily, on each side of the fuselage, just beneath the wing, at the 4-1/2" location. Then, simply use your fingers beneath each wing panel to pick the model up at the C.G. location. Another method is for you and a friend to pick the model up at the wingtips, at the main spar location.

The goal is to get the airplane to balance perfectly level at the desired C.G. point. Level means level - not nose down or tail down - level! If the nose hangs down, the model is nose heavy. Likewise, if the airplane hangs tail down, it is tail heavy. If either of these conditions exist with your model, they must be corrected.

### CONTROL SURFACE TRAVEL

Double check the alignment and movement of all the controls one more time! Adjust all of your pushrod linkages so that the control surfaces are in their neutral position when the transmitter sticks and trim levers are centered. Make sure the control surfaces move in the proper direction when you move the sticks. You'd be amazed to know how many models have been destroyed on takeoff with one of the controls reversed. Don't let it happen to you! In fact, it's a good idea to get into the habit of checking for proper control response every time you get ready to fly.

Adjust your pushrod linkages and/or transmitter EPA (End Point Adjustment) settings as necessary to provide the recommended amount of control surface travel. NOTE: The rudder measurement is taken from the bottom of the rudder, at its widest point.

The following Low Rate control surface movements will provide your RASCAL 110 EG ARF with smooth, predictable flight characteristics. We suggest that you start with these Low Rate movements and adjust them later to suit your style of flying. Note that the rudder and elevator measurements are taken from the widest part of the surface at the trailing edge. The aileron measurements are taken at the inboard trailing edge. We have also provided the High Rate settings that we use with our RASCAL models. As you become familiar with flying your RASCAL, these settings can be adjusted to suit your flying style.

### RECOMMENDED CONTROL SURFACE TRAVEL

**AILERONS - LOW RATE: 1-1/16" UP - 1-1/16" DOWN  
HIGH RATE: 1-3/8" UP - 1-3/8" DOWN**  
**ELEVATOR - LOW RATE: 1-3/16" UP - 1-3/16" DOWN  
HIGH RATE: 1-5/8" UP - 1-5/8" DOWN**  
**RUDDER - LOW RATE: 1-3/4" LEFT - 1-3/4" RIGHT  
HIGH RATE: SAME**

### RECOMMENDED FLAP SETTINGS

**FULL FLAP: 2" down travel with 20% down elevator mix**  
**HALF FLAP: 1" down travel with 11% down elevator mix**

Make sure that both flaps travel evenly up and down at the same rate and stop at the same position.



Flaps in full down position. It is common practice to mix in a small amount of down elevator as the flaps come down, to eliminate any tendency for the airplane to balloon up.

## FLYING

If you've carefully followed these assembly instructions, test flying your new RASCAL 110 should be a lot of fun! You will find that the RASCAL 110 is a very smooth flying airplane. The surface movements given in this manual should provide the airplane with smooth, positive control in pitch, roll, and yaw. We found this to be true at virtually any speed that we flew the airplane. The controls will remain effective down to virtually zero airspeed. We have found that coordinated turns - using both ailerons and rudder - aren't necessary with this airplane. The ailerons are effective and get the airplane around just fine. However, using a little rudder in the turns is also very effective and tends to bring the airplane around even quicker.

Make it a routine part of your pre-flight procedures to check each control on the airplane, making sure each flight surface moves in the correct direction. Also, check each control linkage to be sure they are secure and that nothing is loose. Next, make a routine range check with your radio system to be sure that it is working perfectly. We always suggest that this same range check be made when the engine is running. This is especially true if your airplane is powered with a gasoline engine. Gas engines can often produce extraneous RF (radio frequency) "noise" while running. RF noise can interfere with the radio system, causing servos to "glitch". If this occurs with your model, take steps to eliminate the problem before trying to fly the airplane.



Electric power Rascal 110 making a smooth scale style takeoff.

When you're satisfied that the airplane is ready for flight, start the engine and allow it to warm-up to operating temperature. Holding up elevator, taxi the RASCAL out to the take-off position on the flying field. For take-off, the airplane should be lined-up with the center of the runway, with the nose pointed directly into the wind. Hold a little up elevator and smoothly advance the throttle - do not slam the throttle full open all at once. As the

airplane begins moving forward, gradually back off of the up elevator input, using the rudder, only sparingly, to correct any engine torque and/or wind induced deviations from a straight take-off run. Allow the tail to come up and the airplane to gather speed on the main wheels. Lift-off will happen shortly. Keep the wings level with the ailerons and climb out at a shallow angle to a reasonable trim altitude. At altitude, make any necessary trim adjustments to achieve straight and level flight.



A high performance takeoff style.



Climbing out.

First, try a simple loop from level flight. You should see the airplane track cleanly through the loop with no tendency to "twist out" at the top.

While still at altitude, fly the airplane into the wind and throttle the engine back to idle. Keep the airplane level with the ailerons and hold the nose up with elevator input. Watch carefully to observe the stall characteristics of the model. Our RASCAL 110 models have all exhibited a consistently gentle stall, with the wings barely rocking in pre-stall, followed by the nose dropping just a little before the airplane almost immediately resumed controlled flight. This exercise tells you a lot about how slow you can fly the airplane during a landing approach.



The Rascal 110 has gentle straight ahead stall characteristics.

The RASCAL 110 was never intended to be an IMAC capable model but it can perform a surprising number of maneuvers, and it does them all in majestic style. With the controls set at

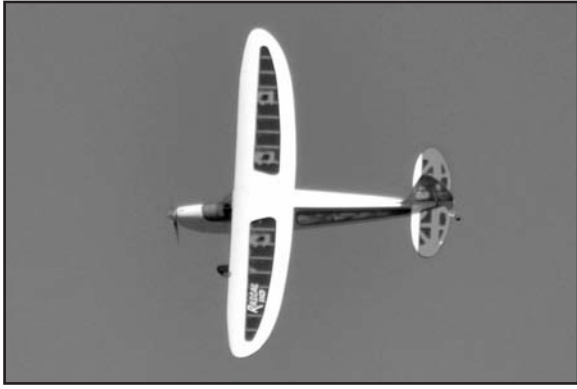

the recommended starting point, rolls will be slow, especially so with engines at the lower end of the recommended range. However, with a little practice rolls can become axial, smooth, and almost elegant. Inverted flight is easy and we've found that it takes very little down elevator input to hold it in level flight. We've learned to snap roll the RASCAL 110 very effectively by entering the snap at quarter-throttle or more. It's amazing to see 9+ feet of wing move that quickly! Likewise, we've learned to enter a spin, again using a quarter-throttle or better entry. The airplane enters a spin very nicely and will instantly stop rotating when the controls are released. We make both the snap roll and spin entries using hard rudder, up elevator, and hard-over ailerons.

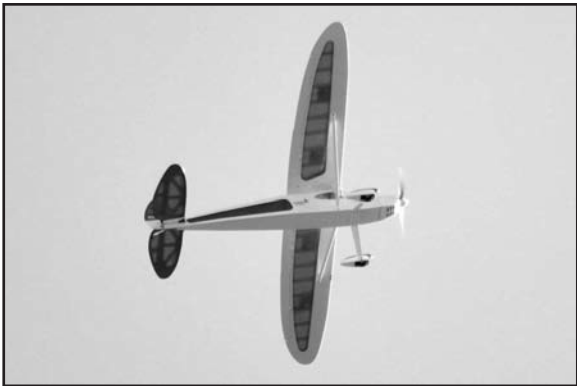

Like all of the SIG RASCAL models, the rudder is exceptionally powerful on the RASCAL 110. You'll find that cross control maneuvers such as side slips, knife-edge flight, flat turns, etc. - are a lot of fun with this airplane. If you're flying from a short field or a field with trees and need to get the airplane down at a higher angle than the normal approach sink rate, try side slipping it into the field. The RASCAL 110 can be side slipped (cross-controlled ailerons and rudder) at very high angles of decent, at surprisingly low speeds.

Landing the RASCAL 110 is a pleasure. No matter what your level of R/C expertise is, understand that the RASCAL 110 wing



A Rascal landing with an onboard camera mounted on top of the wing. The Rascal 110 is a versatile workhorse and can be used for aerotowing gliders, parachute and candy drops, banner towing, and just about any other load carrying task.

is 1522 square inches in area and this amount of square footage is going to want to stay flying! Therefore, your landing approach should take into account the airplane's impressive glide ratio. The flaps have been added to the design to help curb the floating. With practice and becoming accustomed to the glide of this airplane, you'll soon be landing at very low speeds, putting the airplane wherever you want it on the runway - either with or without using the flaps.



Here is another Rascal 110 with an onboard camera, this time mounted on the bottom between the landing gear legs.

In all of this, we're willing to bet that you'll never tire of those long, slow, low altitude fly-bys and touch- and-go landings. What a super looking and flying airplane!



We sincerely hope that your RASCAL 110 ARF will provide you with many, many enjoyable flights for many flying seasons to come. We also hope that this has been an enjoyable kit for you to assemble and fly. Please always operate your airplane in a safe, responsible manner with constant regard to other flyers, spectators, and property.

Good luck and safe flying!

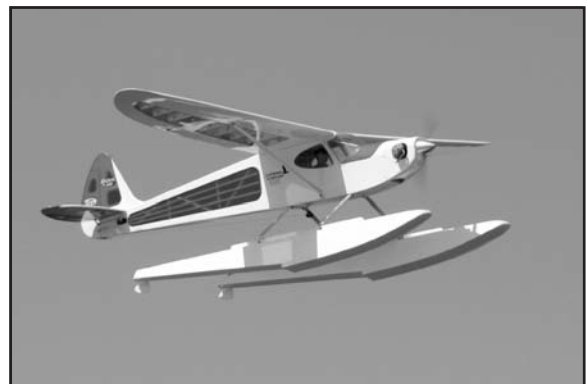

With its light wing loading and terrific flight performance the Rascal 110 makes a great float plane. This one uses an O.S. Gemini Twin 1.60 4-stroke for power. Floats approximately 56-60 inches long are recommended for the Rascal 110.



## CUSTOMER SERVICE

SIG MFG. CO., INC. is committed to your success in both assembling and flying the KADET SENIOR SPORT ARF. Should you encounter any problem building this kit or discover any missing or damaged parts, please feel free to contact us by mail or telephone.

**SIG MFG. CO., INC.**  
**P.O. Box 520**  
**401 South Front Street**  
**Montezuma, IA 50171-0520 USA**

**PHONE: 1-641-623-5154**  
**FAX: 1-641-623-3922**

**SIG WEB SITE: [www.sigmf.com](http://www.sigmf.com)**  
**SIG E-MAIL: [mail@sigmf.com](mailto:mail@sigmf.com)**

## LIMIT OF LIABILITY

The craftsmanship, attention to detail and actions of the builder/flyer of this model airplane kit will ultimately determine the airworthiness, flight performance, and safety of the finished model. SIG MFG. CO.'s obligation shall be to replace those parts of the kit proven to be defective or missing. The user shall determine the suitability of the product for his or her intended use and shall assume all risk and liability in connection therewith.

## **WARNING! THIS IS NOT A TOY!**

Flying machines of any form, either model-size or full-size, are not toys! Because of the speeds that airplanes must achieve in order to fly, they are capable of causing serious bodily harm and property damage if they crash. **IT IS YOUR RESPONSIBILITY AND YOURS ALONE** to assemble this model airplane correctly according to the plans and instructions, to ground test the finished model before each flight to make sure it is completely airworthy, and to always fly your model in a safe location and in a safe manner. The first test flights should only be made by an experienced R/C flyer.

**SIG MFG CO., INC. 401 S. Front St. Montezuma, Iowa 50171 U.S.A.**