

ASSEMBLY MANUAL

T-Clips 70



KIT NO. SIGRC108EGARF



For Electric or Glow Power!



ALMOST READY TO FLY

SPECIFICATIONS:

Wing Span: 70 in. (1778 mm)
Wing Area: 860 sq.in. (55.5 dm²)
Length: 50 in. (1270 mm)
Flying Weight: 7 - 7.8 lbs. (3175-3538 g)
Wing Loading: 19 - 21 oz./sq.ft. (57-64 g/dm²)
Radio Required: 4-Channel with 5 Standard Servos (glow)
4-Channel with 4 Standard Servos (electric)
Glow Power: 2-Stroke .53 - .61 cu.in. (8.6 - 10.0 cc)
4-Stroke .53 - .65 cu.in. (8.5 - 10.7 cc)
Electric Power: 1200-1700 watt Brushless Motor; 300-400 kv
75A Speed Control (ESC)
4S - 6S 4000-5000 mah Lipo Battery Pack



SIG MFG. CO., INC. PO Box 520 Montezuma, IA 50171-0520
www.sigmfg.com



INTRODUCTION

Congratulations on your purchase of the SIG T-CLIPS 70 EG ARF. We hope you will enjoy this unique fun scale R/C model.

Assembly of your T-CLIPS 70 is fast and simple when following the detailed instructions in this manual. We urge you to read this assembly manual completely before assembly. Familiarize yourself with the parts and the assembly sequences. The successful assembly and flying of this airplane is your responsibility. If you deviate from these instructions, you may wind-up with problems later on.

Good luck with the T-CLIPS. Let's get started!

ADDITIONAL ITEMS YOU WILL NEED TO PURCHASE

In addition to this kit, you will need the following items to complete your T-CLIPS and make it flyable.

RADIO SYSTEM

The T-Clips 70 requires a standard 4-channel radio system and either four or five standard size servos (four servos is using electric power, or 5 servos if using glow engine power). "Standard" size servos typically have 40-60 oz. of torque. In addition, you'll need two 6"- 12" long Servo Extension Cords and one Y-Harness Chord for connection of the two aileron servos to the receiver. (The length of extension cord you will need depends on how long the wires are coming off your servos. With Hitec® standard servos we used 6 in. long extension cords. Check your servos and plan accordingly.)

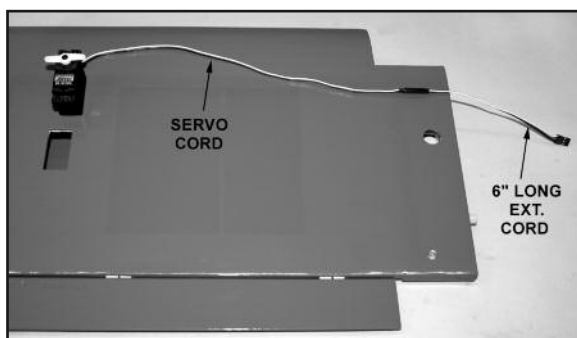
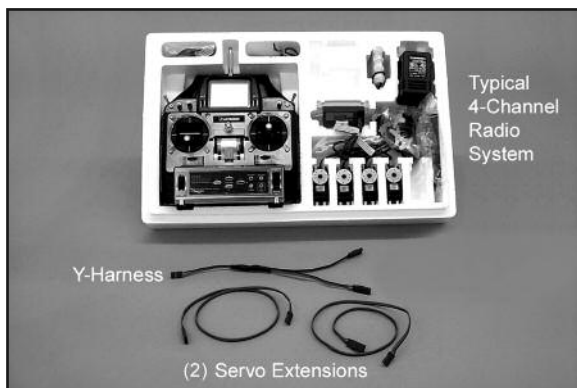

POWER SYSTEM - GLOW OR ELECTRIC?

The biggest decision you will have to make is whether to power your T-CLIPS with a glow engine (2-stroke or 4-stroke) or an electric motor. We have flown the T-CLIPS 70 with a variety of both types of power systems, and we make the following recommendations based on our successful on-field experience.

GLOW POWER RECOMMENDATIONS

ENGINE

We recommend the following size engines for the T-CLIPS 70.

2-STROKE - .53 to .61 cu. in.

4-STROKE - .53 to .65 cu. in.

Whatever brand engine you choose, take the time to carefully break it in according to the manufacturer's instructions. A good running, reliable engine is a minimum requirement for the enjoyment of this or any R/C model aircraft.

PROPELLER FOR GLOW

Refer to the engine manufacturer's instructions for recommendations on proper propeller size for their engine. In our experience, most .60 size 2-stroke glow engines will fly the T-CLIPS 70 very nicely with a 12x8 or 13-6 prop.

ELECTRIC POWER RECOMMENDATIONS

1200 - 1700 watt BRUSHLESS OUTRUNNER MOTOR

The T-CLIPS 70 is designed to be powered with a 1200 to 1700 watt electric brushless outrunner motor. This size motor is sometimes referred to as a "60" class motor to those who like to make a comparison to a glow motor. Also, the motor you choose should be rated at 300-400 kv, in order to turn an appropriate propeller.

Here is are some motor sizes that work well in the T-CLIPS 70:

5030-390

5062-400

5065-400

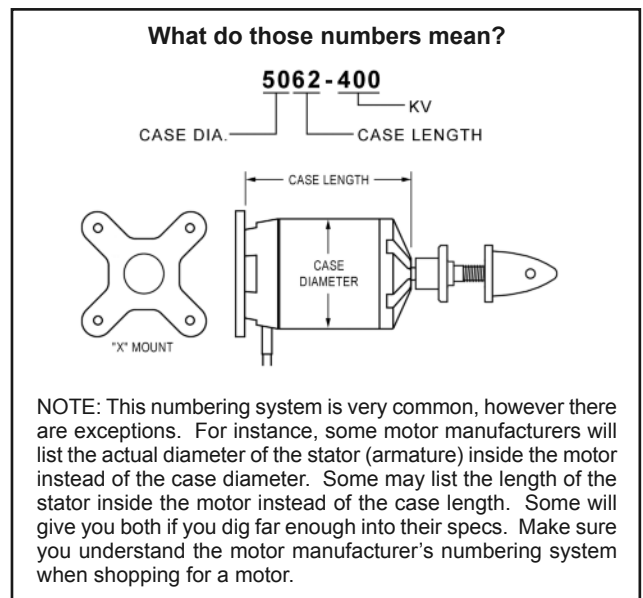

MOTOR MOUNT

A laser-cut plywood adjustable motor mount is included in this kit. It should work perfectly for any suitable brushless outrunner motor which has an "X" or "cross" motor mount plate on the back.

60-75 amp ESC (Electronic Speed Control)

We used the Castle Creations® 75 amp ESC in our T-CLIPS prototypes. This is an excellent "switching type" ESC that has a built-in BEC (Battery Eliminator Circuit).

Note: BEC allows you to use the same battery pack to power both

your motor and your radio system, eliminating the normal radio battery pack. When the single battery pack runs down in flight to a prescribed point, the BEC circuit in the ESC will shut down the motor and leave enough power to operate the radio while you land the model. Note that the BEC feature in some cheaper ESCs does not work with 4 cell and larger lipo battery packs - only 3 cell packs. Check carefully to make sure you know all the specifications of the ESC that you are buying.

4 cell 5000mah or 6 cell 4000mah LIPO BATTERY PACK

You can fly your T-CLIPS 70 with a 4 cell (4S1P) or 6 cell (6S1P) Lipo pack. Pack capacity should be 4000-5000 mah for good flight duration. We find that 6s 4000mAh lipo packs provide between 8 to 10 minutes of flight time, depending on propeller selection and other factors (quality of pack, throttle management, outside temperature, etc.).

CAUTION: You must match your propeller size to the cell count of your lipo pack, to avoid drawing too many amps and damaging your ESC or motor.

PROPELLER FOR ELECTRIC

With electric powered models there are many factors that have a bearing on what propeller to use. The best place to start answering that question is in the instructions that come with your motor. Another fine source of information is one of the [electric flight calculators](#) that are available for you to use free online (there is a good one on Castle Creations web site).

OUR FLIGHT TEST REPORT

One of our favorite setups for the T-CLIPS 70 was a Maxx Products® HC5030-390 motor with a 75 amp ESC, a 6-cell (6S1P) 22.2v lipo pack, and an APC® 15x8E propeller. An APC 15x10E propeller also worked well. Both sizes delivered good performance, very reminiscent of a 2-stroke .75 glow engine. For a starting prop we recommend the APC 15x8E. Other brand propellers of same size and similar design can also be used.

This combination gave outstanding flight performance. When using a 6S 4000 mah lipo, we had flight times around 8-10 minutes, depending of course on throttle management. A 5000 mah lipo pack provided about 12 minutes of flight time. Your results may vary. Prop size, size and quality of the battery pack, throttle management, air temperature, etc., all have a bearing on electric flight performance and flight time. Experiment to find the best combination for your setup.

BATTERY CHARGER

FOR SAFETY AS WELL AS PERFORMANCE, CHARGE LIPO BATTERIES ONLY WITH A LIPO BATTERY CHARGER!

In addition to providing the critical charging profile needed to safely charge lipo batteries, a lipo battery charger also includes the capability of "balancing" the available voltage in the cells, ensuring that the battery pack is at peak capacity at the end of the charge cycle. This translates to better flight times and a longer life from the battery pack.

REQUIRED TOOLS

For proper assembly, we suggest you have the following tools and materials available:

A selection of glues - SIG Thin, Medium, & Thick CA Glue
CA Accelerator, CA Debonder
SIG Kwik-Set 5-Minute Epoxy

Screwdriver Assortment

Pliers - Needle Nose & Flat Nose

Diagonal Wire Cutters

Small Allen Wrench Assortment

Pin Vise for Small Dia. Drill Bits

Hobby Knife with Sharp #11 Blades

Small Power Drill With Selection of Bits

Dremel® Tool With Selection of Sanding & Grinding Bits

Scissors

Sandpaper

Covering Iron & Trim Seal Tool

Masking Tape

Paper Towels

Alcohol and/or Acetone For Epoxy Clean-up

COMPLETE KIT PARTS LIST

The following is a complete list of all parts contained in this kit. Before beginning assembly, we suggest that you take the time to inventory the parts in your kit. Use the check-off boxes provided in front of each part description. Please also note that the bolts and nuts required to mount your engine to the motor mounts are not included and must be purchased separately.

- (1) Fuselage
- (1) Right Wing Panel & Aileron, hinges not glued
- (1) Left Wing Panel & Aileron, hinges not glued
- (1) Stabilizer & Elevator, hinges not glued
- (1) Fin & Rudder, hinges not glued
- (1) Fiberglass Cowling
- (1) Windshield
- (1) Right Side Window
- (1) Left Side Window
- (1) Aluminum Main Landing Gear
- (2) 3" dia. Main Wheels
- (2) 4mm dia. Steel Axles
- (2) Hex Nuts; for axles
- (4) 4mm ID Wheels Collars; for axles
- (1) Tailwheel Assembly, including Wheel, Formed Wire, Nylon Bearing, & Wheel Collars(2)
- (1) Nylon Rudder Steering Clasp, including M2 x 15mm Bolt & M2 Hex Nut
- (1) Right Fiberglass Wheel Pant
- (1) Left Fiberglass Wheel Pant
- (1) Aluminum Tube Wing Joiner
- (2) Plastic Cinch Straps
- (1) Plywood Electric Motor Mount Assembly
- (1) Balsa Triangle Stock; for motor mount reinforcement
- (2) Velcro® Straps
- (7) M4 x 20mm Socket-Head Bolts; for electric motor mount(4) & main landing gear(3)
- (4) M4 Flat Washers; for electric motor mount
- (4) M4 x 16mm Socket-Head Bolts; for electric motor
- (7) M4 Split-Ring Lock Washers; for electric motor(4) & main landing gear(3)
- (4) M4 Blind Nuts; for mounting electric motor
- (2) M6.5 Nylon Wing Bolts
- (7) M2.3 x 7mm Screws, for windshield
- (4) M3 x 10mm Screws, for cowling
- (4) M3 x 10mm Socket-Head Bolts, for wheel pants
- (4) Nylon Control Horns; for ail(2); elev(1); rud(1)
- (12) M2 x 15mm Screws; for control horns
- (4) Nylon Snap Keepers; for ail(2), ele(1), rud(1)
- (5) Metal R/C Clevis; for ail(2), ele(1), rud(1), throttle(1)
- (5) Small pieces of Fuel Tubing; for R/C clevis keepers
- (1) Small Balsa Block; for glow throttle pushrod
- (1) Pushrod Connector w/Set Screw, for throttle
- (2) Glow Engine Mounts
- (4) M4 x 25mm Mounting Bolts, for glow engine mounts
- (4) M4 Flat Metal Washers, for glow engine mounts
- (1) Fuel Tank
- (1) Fuel Tank Rubber Stopper Assembly
- (1) Fuel Tank Pick-Up Weight, Metal
- (1) Fuel Line Tubing, for inside tank
- (2) 7-1/8" long Wire Pushrods, threaded on one end, with M2 Hex Nuts(2); for ailerons

- ❑ (1) 17-3/4" long Wire Pushrod, threaded on one end, with M2 Hex Nut; for throttle
- ❑ (2) 28" long Wire Pushrods, threaded on one end, with M2 Hex Nuts(2); for elevator & rudder
- ❑ (1) 11-3/4" long Nylon Pushrod Tube, for throttle
- ❑ (1) Plywood Throttle Servo Mount
- ❑ (1) Plywood Fuel Tank Front Mount
- ❑ (1) Plywood Fuel Tank Rear Mount
- ❑ (2) Plywood Battery Battery Box Sides
- ❑ (1) Plywood Battery Battery Box Top
- ❑ (1) Strip of Red Covering Material

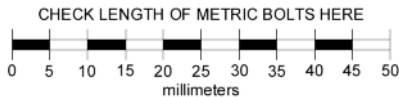

COVERING MATERIAL

Your T-CLIPS ARF is covered with ORACOVER®, a premium quality covering made in Germany, and sold in the U.S. by Hanger-9 as Ultracote®.

Colors Used On Your Airplane

ORACOVER® #23 Ferrari Red (Ultracote® #HANU866)
and
ORACOVER® #71 Black (Ultracote® #HANU874)

If sometime in the future you need replacement covering or matching paint for repairs, they are available from your local hobby dealer or online from Hanger-9.

How To Tighten Loose Covering

After you open your T-CLIPS and take all the covered parts out of their plastic bags, the covering may begin to wrinkle. This is not unusual and is no cause for alarm. Your airplane was built and covered in a part of the world which has relatively high humidity and therefore, the wood was likely carrying a fair amount of moisture. When exposed to drier air, the wood typically loses this moisture, dimensionally "shrinking" in the process. In turn, this may cause some wrinkles. However, wrinkles are easy to remove by just using a hobby type heat iron.

Caution: Trying to remove the wrinkles by hastily going over them with a heat gun can lead to more problems. You should take your time to carefully go over the entire model with a covering iron, as we will describe.



We suggest using a model airplane covering iron for this process. Cover the iron's shoe with a thin cotton cloth, such as an old t-shirt, to prevent scratching the covering as you work.

After covering your iron, the next step is to set the iron to the correct temperature. This is critical for achieving a good result! The iron should be set to about **220°F - 250°F (104°C - 121°C)** as

measured on the bottom of the iron using a thermometer. If you do not have a thermometer, you can find the correct temperature by trial and error. Set your iron to a medium setting. Glide the iron over some of the covering that is over solid wood, such as the sheeted wing center section. Observe the covering to see if any bubbles appear. If bubbles appear, the covering is getting too hot! Turn down the temperature of the iron and repeat the test.

If no bubbles appear, turn up the heat slightly and repeat the test. Keep adjusting until you "zero in" on the correct temperature. Find the temperature that will get the covering to stick down without forming bubbles or causing the seams to pull away.

Once your iron is set to the correct temperature, go over the entire framework of the airplane, making sure that the covering is securely bonded to the structure everywhere the covering comes in contact with the wood underneath. This takes some time, but is worth the effort.



After you have all the covering secured onto the solid areas, turn the temperature of the iron up to approximately **300°F - 320°F (149°C - 160°C)**. This is the correct temperature for shrinking the covering material.

Use the iron to tighten up any wrinkles in the "open" areas of the model (no wood underneath the covering). Glide the iron over the wrinkle for a few seconds, then remove. Repeat until the covering is tight with no wrinkles.

If wrinkles keep coming back on the tail surfaces, you may need to "ventilate" the areas between the ribs. Otherwise the air that is sealed in those relatively small areas will expand when the heat is applied and actually cause the covering to stretch instead of shrink. Use a pin to poke a tiny hole in the covering between each rib, on the bottom of the part. That will let the expanding air escape and the covering to shrink properly.

Caution When Using Heat Guns: You can also use a hobby-type heat gun to shrink the covering, but you must be careful around seams or color joints. Getting too much heat on the seams may cause them to "creep" or come loose. You must also be careful when using a heat gun when working around the windshield and side windows - heat will distort the clear plastic material.

Recommended Temperatures:

To adhere the covering - 220°F - 250°F (104°C - 121°C)
To shrink the covering - 300°F - 320°F (149°C - 160°C)

NOTE: In this manual, any references to right or left, refer to your right or left as if you were seated in the cockpit of the airplane.

WING ASSEMBLY

The wings are designed as a 2-piece system, with separate right and left wing panels joined by an aluminum tube Wing Joiner and a hardwood locating Pin at the rear. Due to the high strength of the wing joiner tube, the wing panels do not need to be permanently glued together. Gluing them permanently together is optional - your call. The obvious benefit to leaving the wing panels separate is the fact that they can be easily transported or stored, requiring a minimum of space.

To help protect your wings during the following steps we recommend that you cover your work surface with a soft cloth or piece of foam.

INSTALLING THE AILERON SERVOS

For the following steps you will need:

- (1) Right Wing Panel
- (1) Left Wing Panel
- (1) Aluminum Tube Wing Joiner
- (2) Servos with Mounting Screws (not furnished)
- (2) 6" Servo Extension Cords (not furnished)
- (1) Servo Y- Harness (not furnished)

□ 1) Mount the aileron servos in the bottom of each wing panel.

a) The servo bays are pre-cut for you but you'll want to double check the covering around the cutout to make sure it is sealed down tight.

b) Install the rubber grommets and brass eyelets (supplied with your radio system) into each aileron servo.

c) Install the control arms on the two aileron servos. The arms should be at 90 degrees to the servo when the aileron control stick on the transmitter is in neutral and the transmitter trims are in neutral as well.

d) Before installing the aileron servos in the wing panels you must attach a servo extension cord to the aileron servo wire. The typical combined length required is approximately 18". A 6" extension cord will usually provide sufficient length. Plug the servo plug into the extension cord and tape the plugs together for added security.

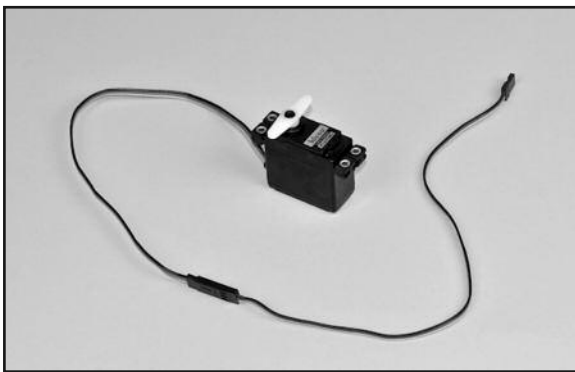

e) Holding the wing panel with the wingtip UP, drop the end of the extension cord into the servo mount cutout and then thru the openings in the wing ribs, working it towards to the center end of the wing panel. The plug on the end of the extension cord will occasionally get hung up on the ribs, however by turning or gently shaking the wing panel you can get it to fall through the openings in the ribs, until it emerges at the end rib. Once you've got the plug to the end rib, direct it through the round hole in the bottom surface of the wing panel. By that time, the servo itself should be next to the servo mount cutout and ready for mounting.

f) Fit the servo into the servo mount in the wing panel, (note that the servo is positioned so that the servo arm is at the forward end toward the wing leading edge). Take up any slack in the servo cord as you insert the servo in the mount. Use a pin vise and a small drill bit to drill small pilot holes in the servo mount for the

servo mounting screws. Use the screws supplied with your radio system to mount the servo in place on the servo mount. Repeat this procedure to mount the servo in the opposite wing panel.

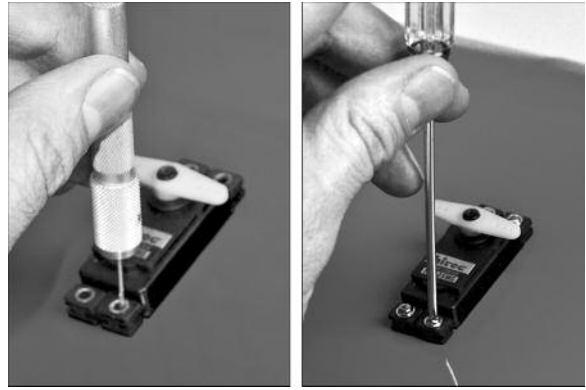

HINGING THE AILERONS

□ 2) Note that the CA Hinges are installed, but not yet glued, in the ailerons and wing panels. The installation process for the hinges is the same for all of the control surfaces on this model.

a) If you removed the ailerons and hinges from the wing panels when you tightened the covering material, reinstall them now. First insert the five CA Hinges into the slots in the aileron. Put two pins in the center of each hinge, up against the leading edge of the aileron, to keep the hinges centered during the next step.

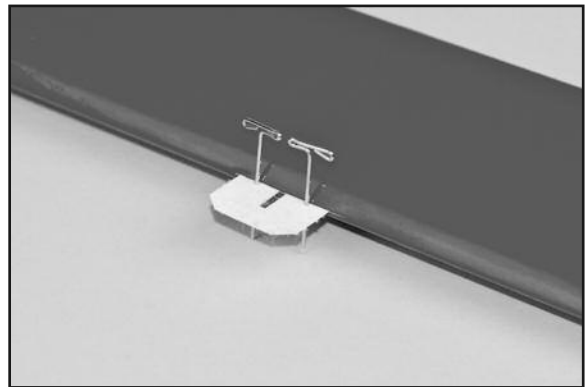

b) Now carefully insert the exposed portion of the five hinges into the trailing edge of the wing. You will find it easiest to slide the hinges into the slots at angle, one hinge at a time, instead of trying to push it straight onto all the hinges at once.

c) Adjust the aileron so that the tip of the aileron is flush with the wing tip. The ailerons should be tight against the pins in the hinges to minimize the gap between the wing and the aileron. The aileron is now in the proper position for permanently gluing them in place with thin CA glue.

d) Flex the aileron down and hold it in this position. Remove the pins from one hinge and then carefully apply 3-4 drops of Thin CA glue directly onto the hinge in the gap. You will notice that the glue is quickly wicked into the slot as it penetrates both the wood and the hinge. We suggest using a fine tipped applicator on the glue bottle to better control the flow of glue.



e) Turn the part over and glue the other side of the hinge. Continue this process until you have glued both sides of all the hinges! Keep a rag handy to wipe off any excess Thin CA glue. (If you get some glue smears on the plastic covering, don't worry about them right now. Once all the hinging is done, you can clean the smears off the covering with CA Debonder).

f) Let the glue dry 10-15 minutes before flexing the hinges. At first you might notice a little stiffness in the joint. This will go away after the hinges have been flexed back and forth a couple dozen times.

INSTALL AILERON CONTROL HORNS & PUSHRODS

From the kit contents locate:

- (2) Nylon Control Horns
- (6) M2 x 15 mm Screws
- (2) Short Pushrod Wires with M2 Hex Nut
- (2) Metal R/C Clevis
- (2) Nylon Snap Keepers
- (2) small pieces of Fuel Tubing

□ 3) Look closely and you will see three holes pre-drilled in the bottom of the ailerons for mounting the nylon control horns. Screw the control horn in position on the bottom of the aileron using three M2 x 15mm screws.

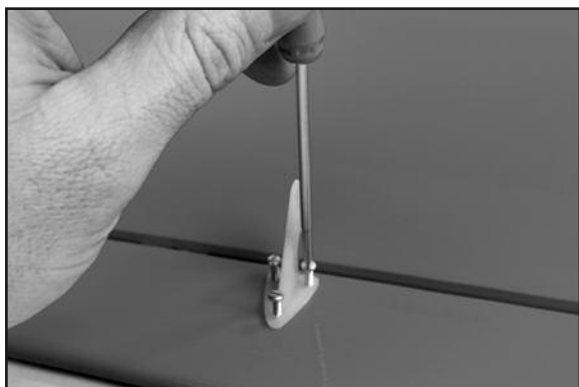

When the tips of the screws begin to emerge at the top surface of the aileron, add the control horn's nylon retaining plate. The aileron will be sandwiched between the control horn on the bottom and the retaining plate on the top. Continue turning in the screws until the horn and retaining plate are snug against both surfaces of the aileron. Do not over tighten the screws and crush the wood.

The excess length of the screws that is extending past the retaining plate can be cut off with a pair of side cutting pliers or ground down with a rotary tool with a cutoff disc.

□ 4) Next assemble and install the aileron pushrods.

a) Slide a short piece of Fuel Tubing onto the small end of the Metal R/C Clevis. Screw the Hex Nut on the Aileron Pushrod Wire all the way up to the end of the threads. Then screw the metal clevis halfway onto the threaded end of the Aileron Pushrod Wire.

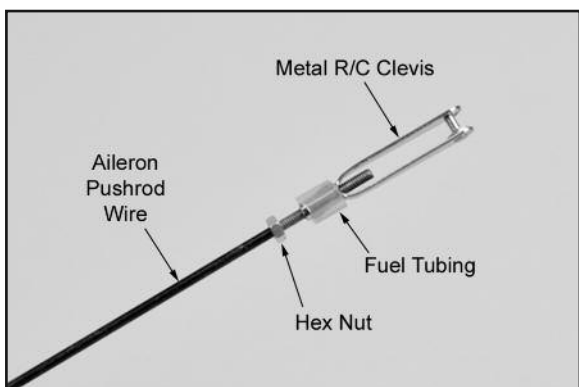

b) Clip the metal clevis into the last hole in the nylon control

horn. Lay the other end of the pushrod wire over the outer hole in the servo arm. Use a felt tip pen to mark the wire where it crosses the hole. Use a pair of pliers to put a sharp 90-degree bend in the wire at the mark.

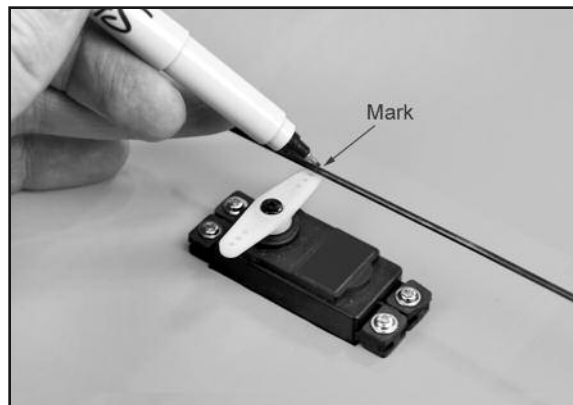

c) Insert the bent end of the pushrod into the servo arm, from the top. Note: You will most likely need to use a 1/16" dia. drill to open the hole in the servo arm to accept the pushrod wire.

d) Mark and cut off the excess end of the pushrod wire, leaving 1/8" of wire protruding below the bottom of the servo arm.

e) Clip a Nylon Snap Keeper in place on the servo end of the pushrod wire. Snap the free end of the keeper up and over the protruding end of the pushrod wire, underneath the servo arm.

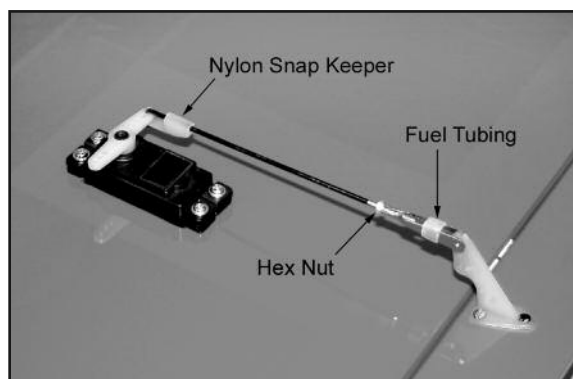

f) Check that the aileron servo is in neutral position and adjust the metal clevis as needed to get the aileron in neutral position.

VERY IMPORTANT

CORRECT NEUTRAL POSITION FOR T-CLIPS AILERONS

Adjusting the neutral position of the ailerons of the T-CLIPS is a bit different than most models, due to the T-CLIPS unique airfoil shape. The T-CLIPS airfoil is flat on the bottom from the main spar back to the trailing edge of the wing panel. DO NOT line the aileron up with this flat bottom portion of the airfoil. That would set the both ailerons too high and be detrimental to the flight characteristics of the airplane.

The center line of the ailerons must be lined up with the center line of the airfoil, as shown in this drawing.

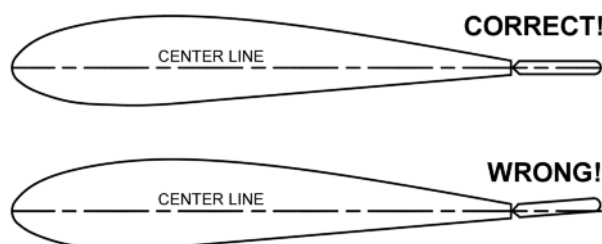

g) Once the ailerons are properly adjusted, insure that the metal clevis can't open up and come loose from the control horn

by sliding the piece of Fuel Tubing over the arms of the clevis. Also tighten the M2 Hex Nut up against the back of the clevis.

□ 9) Check the orientation of the landing gear to make sure you know which way is forward. The two outer holes for mounting the gear to the fuselage go to the front. Test fit the wheel pants over the wheels and line up the predrilled mounting holes. Secure the wheel pants in place with two M3 x 10mm socket head bolts on each pant.

FUSELAGE ASSEMBLY

INSTALL THE MAIN LANDING GEAR

Locate the following parts from the kit contents:

- (1) Fuselage
- (2) Aluminum Main Landing Gear
- (3) M4 x 20mm Socket-Head Bolts
- (3) M4 Split-Ring Lock Washers
- (2) 3" dia. Main Wheels
- (2) 4mm dia. Steel Axles
- (2) Hex Nuts; for axles
- (4) 4mm ID Wheel Collars; for axles
- (1) Right Fiberglass Wheel Pant
- (1) Left Fiberglass Wheel Pant
- (4) M3 x 10mm Socket-Head Bolts

NOTE: We suggest you use a thread locking liquid (like Loctite®) on all bolts and nuts used in the assembly of the landing gear.

□ 5) Install a Threaded Axle into the large hole of the landing gear leg, with the plain end of the axle shaft pointing to the outside. Secure the axle with one of the large Hex Nuts. When tightening the hex nut, keep the flats of the nut on the axle side of the gear leg parallel to the front edge of the leg - see photo. This allows the hex nut to fit inside the narrow notch in the wheel pants when they are added later.

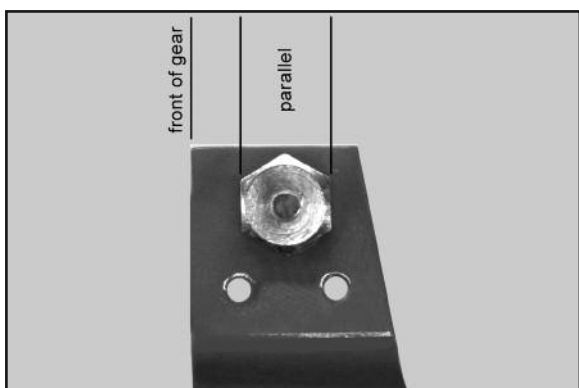

□ 6) Slide a 4mm Wheel Collar onto the axle shaft, but leave approximately 1/8" of space between it and the nut, to provide proper spacing of the wheel in the wheel pant. Tighten the wheel collar set screw securely.

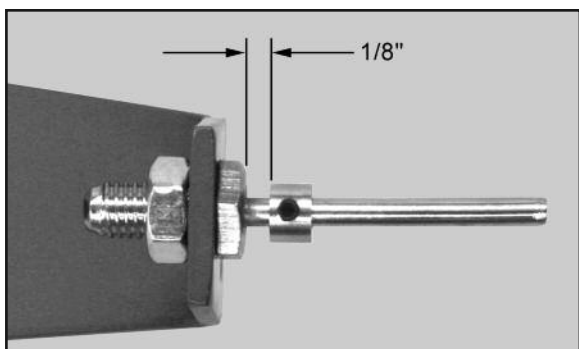

□ 7) Next slide one of the Main Wheels onto the axle and test to make sure it spins freely. If it does not turn freely, drill out the plastic hub of the wheel with an 11/64" or #17 drill bit.

□ 8) Slide a second Wheel Collar onto the axle and up to the wheel. Leave a small gap between it and the wheel, so the wheel will turn freely, and then tighten the wheel collar set screw.



□ 10) Using three M4 x 20mm Socket-Head Bolts and three M4 Split-Ring Lock Washers attach the landing gear to the fuselage.

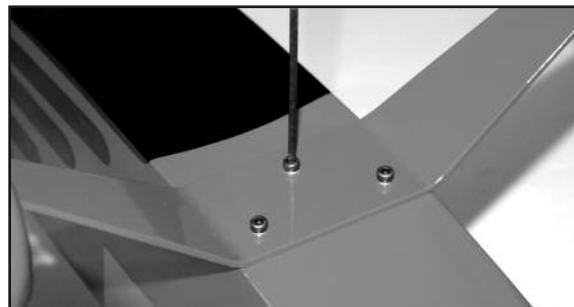

TAIL SURFACE INSTALLATION

For the following steps you will need:

- (1) Fuselage
- (1) Wing
- (1) Stabilizer & Elevator set.
- (1) Vertical Fin & Rudder Set
- (2) M6.5 Nylon Wing Bolts
- (1) Tailwheel assembly, including Wheel and Wheel Collars
- (2) M3 x 12mm Screws
- (1) Nylon Rudder Steering Clasp with Bolt and Hex Nut
- (2) Nylon Control Horns
- (6) M2 x 15mm Screws

□ 11) Just like the aileron hinges, the elevator hinges are factory installed, but not yet glued. Hinge the elevator assembly to the stabilizer, using the same techniques you did for the ailerons - refer to page 5 of this manual. Let the hinges dry adequately before proceeding.

□ 12) Look closely and you will see three holes pre-drilled in one of the elevators for mounting a nylon control horn. Screw the control horn in position on the bottom of the right elevator, using three M2 x 15mm screws. When the tips of the screws begin to emerge at the top surface of the elevator, add the control horn's nylon re-

taining plate. Continue turning in the screws until the horn and retaining plate are snug against both surfaces of the elevator. Do not over tighten the screws and crush the wood.



□ 13) Bolt the wing in place on the fuselage with the Nylon Wing Bolts provided. Then pin the stabilizer and elevator assembly in place on the fuselage. It's time to check the alignment of the stabilizer to the wing.

a) First view the model from directly in front. Check to see if the stabilizer is level with the wing. You should find it to be very close. If necessary use a sanding block to fine tune the stabilizer platform to level the stabilizer to the wing.

b) Next use a tape measure to measure the distance from each stab tip to the back edge of the wing - the distance should be equal on both sides. Adjust if necessary. When you are satisfied with the alignment, proceed to the next step

□ 14) The horizontal stabilizer is now glued in place into the rear of the fuselage. We suggest using slow drying epoxy glue for this job to allow time to position the stab accurately and make any final adjustments that might be needed. Apply the glue to both sides and reset the stab in place. Use pins to hold it in place. Recheck the alignment. Wipe away any excess epoxy with rubbing alcohol and a soft paper towel. Allow the glue to set completely.



□ 15) Pull the Fin and Rudder off their hinges and set the rudder aside for now. Test fit the fin in place on top to the fuselage and stabilizer. Check to see that the fin sits flush and perpendicular to the stabilizer.



□ 16) Glue the fin in place using slow drying epoxy glue. Apply a thin coat of glue to the bottom of the fin and to the exposed wood on the stab. With the fin in place, sight the model from the front to make sure the fin is absolutely 90 degrees upright to the stab. If needed, use a little masking tape to hold it in alignment. Wipe off any excess glue rubbing alcohol and a soft paper towel.

□ 17) Hinge the rudder to the fin and the rear of the fuselage using the same techniques you did for the other hinges - refer to page 5 of this manual. Make sure to line up the top of the rudder flush with the top of the fin. This will ensure the tail wheel bracket lines up correctly. Let the hinges dry adequately before proceeding.

□ 18) Look closely and you will find three holes pre-drilled near the bottom of the rudder for mounting a nylon control horn. Install the control horn on the left side of the rudder, with the retaining plate on the right, using three M2 x 15mm screws.



TAILWHEEL INSTALLATION

□ 19) Mount the Tailwheel assembly in place on the lower rear end of the fuselage, using two M3 x 12mm screws. Note that there are two pilot holes already in the fuselage for the screws.



□ 20) Adjust the wheel collar shown to set the height of the tail-wheel wire. Then check to see if the long steering leg of the tail-wheel wire is parallel to the bottom of the rudder. The wire may need to be tweaked slightly to make it parallel.

□ 21) Slide the Nylon Rudder Steering Clasp onto the bottom of the rudder and onto the tailwheel wire at the same time. Locate

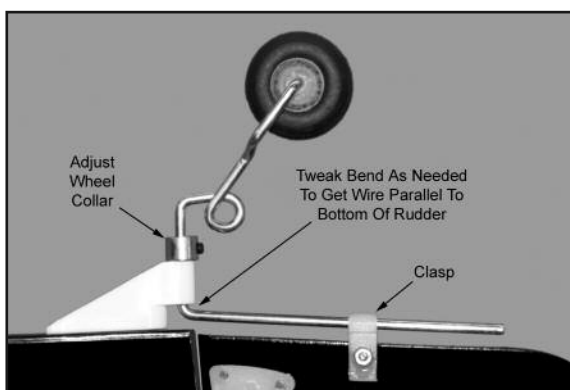

the clasp at the halfway point on the wire, and then drill a hole for the M2 x 15mm Bolt. Insert the bolt through the hole and tighten down the M2 Hex Nut to clamp the bracket in place.

RADIO INSTALLATION

For this section you will need:

- (1) Radio Receiver (not furnished)
- (2) Servos with Mounting Screws (not furnished)

□ 22) Install the rudder and elevator servos inside the fuselage in the built-in plywood radio mounting tray. Note that the rudder servo goes on the right side of the airplane, and the elevator servo goes on the left side. Be sure to drill pilot holes through the plywood tray for the mounting servo mounting screws.

□ 23) Figure out where and how to mount your receiver. This can depend on several factors, starting with whether you are using a glow engine or an electric motor for power. We decided to mount the receiver of our photo model, which will be electric powered, on the left side of the fuselage, using a short piece of common Velcro® tape (not furnished).

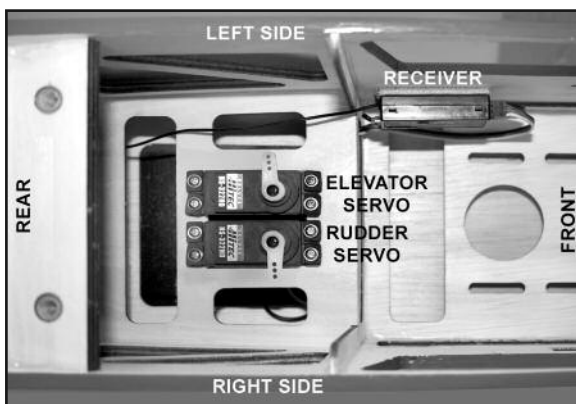

ELEVATOR & RUDDER PUSHROD INSTALLATION

For this section you will need:

- (1) Fuselage
- (2) 28" Long Pushrod Wires with M2 Hex Nut
- (2) Metal R/C Clevis
- (2) Nylon Snap Keepers
- (2) small pieces of Fuel Tubing

□ 24) Assemble and install the elevator pushrod.

a) First slide a small piece of Fuel Tubing onto the small end of the Metal R/C Clevis. Next screw the Hex Nut that is on the Pushrod Wire all the way up to the end of the threads. Then screw the metal clevis halfway onto the threads.

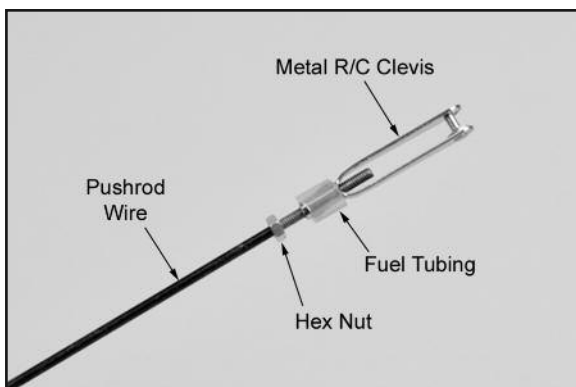

b) Locate the pre-cut pushrod exit hole for the elevator on the right side of the fuselage at the back of the plane. Slide the pushrod into the exit hole and inside the pushrod sleeve built into the fuselage. Slide it in until you can clip the clevis into the middle hole of the control horn. Lock the elevator in neutral position with

tape, or with two small balsa wood sticks held together with small rubber bands.



c) Inside the fuselage, hold the pushrod wire over the elevator servo output arm and mark the wire where it crosses over the outer hole in the servo arm.

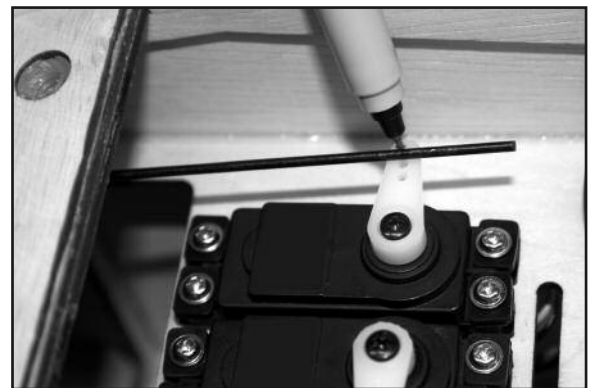

d) At the tail end, unlock the elevator from neutral position, and then unclip the clevis from the control horn. Remove the clevis and the hex nut completely off of the pushrod and set them aside. Now pull the pushrod out of the fuselage from the servo end. It will be easier to complete the next three steps with the pushrod out of the airplane.

e) Cut off the pushrod wire 1/4" past the mark made at the servo end in step c). Then put a sharp 90-degree bend in the wire at the mark.

f) Remove the servo arm from the elevator servo. Drill out the last hole in the servo arm with a 1/16" dia. drill so it will accept the pushrod wire. Then insert the bent end of the pushrod wire into the servo arm, from the top.

g) Clip a Nylon Snap Keeper in place to hold the pushrod wire in the servo arm. Snap the free end of the keeper up and over the protruding end of the pushrod wire, underneath the servo arm.



h) Now slide the pushrod back inside the pushrod sleeve in the fuselage, from the front. When it is in far enough, put the servo arm back in place on the servo.

i) Make sure that the elevator servo is in neutral position and then adjust the metal clevis at the tail end as needed to get the elevator in perfect neutral position.

j) After the elevator is properly adjusted, insure that the metal clevis can't open up and come loose from the control horn by slid-

ing the small piece of fuel tubing over the arms of the clevis. Also tighten the M2 Hex Nut up against the back of the clevis.



□ 25) Locate the pre-cut pushrod exit hole for the rudder on the left side of the fuselage at the back of the plane and repeat step 24) in its entirety to install the rudder pushrod.

ELECTRIC POWER SYSTEM

Skip this section if your using a glow engine power setup

ELECTRIC MOTOR & ESC INSTALLATION

For this section you will need:

- (1) Fuselage
- (1) Plywood Electric Motor Mount
- (1) Balsa Triangle Stock
- (4) M4 x 20mm Socket-Head Bolts
- (4) M4 Split-Ring Lock Washers
- (4) M4 Flat Metal Washers
- (4) M4 x 16mm Socket-Head Bolts
- (4) M4 Split-Ring Lock Washers
- (4) M4 Blind Nuts
- (2) Plywood Battery Box Sides
- (1) Plywood Battery Box Top
- (1) Velcro® Strap
- (1) set Electric Motor, ESC, Prop, Lipo Battery (not furnished)

NOTE: The mounting of the electric motor in the T-CLIPS 70 assumes that your motor has a typical "X" or "cross" mounting plate on the back of the motor. Also note that the firewall portion of the laser-cut plywood motor mount is adjustable fore and aft to accommodate different length motors. Next we will determine where you should set the firewall for your particular motor.

□ 26) Assemble your motor according to the manufacturer's instructions. Then carefully measure the distance from the back of the mounting plate to the front of the thrust washer*.

* The "thrust washer" is the part of the prop adaptor where the back of the propeller will be located.

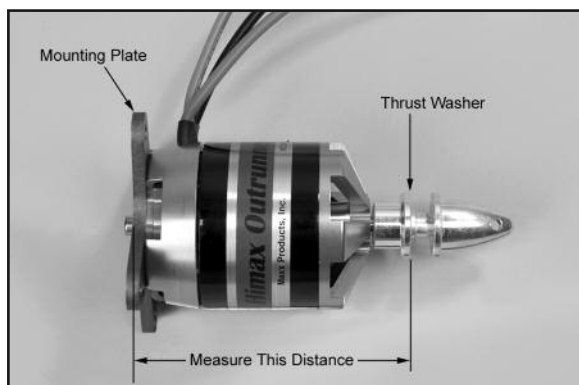

□ 27) For the T-CLIPS 70, you need a distance from the back edge of the motor mount to the motor's thrust washer to end up

exactly 5-1/4", in order for the cowling will fit properly.

a) So what you need to do is to subtract the measurement taken in the previous step (26) from 5.25". The result is the distance you need to set the front of the firewall from the back edge of the plywood motor mount box. (*With the motor we are using in these photos, the motor measurement is 3.21". So 5.25" minus 3.21" = 2.04". Your result may be different depending on your motor.*)

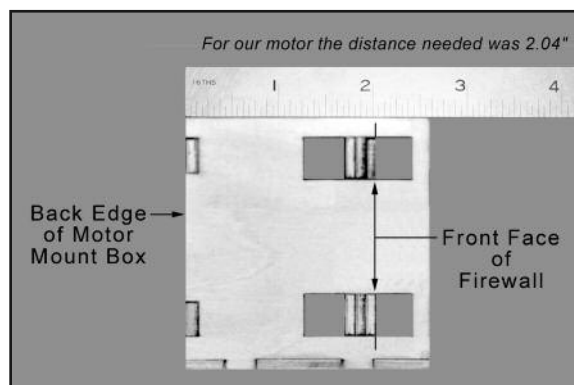

b) Carefully measure and mark the distance determined in the previous step from the back edge of the motor mount box towards the front. Do this along side each of the adjustment slots on both sides of the box (four marks total).

c) After you have all four slots marked, carefully align the front face of the firewall to line up with the marks. Make sure you end up with the firewall straight and square in the box. If it is not, recheck your marks and adjust as necessary.

d) Tack glue the firewall in place. Recheck once more to make sure that the front of the firewall is at the correct distance from the back of the motor mount box. That distance plus the length of your motor must equal 5-1/4". When satisfied it is correct, glue the firewall securely to the rest of the motor mount box.

□ 28) Remove the X mount plate from the back of your motor and center it on the firewall. Once you are sure it is properly located, mark the mounting holes with a pencil. Remove the X mount and drill out the mounting holes with a 7/32" dia. drill. Install four M4 Blind Nuts in the holes, on the back side of the firewall. Put a couple drops of glue on the flanges of the blind nuts to secure them to the plywood. Be careful not to get any of the glue in the threads.

□ 29) Locate the piece of balsa triangle stock provided. Measure, cut and install pieces of triangle stock to reinforce all the corner joints inside the motor mount box.

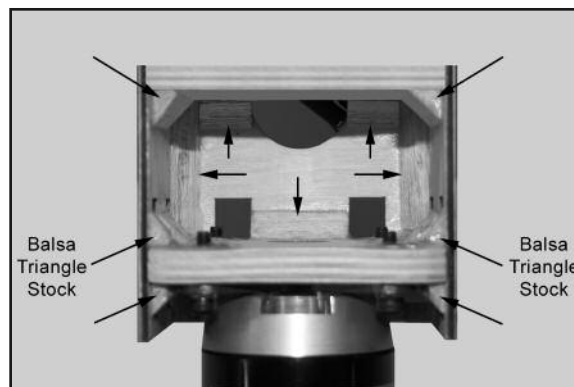

□ 30) If you have not already re-attached the X mount plate to the back of your motor, do so now. Then use (4) M4 x 16mm Socket-Head Mounting Bolts and Lock Washers to bolt your motor in place on the plywood motor mount box.

□ 31) Install your ESC

a) Solder appropriate battery connectors (not supplied) to the

battery leads of your ESC.

b) Decide where you want to install your ESC. We fastened ours to the inside of the fuselage with common Velcro® tape (not furnished).

c) Now route the ESC's servo wire back to the receiver and plug it in.

d) Connect the ESC's motor wires to the motor. Operate the motor and check the direction of rotation. Always do this without a propeller attached! If you need to reverse the rotation, refer to the instructions that came with the motor and ESC. Changing the direction of rotation is normally a simple matter of swapping two of the motor wires.

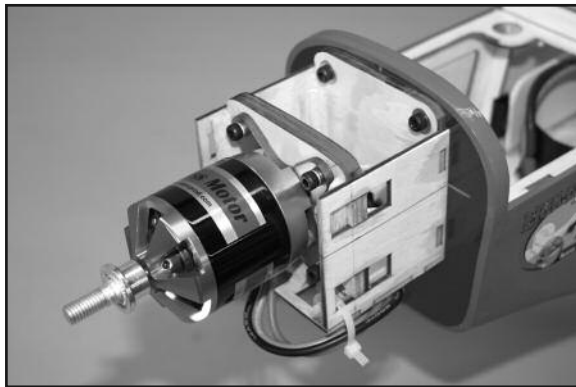
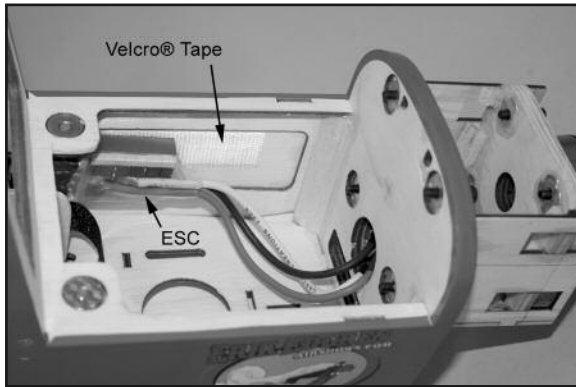

SAFETY ISSUE: We strongly recommend the use of an "arming switch" for your motor installation. With an arming switch you can install your battery pack in the airplane and hook up the wires without danger of the motor starting. The arming switch keeps the electricity away from the motor until you "arm" it when you are ready to takeoff. The most common arming switches are a simple external plug that puts a break in the positive battery lead to the motor, such as the Maxx Products Arming Switch shown below. There are also arming switches built into some of the advanced ESCs now on the market.

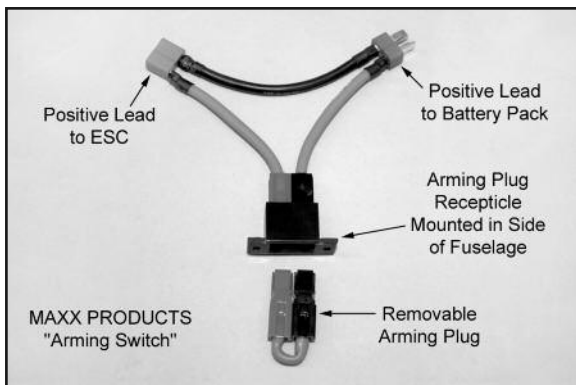

□ 32) The lipo battery pack will ride in a plywood battery box on the floor of the fuselage, just in front of the servo mount. In this step we will assemble and then install the battery box.

a) The battery box consists of (2) plywood sides and (1) ply-

wood top piece. Glue the top and sides together securely.

b) Take one of the supplied Velcro® straps and pull the short "fuzzy" portion loose from the longer "hook" strap. Glue one end of the short fuzzy strap on to one of the box sides, as shown in the following photo. Glue the plain side to the wood, not the fuzzy side. Epoxy glue works best for this step.

c) Cut the hook strap in half, and then glue one end of it to the other box side. The hook side should be glued against the wood. Epoxy glue works best for this step.

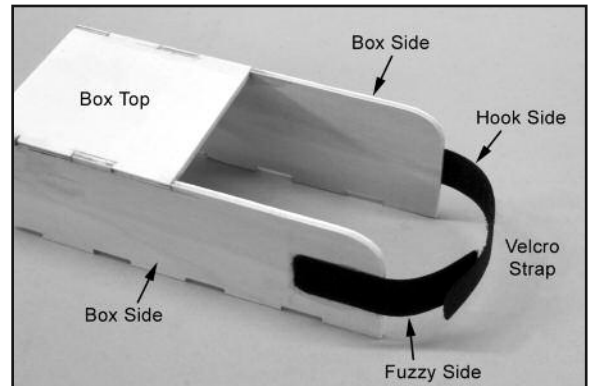

d) Trial fit the assembled battery box inside the fuselage. Note that there are slots in the plywood fuselage floor to accept the tabs on the bottom of the battery box. After you are familiar with the fit of the battery box, glue it permanently to the plywood floor and to the front of the servo mount.

In addition to the Velcro® strap at the front holding your lipo battery pack inside the box, it is also a good idea to use additional Velcro® tape (not furnished) on both the bottom of your battery pack and on the top surface of the plywood floor, to make sure the battery pack will not move around during aerobatics.

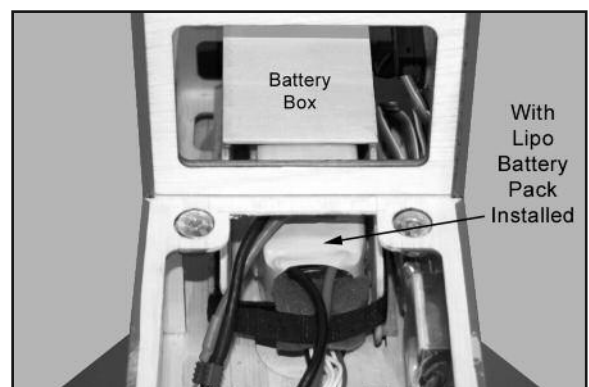
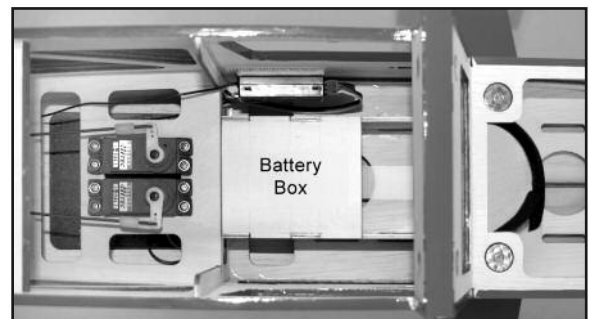

□ 33) For electric power we must let more air flow through the firewall into the fuselage to cool the ESC and lipo battery pack. Look closely at the bottom of the firewall, below the motor mount, and you will see a rectangular shape that is partially cut through the firewall. There are 4 tiny connecting tabs - one on top, bottom, and each side - that hold it in place. With your thumb, push hard on one side of the cutout and it should pop loose as shown in the next photo. Use a knife if necessary. Discard the piece.

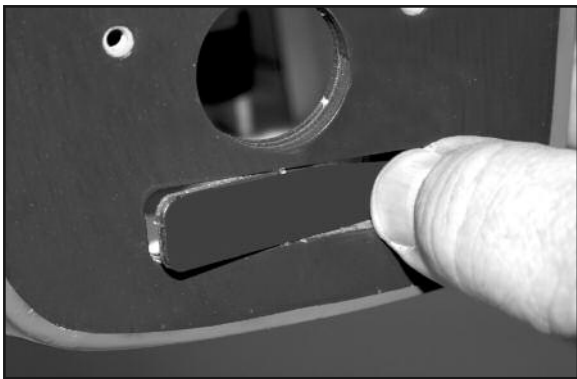

□ 34) If after test flying you find that the ESC or battery are getting warmer than you would like, make an air exit hole in the bottom of the fuselage, as shown here. This will improve the air flow through the fuselage.

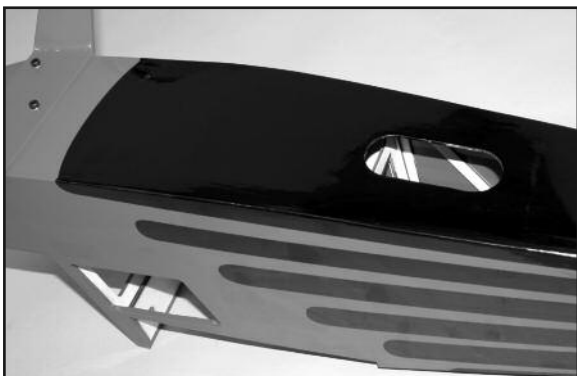

COWLING INSTALLATION

For this section you will need the fuselage and:

- (1) Fiberglass Cowling
- (4) M3 x 10mm Screws

□ 35) Mount the cowling on the fuselage with the four M3 x 10mm Screws provided. Notice that the holes for the four cowl mounting screws are already pre-drilled in the cowling - two on each side.

a) First test fit the cowling on the fuselage. As you pass it over the motor, make sure all the wires are out of the way. Carefully adjust the exact position of the cowling. Make sure you have adequate clearance between the front of the cowl and the back of the propeller, and that the prop shaft is centered in the hole. Use low tack tape to hold the cowling in place for the next step.

b) Use a 5/64" or #45 bit to drill a pilot hole for the top left cowl mounting screw. Center the drill in the hole in the cowling and drill into the fuselage side. Install an M3 x 10mm screw in the pilot hole - do not over-tighten the screw.

c) Recheck the position of the cowling and make any adjustments needed to get it back in position.

d) Now drill another pilot hole for the upper screw on the other side of the cowling. Install the screw.

e) Repeat this process to install the two bottom cowl mounting screws. Remove all the tape.

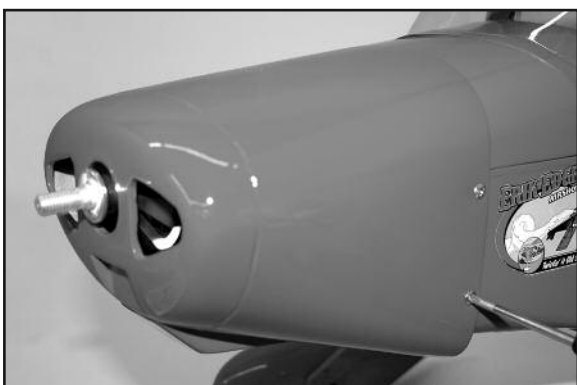

□ 36) With a fully cowled motor, it is very important to make sure your power system is getting proper cooling. Air flowing into the front of the cowling must have a place to exit the cowl. In fact it's best to have more air exit area than inlet area to create a positive air flow through the cowling - an actual suction effect - drawing the heated air out of the cowling so that more cool air can come in. This positive air flow keeps your motor running cool. We recommend that you make a simple opening at the bottom rear edge of the cowling as shown in the next photo, to provide additional air exit area. The exact dimensions are not critical.

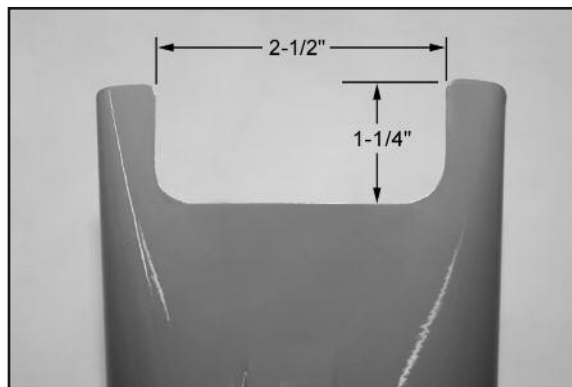

Note: A Dremel® Tool, or similar rotary hand-tool, with an assortment of bits is without a doubt the best tool to use for making cutout in the fiberglass cowling. However, if you do not have access to such a tool, you can cut the opening with a drill, a hobby knife, and a sanding block. First first drill a series of almost touching 1/8" holes inside the pattern lines; then use the knife to cut through the connecting material between each hole; and finally finish the edges of the opening with the file or a sanding block.

□ 37) Mount a suitable propeller on your motor.

GLOW POWER SYSTEM

Skip this section if your using an electric power setup

For this section you will need the Fuselage and:

- (2) Nylon Engine Mounts
- (4) M4 x 25mm Mounting Bolts
- (4) M4 Flat Metal Washers
- (1) Fuel Tank
- (1) Rubber Stopper Assembly
- (1) Fuel Pick-Up Weight (clunk)
- (1) Fuel Line Tubing for inside tank
- (1) Plywood Fuel Tank Front Mount
- (1) Plywood Fuel Tank Rear Mount
- (1) Nylon Throttle Pushrod Tube
- (1) 17-3/4" long Wire Pushrod with M2 Hex Nut
- (1) Metal RC Clevis
- (1) small piece of Fuel Tubing
- (1) Metal Pushrod Connector with Set Screw and Hex Nuts
- (1) Plywood Throttle Servo Mount
- (1) Balsa Block

The T-CLIPS is designed for INVERTED glow engine mounting. We found that to be the most trouble free installation in most cases. However with some glow engines you may want to explore the option of side mounting. Note that the pre-mounted blind nuts for the engine mounts are symmetrically spaced - i.e. the same spacing left-to-right as up-to-down.

The following instructions show a typical 2-stroke glow engine being mounted inverted.

□ 38) Bolt the two Nylon Engine Mounts on the front of the fire-wall, using M4 x 25mm Bolts and M4 Flat Washers provided.

□ 39) Set your engine in place on the beams of the engine mounts. Slide the engine forward or aft on the engine mounts until the front of the engine's thrust washer is 5-1/4" from the front of the firewall. Double check to make sure that the engine is pointing exactly straight forward, and then mark the locations of the engine mounting holes onto the beams of the engine mounts, using a center punch or sharpened nail.

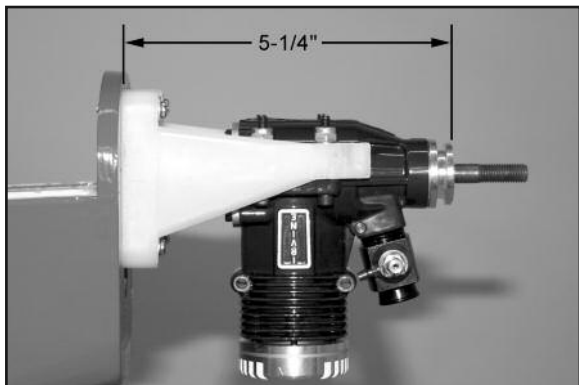

□ 40) Now set your engine aside and unbolt the engine mounts from the firewall. Drill clearance holes for your engine mounting bolts all the way thru the engine mount beams at the four locations you marked in the previous step. TIP: Secure the engine mounts in a vise while you drill the holes. If at all possible use a drill press instead of a hand drill - the job will be much easier and the holes will be straighter.

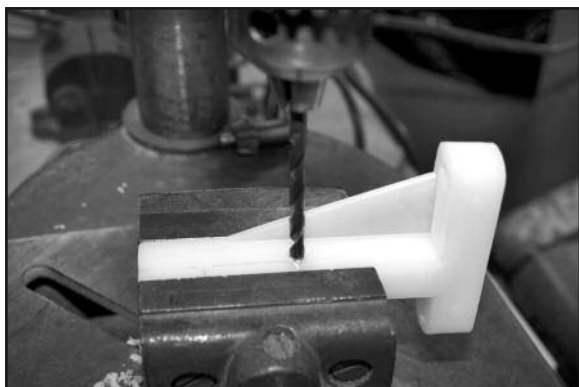

IMPORTANT: DO NOT USE ANY TYPE OF SCREW TO MOUNT YOUR ENGINE TO THESE MOUNTS. ALSO, DO NOT DRILL AND TAP THESE ENGINE MOUNTS FOR BOLTS! Doing so may weaken them and cause failure. Mount your engine to these mounts with steel bolts with flat metal washers and nylon insert lock nuts. Drill clearance size holes for the bolts completely through the mount beams. The mounting bolts should go through the holes without binding.

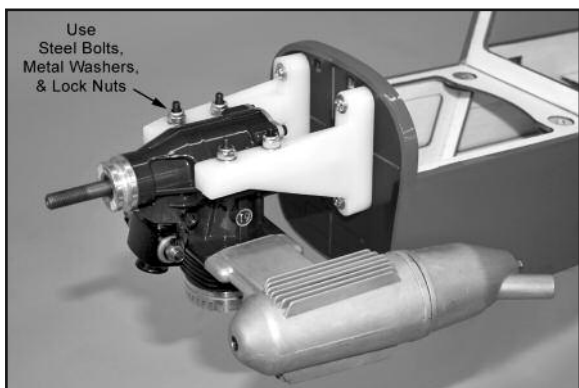

NOTE: Bolts are not provided for mounting your engine because not all engines suitable for the T-CLIPS use the same diameter bolts. Many will use 6-32 size bolts, while some may use a larger diameter bolt. It is up to you to acquire the correct size Bolts(4),

Flat Metal Washers(4), and Lock Nuts(4) to fit your engine. For 6-32 mounting bolts the correct clearance hole would be a 5/32" dia. drill bit.

□ 41) Next assemble the Fuel Tank.

a) Locate the Rubber Stopper Assembly. There are three nylon tubes going through the rubber stopper. Orient the stopper so that one of the tubes is towards the top and then bend that tube up at a 45-degree angle. Do not apply heat to the tube - it will bend without heat. Just overbend it to nearly 90-degrees and then let it relax, to see where it will end up. Repeat if necessary until the tube will stay at 45-degrees.

b) Attach the metal Fuel Pick-Up Weight on one end of the silicone Fuel Line Tubing that goes inside the tank. Cut the other end of the fuel line tubing to a length that will allow the clunk to reach the back of the tank, without getting stuck on the walls of the tank. Test fit in the tank and adjust as necessary. With the stopper assembly in place, the fuel clunk should sit just in front of the rear of the tank and move freely inside the tank. If not pull the assembly back out and trim the tubing back until the stopper moves freely. The top of the vent tube should rest just below the top of the tank. It should not touch the top of the tank.



c) Once you are satisfied with the fit of both the fuel clunk line and the vent line you can tighten the machine screw to expand the rubber stopper and seal the stopper in the tank. Do not over tighten the screw as it can cause the tank to split. Attach three 6-inch lengths of silicone fuel tubing (not furnished) to the tank and label them appropriately as FILL, CARB, and VENT so you can identify them after the tank is installed in the airplane.



□ 42) Install the fuel tank in the fuselage.

a) First glue the plywood fuel tank front mount in the notches in the fuselage floor.

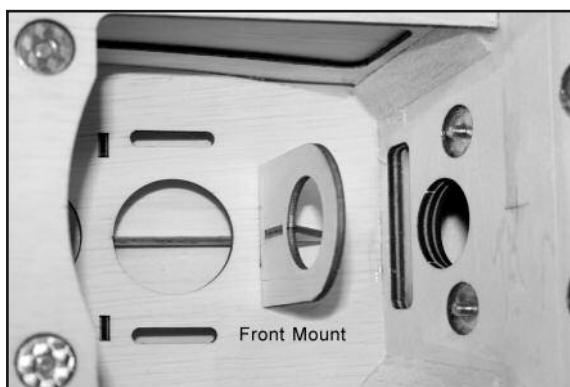

b) Slip the fuel tank in place, poking the neck of the tank into the plywood front support.

c) Now install the plywood fuel tank rear mount at the back of the tank, right up against the back side of the front fuselage former. Glue the plywood rear mount permanently to the back of the fuselage former.

d) Use common silicone bathtub sealer (not furnished) to glue the fuel tank to the front and rear plywood tank mounts.

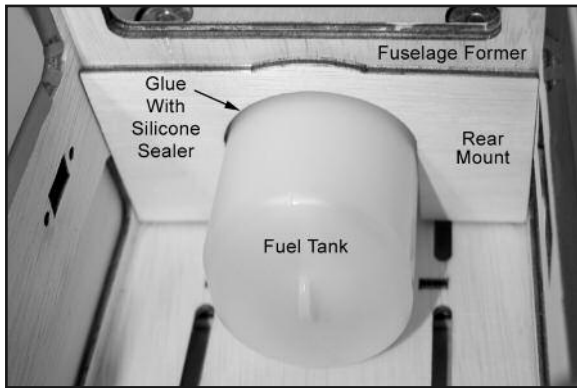

THROTTLE PUSHROD FOR 2-STROKE ENGINES

The supplied throttle pushrod assembly consists of a wire pushrod running inside a nylon pushrod tube. On the threaded end of the pushrod you will have an Metal RC Clevis. For a typical 2-stroke installation we prefer to connect this end of the pushrod to the carburetor arm. The plain end of the pushrod wire will connect to the throttle servo using a Metal Pushrod Connector.

Determine which side of the airplane your throttle pushrod will be on. Then determine the exact route your pushrod will take to connect to the throttle servo and the engine's throttle arm. In most cases you will want the pushrod to run right alongside the engine mount and fuel tank, and then angle over to the throttle servo arm.

□ 43) The first step is to drill a 3/16" diameter hole through the firewall for the throttle pushrod to pass through. Be careful not to drill a hole in your fuel tank!

□ 44) Install your throttle servo in the fuselage.

a) Locate the laser-cut plywood throttle servo mount (this servo mount is not pre-installed in the fuselage). Notice that there is a slot in each side of the fuselage to accept the tab on the plywood throttle servo mount. Glue the plywood mount securely into the fuselage, on the side that suits your particular engine.

b) Mount your throttle servo in the plywood mount using the rubber grommets, eyelets, and screws that came with the servo.

c) Install the metal pushrod connector in the throttle servo arm, with one hex nut above the arm, and one below. You will need to drill out the hole in the servo arm with a 5/64" dia. (or #47) drill bit to accept the threaded portion of the pushrod connector. Tighten the two hex nuts of the pushrod connector securely against the top and bottom of the servo arm. If you take the set screw temporarily out of the pushrod connector, you can use a small screwdriver to go down through the connector body to hold the bolt, which makes it much easier to tighten the hex nuts. When finished, install the throttle servo arm back onto the servo.

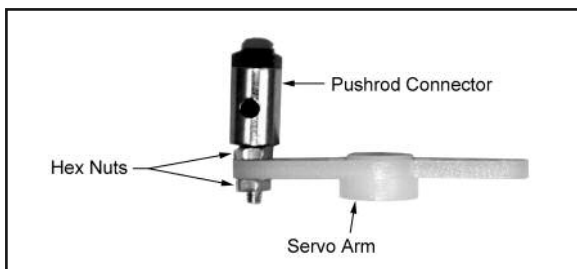

□ 45) Install the throttle pushrod.

a) Start by test fitting the throttle pushrod wire in the airplane,

sliding the plain end of the wire in from the front. Steer the pushrod through the hole you drilled in the firewall; then through the hole in the rear tank mount; and then back to the pushrod connector on the servo. Slide the end of the wire into the pushrod connector, but don't tighten the set screw at this time.

b) Now try to connect the metal clevis at the front of the pushrod to the carburetor arm. With a typical 2-stroke engine you will most likely find that the clevis does not line up with the carburetor arm. If that is the case simply take the pushrod back out of the airplane and use a pliers to bend the end of the pushrod in an offset pattern, as shown below, using two 45° bends. In our installation we needed to offset the end of the pushrod about 3/8" in order to line up directly with the carburetor arm (see photo below).

c) When you are ready to put the pushrod wire back in the airplane for the final time, first slip the nylon throttle pushrod tube over the pushrod wire. After you get the pushrod assembly in the airplane, adjust the location of the nylon tube so approximately 1" of the nylon tube is sticking out in front of the firewall. Then glue the tube to the plywood rear tank support, to keep it from moving. Cut the rear of the plastic tube off a couple inches from the servo arm.

d) Turn on your radio and adjust the length and travel of the throttle pushrod. When done make sure the pushrod fittings are secure at both ends.

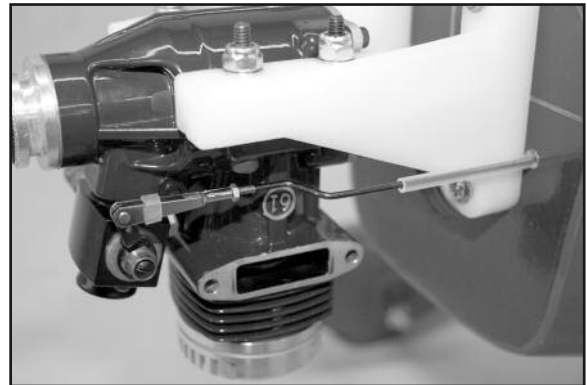

THROTTLE PUSHROD FOR 4-STROKE ENGINES

4-stroke glow engines typically have their carburetor on the back of the engine. This puts the throttle arm very close to the firewall of the airplane, making the hookup of this end of the throttle pushrod more difficult. If you are using a 4-stroke engine you should take a look at some of the special after-market fittings that are available for this type of installation. For instance Du-Bro® makes a 4-stroke throttle linkage for the carb end of the pushrod, that will work well in conjunction with the wire pushrod parts included in this kit.

COWLING

□ 46) Openings will need to be made in the cowling to clear the engine cylinder head and muffler, and to allow access to the needle valve, etc. Don't be tempted to quickly dive in with a knife and

start removing large chunks of material. You will achieve a lot better result if you take the time to develop a pattern and mark it on the cowling for guidance when you are cutting.

There are no hard and fast "rules" for the exact perfect shape for openings in a cowling. The best method is to "sneak up" on these openings, continually trial fitting the cowling over the engine until it finally fits properly. Once the opening is big enough for you to slip it over the engine and place it in correct location on the model, then continue modifying as needed.

A Dremel® Tool, or similar powered hand-tool, with a 5/8" dia. coarse grit sanding drum is without a doubt the best tool to use for removing the material quickly, easily and accurately. However, if you do not have access to such a power tool, you can cut the opening with a drill, a hobby knife, and a file - by first drilling a series of almost touching holes inside your pattern lines (1/8" dia. works well); then using the knife to cut through the connecting material between each hole; and finally finishing the edges of the opening with the file or a sanding block.

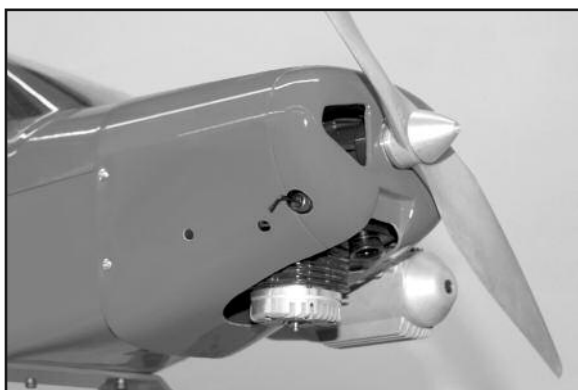

□ 47) Mount the cowl to the fuselage with the four M3 x 10mm Screws provided. Steps 35 and 36 on page 12 of this manual describes mounting the cowling.

LATER ... BEFORE FLYING ... SEAL THE HATCH

When using a glow engine we recommend that you seal the Hatch/Windshield onto the fuselage to prevent fuel and exhaust residue from getting inside the fuselage. The reason we built a removable hatch into this airplane was to provide easy access to the battery compartment when using an electric motor for flight. Obviously, with a glow engine you do not need regular access to this area of the airplane. We recommend tack gluing the hatch in place with several small spots of glue along its edges. Then seal over the seams with either clear tape or white covering material (not supplied). This is reversible if you ever need access to the fuel tank in the future.

INSTALL SIDE WINDOWS

Both glow engine and electric motor users resume assembly here.

□ 48) The clear plastic side windows are molded to fit into the fuselage window frames from the inside. Note that each window has a flange all the way around the outside perimeter to provide a easy gluing surface. You may need to trim the flanges a little closer than the factory did, in order to fit them in place. A sharp scissors or snips works best for trimming the windows.

Glue the windows in place with 5-minute epoxy or RC-56 type glue. **Do not** use thin CA glue because it can cloud the plastic. Apply a thin bead of glue around the edge of the window and press the window in place from the inside of the fuselage. Don't use too much glue or it may ooze out onto the outside surface of the window. Use a few small pieces of low tack tape to hold the window in place until the glue dries.

CONGRATULATIONS!

Your T-CLIPS 70 is completely assembled. However, it is NOT ready for flight! There are a few very critical pre-flight tasks we must perform before flying. These are extremely important and should be approached with patience and care.

PRE-FLIGHT

BALANCE

Balancing your airplane may be the single most important step in preparing it for flight. All airplanes, model or full-size, must be accurately balanced in order to fly successfully. An airplane that is not properly balanced will be unstable and will most likely crash.

NOT ALL T-CLIPS WILL BALANCE THE SAME

It is impossible to produce a model airplane kit that will automatically have the correct balance point. Not everyone uses the same motor or radio gear - and all those items can vary in weight! Even propellers of the same size can vary as much as a 3/4 oz. between different brands. That's why every model must be balanced before flying. Don't feel that whatever the balance point your model came out at is "good enough". Check carefully and make whatever adjustments are required. Trying to fly an out of balance model is dangerous!

Preliminary: All the parts and components that will be in the airplane in flight must be installed in their correct positions. This includes all the radio gear, the propeller, battery pack, etc. Every piece of essential equipment must be installed, ready for flight.

ACCEPTABLE BALANCE RANGE FOR T-CLIPS
is from 3-1/4" to 4-1/8"
AFT OF THE LEADING EDGE OF THE WING

The following table lists several acceptable measurements and the equivalent percent of MAC (Mean Aerodynamic Chord).

<u>DISTANCE</u>	=	<u>% MAC</u>
3-1/4"	=	26%
3-1/2"	=	28%
3-3/4"	=	30%
4-1/8"	=	33%

A balance point approximately 3-1/2" aft of the leading edge (which is at the main wing spar) is ideal for initial test flights. After test flying you can adjust the balance point to fit your flying style.

CONTROL SURFACE TRAVEL

The following control surface data has been flight tested with the T-CLIPS. However these numbers are only recommended as a starting point. Your flying style may dictate changes.

<u>LOW RATE</u>		
Elevator	7/8" up 7/8" down	35%-50% expo
Ailerons	7/16" up 7/16" down	35%-50% expo
Rudder	1-1/4" right 1-1/4" left	25%-40% expo
<u>HIGH RATE</u>		
Elevator	1-1/2" up 1-1/2" down	55%-70% expo
Ailerons	3/4" up 3/4" down	55%-70% expo
Rudder	2" right 2" left	50% expo

FLYING

When it comes to test flying a new model, we always advise modelers to choose a calm day with little or no wind. These conditions allow you to better evaluate and more accurately adjust the trim requirements for your airplane. As we've mentioned before, a good running, reliable motor is a must for the ultimate success of your airplane. Take the time to solve any power system problems before you try to fly.

Always make it part of your pre-flight routine to check each control on the airplane, making sure the surfaces are moving in the correct directions. Also check each control linkage to be sure they are secure and that nothing is loose. With all the controls checked, make a range check with your radio system, making sure everything is working perfectly.

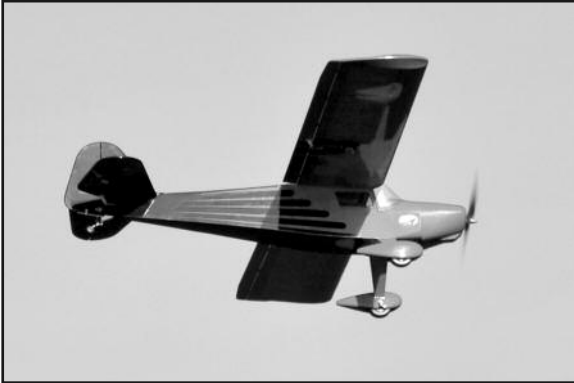

We hope that your T-CLIPS will provide you with many enjoyable hours of flight. Good luck and safe flying!

THE "T-CLIPS" STORY

"T-CLIPS" is the name given to a one-of-a-kind clipped wing Taylorcraft owned and flown by air show pilot Erik Edgren. Beginning life in 1939 as a stock Taylorcraft Model BC-65, Erik's "T-CLIPS" is powered by Continental C-85 engine, which was an original Taylorcraft factory option. That makes "T-CLIPS" the only clipped wing T'craft currently flying air shows with an original size engine. Erik refers to this as "Twistin It Old School".



"T-CLIPS" owner and air show pilot Erik Edgren.
(photo from October 2009 SPORT AEROBATICS magazine)



Learn more at

www.ErikEdgrenAirshows.com

WARNING! THIS IS NOT A TOY!

Flying machines of any form, either model-size or full-size, are not toys! Because of the speeds that airplanes must achieve in order to fly, they are capable of causing serious bodily harm and property damage if they crash. **IT IS YOUR RESPONSIBILITY AND YOURS ALONE** to assemble this model airplane correctly according to the plans and instructions, to ground test the finished model before each flight to make sure it is completely airworthy, and to always fly your model in a safe location and in a safe manner. The first test flights should only be made by an experienced R/C flyer, familiar with high performance R/C aircraft.

JOIN THE AMA

The governing body for radio-control model airplanes in the United States is the ACADEMY OF MODEL AERONAUTICS, commonly called the AMA. The AMA SAFETY CODE provides guidelines for the safe operation of R/C model airplanes. While AMA membership is not necessarily mandatory, it is required by most R/C flying clubs in the U.S. and provides you with important liability insurance in case your R/C model should ever cause serious property damage or personal injury to someone else.

ACADEMY OF MODEL AERONAUTICS
5161 East Memorial Drive
Muncie, IN 47302
Telephone: (765) 287-1256
AMA WEB SITE: www.modelaircraft.org

CUSTOMER SERVICE

SIG MFG. CO., INC. is committed to your success in both assembling and flying the T-CLIPS ARF. Should you encounter any problem building this kit or discover any missing or damaged parts, please feel free to contact us by mail or telephone.

SIG MFG. CO., INC.
P.O. Box 520
401 South Front Street
Montezuma, IA 50171-0520

PHONE: 1-641-623-5154
FAX: 1-641-623-3922

SIG WEB SITE: www.sigmf.com
SIG E-MAIL: mail@sigmf.com

LIMIT OF LIABILITY

The craftsmanship, attention to detail and actions of the builder/flyer of this model airplane kit will ultimately determine the airworthiness, flight performance, and safety of the finished model. SIG MFG. CO.'s obligation shall be to replace those parts of the kit proven to be defective or missing. The user shall determine the suitability of the product for his or her intended use and shall assume all risk and liability in connection therewith.