

ASSEMBLY MANUAL



KADET SENIORITA *Sport*

KIT NO. SIGRC109EPARF



ALMOST READY TO FLY

SPECIFICATIONS

Wing Span:	65 in.	(1651 mm)
Wing Area:	800 sq. in.	(51.6 dm ²)
Length:	54.7 in.	(1389 mm)
Flying Weight:	4.8 - 5.0 lbs.	(2177 - 2268 g)
Wing Loading:	13.8 - 114.4 oz./sq.ft.	(42-44 g/dm ²)

Radio: 4-Channel with 4 Standard Servos

Electric Power: Brushless Outrunner Motor
(400-700w; 700-1000kv; 35-42 mm case dia.)
45-75A Speed Control (ESC)
3-4s 3000-4000 mah Lipo Battery Pack



SIG MFG. CO., INC. PO Box 520 Montezuma, IA 50171-0520
www.sigmfg.com



KADET SENIORITA Sport

KIT NO. SIGRC109EPARF



ASSEMBLY MANUAL

Congratulations on your purchase of the KADER SENIORITA SPORT ARF. The SIG KADET SENIOR series of airplanes has a long and illustrious history in R/C flying. It originally came on the scene in the early 1980s, designed by AMA Hall of Fame modeler Claude McCullough. The KADET SENIOR rapidly earned a reputation as the easiest to fly R/C trainer in the world, and a relaxing sport model. Shortly thereafter a smaller version, called the KADET SENIORITA, was introduced. Over the years, tens of thousands of newcomers have successfully learned to fly R/C with a KADET SENIOR.or SENIORITA.

This almost-ready-to-fly version of the KADET SENIORITA is 100% true to the original's outstanding flying characteristics. The change to a taildragger landing gear and large barndoor style ailerons makes this version of the SENIORITA a sporty aerobatic everyday airplane.

Assembly of your KADET SENIORITA SPORT is fast and simple when following the detailed instructions in this manual. We urge you to read this assembly manual completely before assembly. Familiarize yourself with the parts and the assembly sequences. The successful assembly and flying of this airplane is your responsibility. If you deviate from these instructions, you may wind up with problems later on.

We hope you will enjoy this legendary R/C model. We're confident you will love the way it flies! Let's get started!

If this is your first R/C Aircraft PLEASE READ THIS!

As already mentioned, the KADET SENIORITA ARF is a perfect model for learning to fly R/C. However, it is important to understand that if you have never flown an R/C model before, you will need to find a qualified R/C flight instructor to test fly the airplane and teach you how to fly it. If this is your first radio control model airplane, **DO NOT** attempt to fly it by yourself without a qualified instructor.

ADDITIONAL ITEMS YOU WILL NEED TO PURCHASE

In addition to this kit, you will need the following items to complete your KADET SENIORITA and make it flyable.

□ RADIO SYSTEM

The KADET SENIORITA requires a standard 4-channel radio system and four standard servos. In addition, you'll need two 6"-12" long Servo Extension Chords, and one standard Y-Harness Chord, for connection of the two aileron servos to the receiver. The actual length of the extension chords you will need depends on how long the wires are coming off your servos - be sure to double check your servos and plan accordingly,

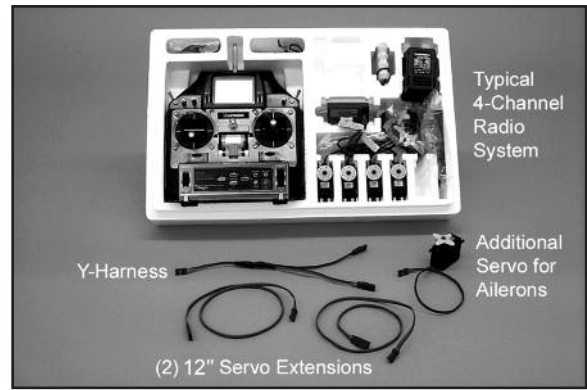

ELECTRIC POWER RECOMMENDATIONS

□ 600 - 700 watt BRUSHLESS OUTRUNNER MOTOR

The KADET SENIORITA SPORT is designed for brushless outrunner electric motors rated for approximately 400 to 700 watts output. While this range is quite wide, it illustrates the versatility of the KADET's light wing loading. This airplane can fly with minimal power for realistic flight, or with extra power for load carrying chores and more aerobatic performance. Also, the motor you choose should be rated at 700-1000 KV, in order to turn an appropriate size propeller.

Another good measure of brushless electric motors is the common 7-digit system of actual motor dimensions, followed by a hyphen, followed by the KV rating.

Here is a sampling of motor sizes that work well in the KADET SENIORITA using the numbering system:

3522-990	400w	(Himax)
3528-1000	500w	(Himax)
3554-870	550w	(E-Flite Power 25)
4240-1000	650w	(GP Rimfire 25)
4250-770	700w	(E-Flite Power 32)

What do those numbers mean?

3522 - 990

CASE DIA. KV CASE LENGTH

X MOUNT

NOTE: This numbering system is very common, however there are exceptions. For instance, some motor manufacturers will list the actual diameter of the stator (armature) inside the motor instead of the case diameter. Some may list the length of the stator inside the motor instead of the case length. Some will give you both if you dig far enough into their specs. Make sure you understand the motor manufacturer's numbering system when shopping for a motor.

□ MOTOR MOUNT

A laser-cut plywood motor mount built onto the front of the fuselage is adjustable in length to accommodate the length of your particular motor. It should work perfectly for any suitable brushless outrunner motor which has an "X" or "cross" motor mount plate on the back.

□ 45-75 amp ESC (Electronic Speed Control)

Use an ESC that is rated for the maximum amps that your motor will possibly draw - refer to the motor manufacturer's specifications

for your particular motor. Make sure the ESC is designed for a "brushless" motor. Most ESCs suitable for the KADET SENIORITA will also have a built-in BEC (Battery Eliminator Circuit).

Important Note: BEC allows you to use the same battery pack to power both your motor and your radio system, eliminating the normal radio battery pack. When the single battery pack runs down in flight to a prescribed point, the BEC circuit in the ESC will shut down the motor and leave enough power to operate the radio while you land the model. Note that the BEC feature in some cheaper ESCs does not work with 4 cell and larger lipo battery packs - only 3 cell packs. Check carefully to make sure you know all the specifications of the ESC that you are buying.

3 to 4 cell 3200-4000mah LIPO BATTERY PACK

Electric motors commonly used in the KADET SENIORITA will typically require a 3 or 4 cell lipo battery pack, depending on the motor's design. Refer to the motor manufacturer's instructions for guidance. We've found that the motors with a 35mm dia. case will often perform well with a 3 cell pack. Motors with a 42mm dia. case will typically use a 4 cell pack. Some motors can use either size. The capacity of the lipo battery pack will usually range from 3200 to 4000 mah for adequate duration.

PROPELLER FOR ELECTRIC

With electric powered models there are many factors that have a bearing on what propeller to use. The best place to start answering that question is in the instructions that come with your motor. Another fine source of information is one of the electric flight calculators that are available for you to use free online (there is a good one on Castle Creations web site).

CAUTION: You must match your propeller size to your motor and to the cell count of your lipo pack, to avoid drawing too many amps and damaging your ESC or motor.

OUR FLIGHT TEST REPORT

After extensive test flying, our favorite setup for the KADET SENIORITA is the Himax 3522-990 (990 KV) brushless motor, with a 45 amp ESC, 3S 3300 mah lipo battery pack, and an APC 10x7E propeller. This combination gave outstanding flight performance with flight times in excess of 10 minutes, depending of course on throttle management. Your results may vary. For more flight time use a larger mah capacity pack. Prop size, size and quality of the battery pack, throttle management, air temperature, etc., all have a bearing on electric flight performance and flight time. Experiment to find the best combination for your setup.

BATTERY CHARGER

FOR SAFETY AS WELL AS PERFORMANCE, CHARGE LIPO BATTERIES ONLY WITH A LIPO BATTERY CHARGER!

In addition to providing the critical charging profile needed to safely charge lipo batteries, a lipo battery charger also includes the capability of "balancing" the available voltage in the cells, ensuring that the battery pack is at peak capacity at the end of the charge cycle. This translates to better flight times and a longer life from the battery pack.

REQUIRED TOOLS

For proper assembly, we suggest you have the following tools and materials available:

A selection of glues - SIG Thin, Medium, & Thick CA Glue
CA Accelerator, CA Debonder
SIG Kwik-Set 5-Minute Epoxy

Screwdriver Assortment

Pliers - Needle Nose & Flat Nose

Diagonal Wire Cutters

Small Allen Wrench Assortment

Pin Vise for Small Dia. Drill Bits

Hobby Knife with Sharp #11 Blades

Small Power Drill With Selection of Bits

Dremel® Tool With Selection of Sanding & Grinding Bits
Scissors
Sandpaper
Heat Iron & Trim Seal Tool
Masking Tape
Paper Towels
Alcohol and/or Acetone For Epoxy Clean-up

COMPLETE KIT PARTS LIST

The following is a complete list of all parts contained in this kit. Before beginning assembly, we suggest that you take the time to inventory the parts in your kit. Use the check-off boxes (q) provided in front of each part description.

- (1) Fuselage
- (1) Right Wing Panel & Aileron, hinges not glued
- (1) Left Wing Panel & Aileron, hinges not glued
- (1) Horizontal Stabilizer & Elevator, hinges not glued
- (1) Vertical Fin & Rudder, hinges not glued
- (1) Fiberglass Cowling

Main Landing Gear

- (1) Aluminum Main Landing Gear; painted white
- (2) 2-1/2" dia. Main Wheels
- (2) 4mm dia. x 48mm Axles
- (4) 5mm Hex Nuts; for axles
- (4) 4mm ID Wheels Collars; for axles
- (1) Right Fiberglass Wheel Pant; painted white
- (1) Left Fiberglass Wheel Pant; painted white

Tailwheel

- (1) Tailwheel Assembly, including Wheel, formed Wire, Nylon Bearing, and Wheel Collars(2)
- (2) M3 x 12mm Screws

Control Horns

- (4) Nylon Control Horns; for ail(2), ele(1), rud(1)
- (2) Nylon Control Horn Retaining Plates; for ele(1), rud(1)
- (12) M2 x 16 mm Screws; for control horns

Pushrods

- (2) 35-1/2" long Wire Pushrods, threaded on one end, including M2 Hex Nuts(2); for elev. & rud.
- (2) 7" long Wire Pushrods, threaded on one end, including M2 Hex Nuts(2); for ail.

Miscellaneous

- (1) 1-3/4" dia. Spinner
- (2) M2 x 10mm Screws; for spinner
- (1) 16mm OD x 335 mm Aluminum Tube Main Wing Joiner
- (2) Plastic Cinch Straps
- (2) Velcro® Straps
- (2) M6.5 x 45 mm Nylon Wing Bolts
- (2) Molded Clear Plastic Front Side Windows
- (1) Molded Clear Plastic Rear Side Windows, Right
- (1) Molded Clear Plastic Rear Side Window, Left
- (4) M4 x 16mm Socket-Head Mounting Bolts; for motor
- (4) M4 Split-Ring Lock Washers; for motor
- (4) M4 Blind Nuts; for motor
- (3) M4 x 20mm Socket-Head Bolts, for main landing gear
- (3) M4 Flat Washers, for main landing gear
- (4) M3 x 9mm Sheet Metal Screws, for cowling
- (4) M3 x 10mm Socket-Head Bolts, for wheel pants
- (4) Metal Clevis; for ail(2), ele(1), rud(1)
- (4) small pieces of Fuel Tubing; for clevis keepers
- (4) Pushrod Snap Keepers; for ail(2), ele(1), rud(1)
- (1) Balsa Triangle Stock; for motor mount reinforcement

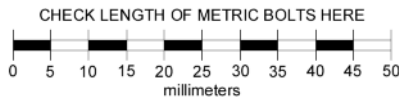

COVERING MATERIAL

Your KADET SENIORITA ARF is covered with Oracover®, a premium quality covering made in Germany, and sold in the U.S. by Hanger-9 as Ultracote®

Colors

Oracover® #10 White (Ultracote® #HANU870)
and

Oracover® #29 Transparent Red (Ultracote® #HANU950)
or

Oracover® #59 Transparent Blue (Ultracote® #HANU954)

If sometime in the future you need replacement covering or matching paint for repairs, they are available from your local hobby dealer or online from Hanger-9.

How To Tighten Loose Covering

After you open your KADET SENIORITA and take all the covered parts out of their plastic bags the covering may begin to wrinkle. This is not unusual and is no cause for alarm.

Your airplane was built and covered in a part of the world which has relatively high humidity and therefore, the wood was likely carrying a fair amount of moisture. When exposed to drier air, the wood typically loses this moisture, dimensionally "shrinking" in the process. In turn, this may cause some wrinkles. However, wrinkles are easy to remove by just using a hobby type heat iron. Caution: Trying to remove the wrinkles by hastily going over them with a heat gun can lead to more problems. You should take your time to carefully go over the entire model with a covering iron, as we will describe.



We suggest using a model airplane covering iron for this process. Cover the iron's shoe with a thin cotton cloth, such as an old t-shirt, to prevent scratching the covering as you work.

After covering your iron, the next step is to set the iron to the correct temperature. This is critical for achieving a good result! The iron should be set to about **220°F - 250°F (104°C - 121°C)** as measured on the bottom of the iron using a thermometer.

If you do not have a thermometer, you can find the correct temperature by trial and error. Set your iron to a medium setting. Glide the iron over some of the covering that is over over solid wood, such as the sheeted wing center section. Observe the covering to see if any bubbles appear. If bubbles appear, the covering is getting too hot! Turn down the temperature of the iron. If no bubbles appear, turn up the heat slightly and repeat the test. Keep adjusting until you "zero in" on the correct temperature. Find the temperature that will get the covering to stick down without forming bubbles or causing the seams to pull away.

Once your iron is set to the correct temperature, go over the entire framework of the airplane, making sure that the covering is securely bonded to the structure everywhere the covering comes in contact with the wood underneath. This takes some time, but is worth the effort.

After you have all the covering secured onto the solid areas, turn the temperature of the iron up to approximately **300°F - 320°F (149°C - 160°C)**. This is the correct temperature for shrinking the covering material.

Use the iron to tighten up any wrinkles in the "open" areas of the model (no wood underneath the covering). Glide the iron over the wrinkle for a few seconds, then remove. Repeat until the covering is tight with no wrinkles.

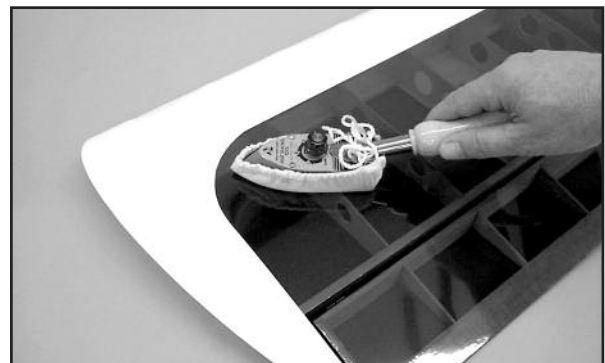

If wrinkles keep coming back on the tail surfaces, you may need to "ventilate" the areas between the ribs. Otherwise the air that is sealed in those relatively small areas will expand when the heat is applied and actually cause the covering to stretch instead of shrink. Use a pin to poke a tiny hole in the covering between each rib, on the bottom of the part. That will let the expanding air escape and the covering to shrink properly.

Caution When Using Heat Guns: You can also use a hobby-type heat gun to shrink the covering, but you must be careful around seams or color joints. Getting too much heat on the seams may cause them to "creep" or come loose. You must also be careful when using a heat gun when working around the windshield and side windows - heat will distort the clear plastic material.

Recommended Temperatures:

To adhere the covering - 220°F - 250°F (104°C - 121°C)
To shrink the covering - 300°F - 320°F (149°C - 160°C)

MODELER'S TIP: One of the most common problems associated with shrinking any covering film is controlling the heat around the seams. Heat applied too close or directly onto seams re-heats the covering adhesive and the seams will often "crawl". This is easy to control. Just tear a few paper towels into strips and soak them in cool tap water. Lay the wet strips over the covering and use a heat gun or iron as you normally would. The wet strips keep the seam cool while the covering immediately next to it shrinks. This tip workS great with any iron-on covering.

NOTE: In this manual, any references to right or left, refer to your right or left as if you were seated in the cockpit of the airplane.

WING ASSEMBLY

The wings are designed as a 2-piece system, with separate right and left wing panels joined by an aluminum tube wing joiner and a hardwood locating pin at the rear. Due to the high strength of the wing joiner tube, the wing panels do not need to be permanently glued together. Gluing them permanently together is optional - your call. The obvious benefit to leaving the wing panels separate is the fact that they can be easily transported or stored.

To help protect your wings during the following steps we recommend that you cover your work surface with a soft cloth or piece of soft cell foam.

INSTALLING THE AILERON SERVOS

For the following steps you will need:

- (1) Right Wing Panel
- (1) Left Wing Panel
- (1) Aluminum Tube Wing Joiner
- (2) Servos with Mounting Screws (not furnished)
- (2) Servo Extension Chords (not furnished)
- (1) Servo Y- Harness (not furnished)

- 1) Mount the aileron servos in the bottom of each wing panel.
 - a) The servo bays are precut for you but you'll want to double check the covering around the cutout to make sure it is sealed down tight.
 - b) Install the rubber grommets and brass eyelets (supplied with your radio system) into each aileron servo.
 - c) Install the control arms on the two aileron servos. The arms should be at 90 degrees to the servo when the aileron control stick on the transmitter is in neutral and the transmitter trims are in neutral as well.
 - d) Before installing the aileron servos in the wing panels you must attach a servo extension chord to each of the aileron servo wires. Plug the servo plug into the extension chord and tape the plugs together for added security.

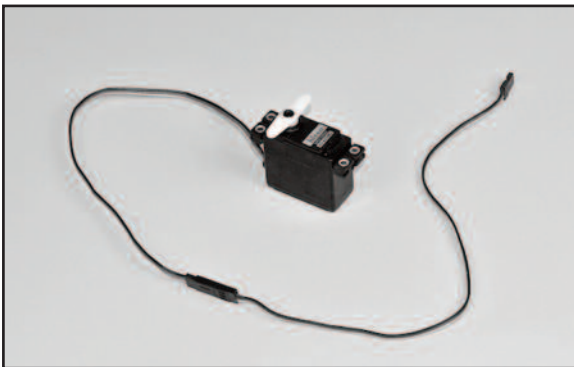

- e) A string is provided in the wing panel for pulling the aileron servo chord through the wing. Each end of the string is taped on the outside of the wing panel. Carefully untape the string at the servo opening and tie the end of the string securely to the end of the servo wire, as shown.



- f) Untape the string at the root end of the wing panel and begin carefully pulling the string and the aileron chord through the wing. You will occasionally feel like the wire has become stuck inside the wing. This is simply the plug on the end of the servo wire hitting the side of one of the holes in the wing ribs. Gently work the string back and forth until the plug slips through the hole. Sometimes the servo plug comes through all the ribs the first time without getting hung up, and other times it seem like it gets hung up on every rib. Be patient and don't try to force it.

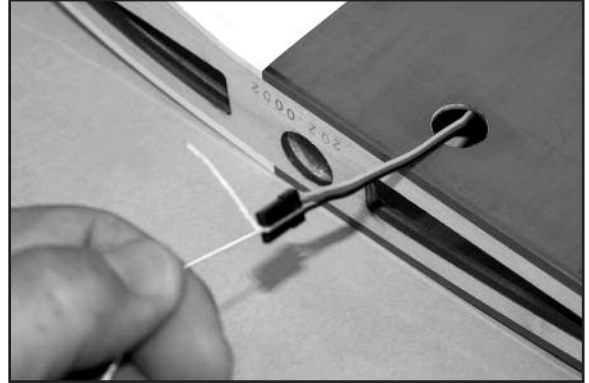

- g) Repeat this step to pass the other aileron servo wire through the other wing panel.
 - h) Fit the servo into the servo mount in the wing panel, (note that the servo is positioned so that the servo arm is at the forward end toward the wing leading edge). Take up any slack in the servo chord as you insert the servo in the mount. Use a pin vise and a small drill bit to drill small pilot holes in the servo mount for the servo mounting screws. Use the screws supplied with your radio system to mount the servo in place on the servo mount. Repeat this procedure to mount the servo in the opposite wing panel.

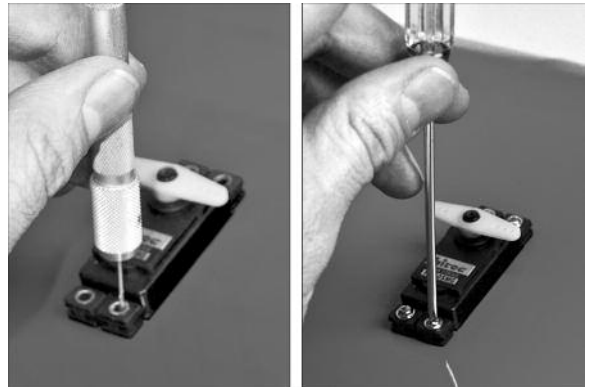

HINGING THE AILERONS

- 2) Note that the CA Hinges are installed, but not yet glued, in the ailerons and wing panels. The installation process for the hinges is the same for all of the control surfaces on this model.
 - a) If you removed the ailerons and hinges from the wing panels when you tightened the covering material, reinstall them now. First insert the three CA Hinges into the slots in the aileron. Put two pins in the center of each hinge, up against the leading edge of the aileron, to keep the hinges centered during the next step.

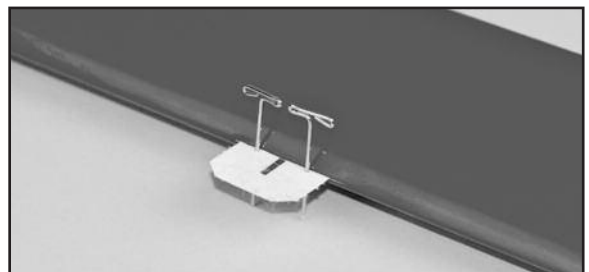

b) Now carefully insert the exposed portion of the three hinges into the trailing edge of the wing. You will find it easiest to slide the hinges into the slots at angle, one hinge at a time, instead of trying to push it straight onto all the hinges at once.

c) Adjust the aileron so that the tip of the aileron is flush with the wing tip. The ailerons should be tight against the pins in the hinges to minimize the gap between the wing and the aileron. The aileron is now in the proper position for permanently gluing them in place with thin CA glue.

d) Flex the aileron down and hold it in this position. Remove the pins from one hinge and then carefully apply 3-4 drops of Thin CA glue directly onto the hinge in the gap. You will notice that the glue is quickly wicked into the slot as it penetrates both the wood and the hinge. We suggest using a fine tipped applicator on the glue bottle to better control the flow of glue.



e) Turn the part over and glue the other side of the hinge. Continue this process until you have glued both sides of all the hinges! Keep a rag handy to wipe off any excess Thin CA glue. (If you get some glue smears on the plastic covering, don't worry about them right now. Once all the hinging is done, you can clean the smears off the covering with CA Debonder).

f) Let the glue dry 10-15 minutes before flexing the hinges. At first you might notice a little stiffness in the joint. This will go away after the hinges have been flexed back and forth a couple dozen times.

INSTALL AILERON CONTROL HORNS & PUSHRODS

From the kit contents locate:

- (2) Nylon Control Horns (without retaining plates)
- (6) M2 x 16 mm Screws
- (2) 7" long Pushrod Wires with M2 Hex Nut
- (2) Metal R/C Clevis
- (2) Pushrod Snap Keepers
- (2) small pieces of Fuel Tubing

□ 3) Mount the Nylon Control Horns on the bottom of the ailerons.

a) Look closely and you will see three holes pre-drilled in the bottom of the ailerons for mounting the nylon control horns. Screw a M2 x 14mm screw into each hole. Screw them all the way in, and then screw them all the way back out. This creates threads in the hardwood block in the ailerons. With the screws removed, put one drop of thin CA glue into each hole. Let dry before proceeding. This hardens the threads for long life.

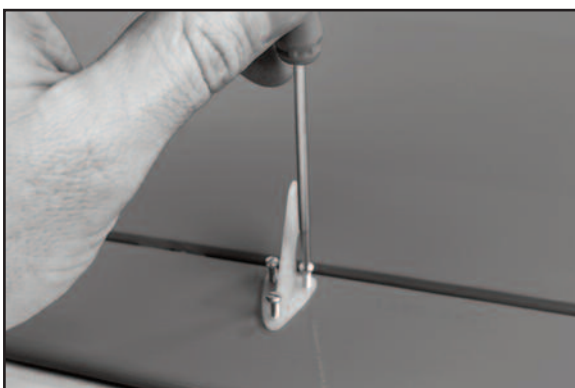

b) When dry, mount the control horn in position on the bottom of the aileron with the screws. Do the same for the other aileron.

□ 4) Next assemble and install the aileron pushrods.

a) Slide a short piece of Fuel Tubing onto the small end of the Metal R/C Clevis. Screw the Hex Nut onto the Aileron Pushrod Wire all the way up to the end of the threads. Then screw the metal clevis halfway onto the threaded end of the Aileron Pushrod Wire.

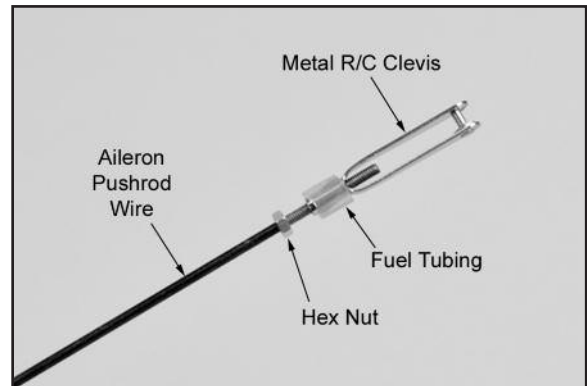

b) Clip the metal clevis into the last hole in the nylon control horn. Lay the other end of the pushrod wire over the outer hole in the servo arm. Use a felt tip pen to mark the wire where it crosses the hole. Use a pair of pliers to put a sharp 90-degree bend in the wire at the mark.

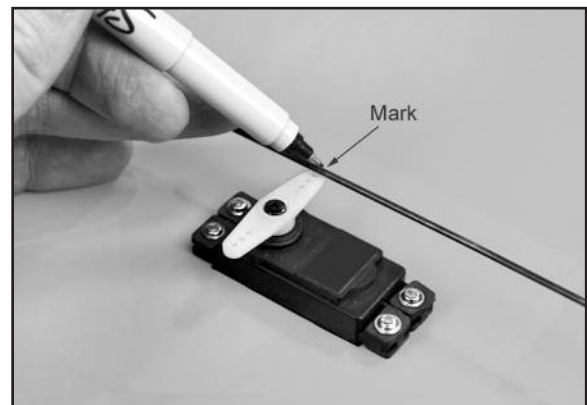

c) Insert the bent end of the pushrod into the servo arm, from the top. Note: You will most likely need to use a 1/16" dia. drill to open the hole in the servo arm to accept the pushrod wire.

d) Mark and cut off the excess end of the pushrod wire, leaving 1/8" of wire protruding below the bottom of the servo arm.

e) Clip a Nylon Snap Keeper in place on the servo end of the pushrod wire. Snap the free end of the keeper up and over the protruding end of the pushrod wire, underneath the servo arm.

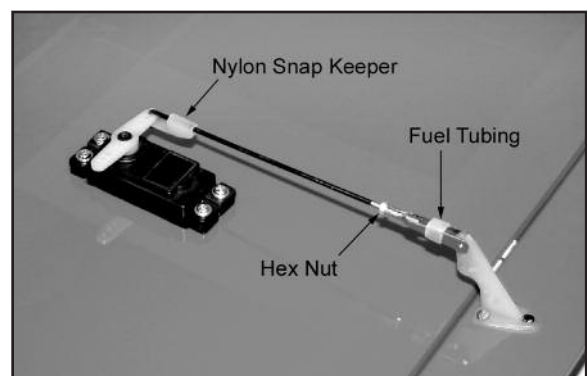

f) Check that the aileron servo is in neutral position and adjust the metal clevis as needed to get the aileron in neutral position.

g) Once the ailerons are properly adjusted, insure that the metal clevis can't open up and come loose from the control horn by sliding the piece of Fuel Tubing over the arms of the clevis. Also tighten the M2 Hex Nut up against the back of the clevis.

□ 5) Test fit the two finished wing panels together with the Aluminum Front Wing Joiner Blade and the Steel Rear Wing Joiner Pin. Then test fit the wing assembly on the fuselage. The tab that is formed by the two panels at the center, leading edge, fits into the cutout in the front fuselage former. At the rear, two M6.5 nylon wing bolts secure the wing to the fuselage. If you encounter any difficulties mounting the wing to the fuselage, find the problem and fix it now. Then remove the wing from the fuselage and set it aside.

FUSELAGE ASSEMBLY

INSTALL THE MAIN LANDING GEAR

Locate the following parts from the kit contents:

- (1) Fuselage
- (1) Aluminum Main Landing Gear
- (3) M4 x 20 mm Socket-Head Bolts
- (3) M4 Flat Washers
- (2) 2-1/2" dia. Main Wheels
- (2) 4 mm dia. Threaded Axles
- (4) 5 mm Hex Nuts; for axles
- (4) 4 mm ID Wheels Collars; for axles
- (1) Right Fiberglass Wheel Pant
- (1) Left Fiberglass Wheel Pant
- (4) M3 x 10 mm Socket-Head Bolts

NOTE: We suggest you use a thread locking liquid (like Loctite®) on all bolts and nuts used in the assembly of the landing gear.

□ 6) Install a Threaded Axle into the large hole of the landing gear leg, with the plain end of the axle shaft pointing to the outside. Secure the axle with the 7.6mm Hex Nut. When tightening the nut, keep the flats of the hex nut on the axle side of the gear leg parallel to the front edge of the leg - see photo. This allows the hex nut to fit inside the narrow notch in the wheel pants when they are added later.

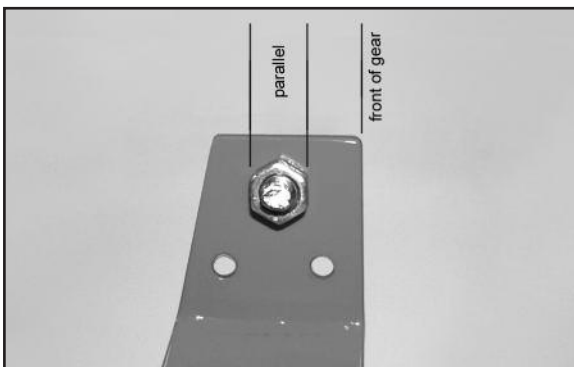

□ 7) Slide a 4mm Wheel Collar onto the axle shaft, but leave approximately 1/8" of space between it and the nut, to provide proper

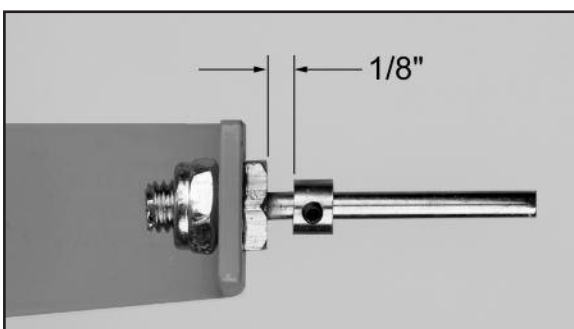

spacing of the wheel in the wheel pant. Tighten the wheel collar set screw securely.

□ 8) Slide the wheel on the axle and test to make sure it spins freely on the axle. Next slide one of the Main Wheels onto the axle and test to make sure it spins freely. If it does not turn freely, drill out the plastic hub of the wheel with an 11/64" or #17 drill bit.

□ 9) Slide a second wheel collar onto the axle and up to the wheel. Leave a small gap between it and the wheel, so the wheel will turn freely, and then tighten the wheel collar set screw.



□ 10) Check the orientation of the landing gear to make sure you know which way is forward. The two outer holes for mounting the gear to the fuselage go to the front. Then test fit the wheel pants over the wheels and line up the predrilled mounting holes. Secure the wheel pants in place with two M3 x 10mm socket head bolts for each pant. (You may need to clean a little paint out of the blind nuts inside the wheel pants in order to start the mounting bolts. A #11 hobby knife works well for this.)



□ 11) Attach the landing gear to the bottom of the fuselage using three M4 x 20mm Socket-Head Bolts and three M4 Flat Washers.

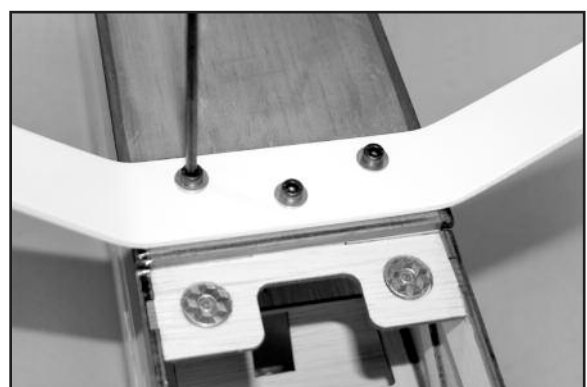

TAIL SURFACE & TAILWHEEL INSTALLATION

For the following steps you will need:

- (1) Fuselage
- (1) Wing
- (1) Stabilizer & Elevator set
- (1) Vertical Fin & Rudder Set
- (2) M6.5 Nylon Wing Bolts
- (1) Tailwheel Assembly
- (2) M3 x 12 mm Screws
- (2) Nylon Control Horns with Retaining Plates
- (6) M2 x 16 mm Screws

□ 12) Remove the elevator and hinges from the stabilizer and elevator, and set them aside for now. Test fit the stabilizer on the fuselage. Notice that the covering has been removed from both the fuselage and horizontal stabilizer where they will mate together. Eyeball the location of the horizontal stabilizer and pin it temporarily in place.



□ 13) Bolt the wing in place on the fuselage with the Nylon Wing Bolts provided. Carefully check the alignment of the stabilizer to the wing.

a) First view the model from directly in front. Check to see if the stabilizer is level with the wing. You should find it to be very close. If necessary use a sanding block to fine tune the stabilizer platform to level the stabilizer to the wing.

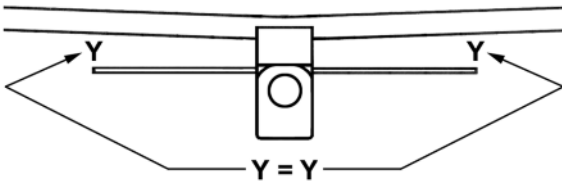

b) Next use a tape measure to measure the distance from each stab tip to the back edge of the wing - the distance should be equal on both sides. Adjust if necessary.

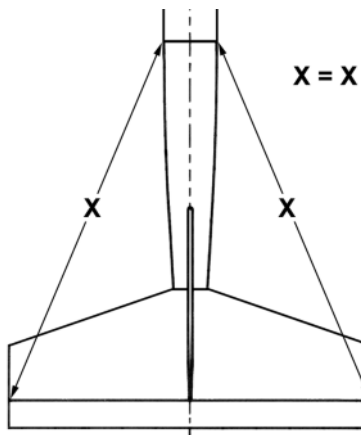

c) Use a fine line felt tip pen to mark some guide lines on the stabilizer that will make it easy for you to realign the stab after the glue is applied in the next step. You can now remove the pins and take the stabilizer off the fuselage for gluing.

□ 14) The horizontal stabilizer can now be glued permanently onto the rear of the fuselage. We suggest using slow drying epoxy glue for this job to allow time to position the stab accurately and make any final adjustments that might be needed. Apply the glue to both sides and reset the stab in place. Use pins to hold it in place. Re-check the alignment. Wipe away any excess epoxy with rubbing alcohol and a soft paper towel. Allow the glue to dry.

□ 15) Pull the Fin and Rudder apart set the rudder and hinges aside for now. Test fit the fin in place on top of the stabilizer. Check to see that the fin sits flush and perpendicular to the stabilizer. When satisfied with the fit, glue the fin in place using slow drying epoxy glue. Apply a coat of glue to the bottom of the fin and to the exposed wood on the stab. With the fin in place, sight the model from the front to make sure the fin is absolutely 90 degrees upright to the stab. If needed, use masking tape to hold it in alignment until dry. Wipe off any excess glue rubbing alcohol and a soft paper towel. Let dry.

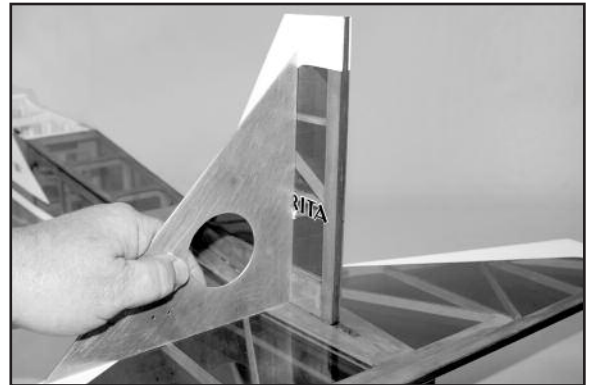

□ 16) Next we will mount the Tailwheel Assembly in place on the lower rear end of the fuselage.

a) Begin by inserting the top (short) leg of the tailwheel wire into the hole in the bottom of the fuselage.

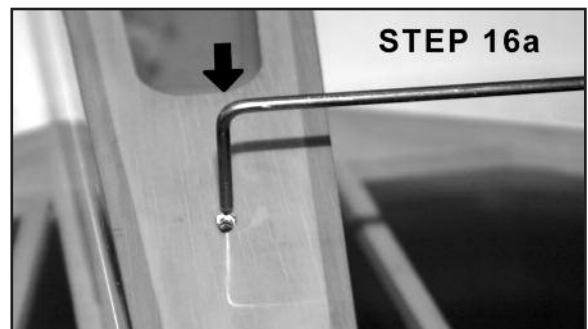

b) When you get to the 90 degree bend, rotate the wire up so you can continue to slide the long shank of the wire inside the fuselage.

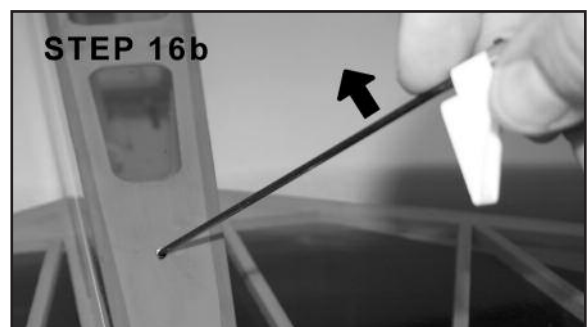

c) Keep sliding the wire in until the short top leg exits the slot in the stabilizer.

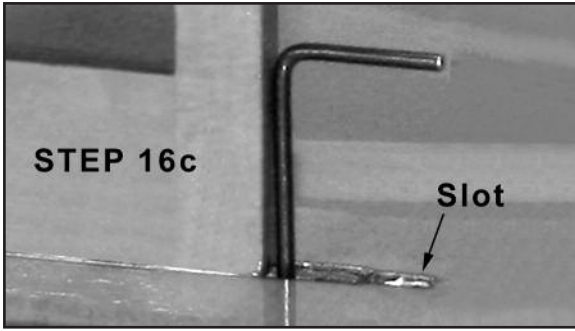

d) Hold the nylon tailwheel bearing in place on the bottom of the fuselage. Mark the mounting hole locations and then drill 1/16" dia. pilot holes in the fuselage. Then screw the bearing in place with the two M3 x 12mm Screws provided.

e) Leave the wheel collar that is between the bearing and the coil in the wire loose for now.



□ 17) Now it's time to install the rudder permanently.

a) Note that the bottom leading edge of the rudder is already grooved and drilled to accept the tailwheel steering wire. Trial fit the rudder onto the wire and up against the back of the fin. Be sure to have the top of the rudder even with the top of the fin - at this point the wire should be able to move up or down slightly as necessary, since the wheel collar has not been tightened.

b) Take the rudder back off the wire and insert the CA Hinges back into the slots in the rudder leading edge.

c) Mix up a small batch of epoxy glue and apply it in the groove and hole in the rudder for the tailwheel wire.

d) Carefully insert the front side of the three CA Hinges into the hinge slots in the back of the fin, while at the same time inserting the tailwheel wire into the rudder. Watch for any excess epoxy glue that may ooze out of the wire slot and wipe it off with a rag soaked in rubbing alcohol. When you've got the rudder all the way on, double check that the top of the rudder lines up with the top of the fin.



e) Finish the rudder installation by gluing the CA Hinges in place with Thin CA, using the same techniques you did for the aileron hinges back in Step 2.

f) After all the glue is dry, adjust the wheel collar to sit snug against the bottom of the nylon tailwheel bearing. The purpose of the wheel collar is to keep any loads from the tailwheel from putting stress on the rudder.

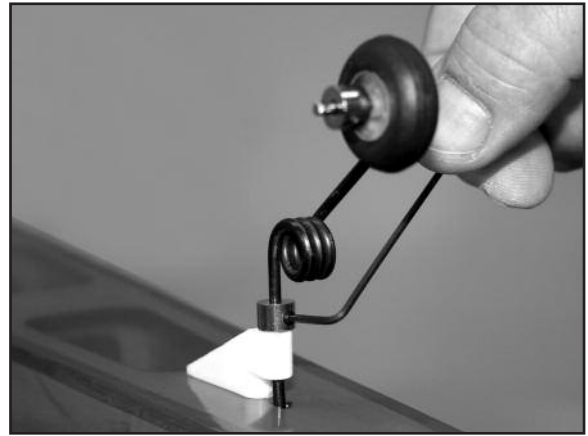

□ 18) Hinge the elevator to the stabilizer, using the same techniques you did for the ailerons back in Step 2 of this manual. Let the hinges dry before flexing them.

□ 19) Look closely and you will find three holes pre-drilled near the bottom of the rudder for mounting a nylon control horn. Install the control horn on the left side of the rudder, with the retaining plate on the right, using three M2 x 16mm Screws.



□ 20) There are three holes pre-drilled in the elevator for mounting a nylon control horn. Screw the control horn in position on the bottom of the elevator, with the retaining plate on the top, using three M2 x 16mm Screws.



ELEVATOR & RUDDER CONTROLS

For this section you will need:

- (1) Fuselage Assembly
- (2) 35.5" long Wire Pushrods with M2 Hex Nut

- (2) Metal RC Clevis
- (2) small pieces of Fuel Tubing
- (2) Pushrod Snap Keepers
- (1) Radio Receiver (not furnished)
- (2) Servos with Mounting Screws (not furnished)

□ 21) Install the rudder and elevator servos inside the fuselage in the built-in plywood radio mounting tray. Note that the rudder servo goes on the left side of the airplane, and the elevator servo goes on the right side. (The servo opening in the front right side of the tray is for the throttle servo in a glow installation.) Be sure to drill pilot holes through the plywood tray for the mounting servo mounting screws.



□ 22) Mount your receiver in a place of your choosing. If using a glow engine it is recommended that you wrap the receiver in foam rubber to protect it from vibrations.

□ 23) If you are using a receiver battery pack (some electric powered setups don't), mount your on/off switch in the fuselage side. Note that there are pre-cut holes in the fuselage sides, underneath the covering material, for either a standard size switch or a super switch with built-in charging plug. Cut away the covering over the hole that fits your switch and mount using the screw supplied with your switch.

□ 24) Assemble and install the rudder pushrod.
 a) First slide a small piece of Fuel Tubing onto the small end of the Metal R/C Clevis. Next screw the Hex Nut that is on the Pushrod Wire all the way up to the end of the threads. Then screw the metal clevis halfway onto the threads.

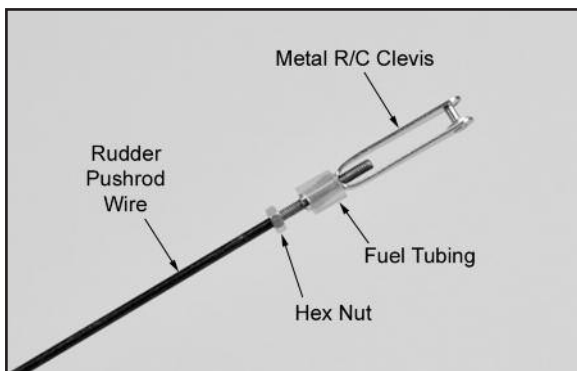

b) Locate the pre-cut pushrod exit hole for the rudder on the left side of the fuselage alongside the fin. Slide the plain end of the pushrod wire into the exit hole and inside the pushrod sleeve built into the fuselage. Slide it in until you can clip the clevis into the outer hole of the control horn. Lock the rudder in neutral position with tape, or with two small scrap balsa wood sticks or dowels held together with small rubber bands (as shown here).



c) Inside the fuselage, hold the pushrod wire over the rudder servo output arm and mark the wire where it crosses over the outer hole in the arm. Make sure the servo is in neutral position.

d) Unclip the clevis from the rudder control horn so that you can now pull as much of the wire pushrod forward into the radio compartment as possible, to make it easier to finish the servo end of the pushrod. Mark the servo end of the pushrod wire 1/4" past the mark you made in the last step. Then use a pliers to put a 90-degree bend in the wire.

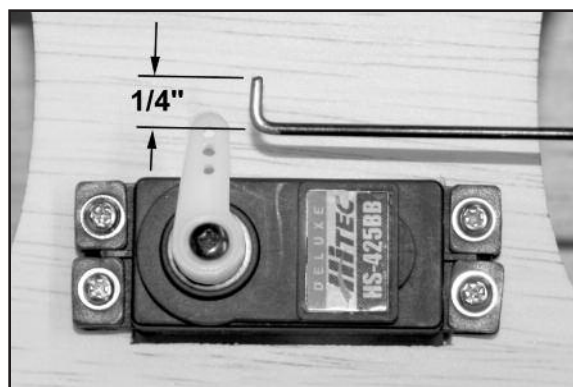

e) With the pushrod still disconnected from the rudder, remove the servo control arm from the servo. Install the servo arm and a nylon pushrod snap keeper on the end of the pushrod, as shown. Then re-install the servo arm on the servo.

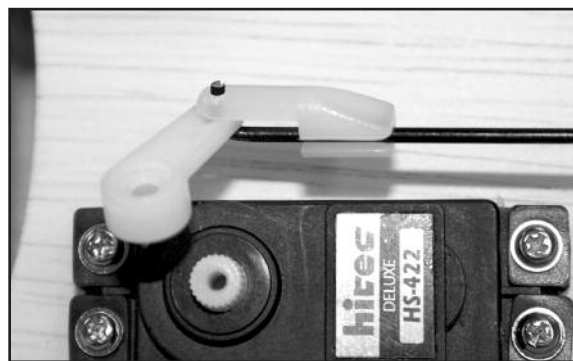

f) Make sure that the rudder servo is in neutral position and then adjust the metal clevis at the tail end as needed to get the rudder in perfect neutral position.

g) After the rudder is properly adjusted, insure that the metal clevis can't open up and come loose from the control horn by sliding the small piece of fuel tubing over the arms of the clevis. Also

tighten the M2 Hex Nut up against the back of the clevis

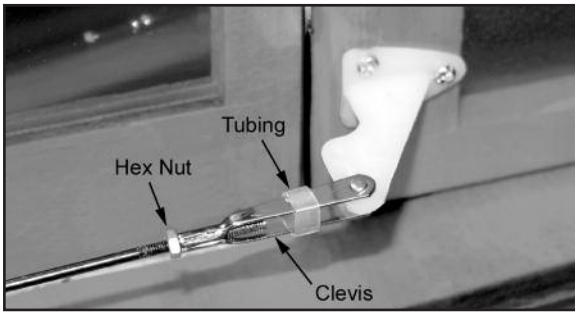

□ 25) Locate the pushrod exit hole for the elevator inside the rear of the fuselage and repeat step 24) in its entirety to install the elevator pushrod.

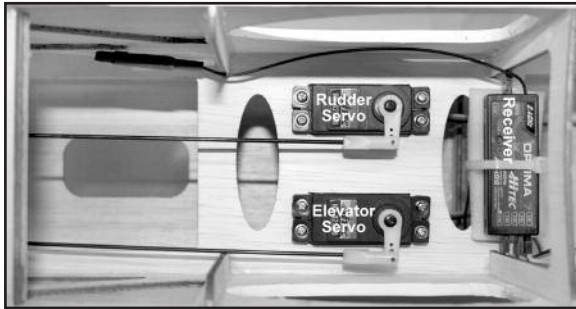

ELECTRIC MOTOR INSTALLATION

For this section you will need the Fuselage and:

- (1) Fiberglass Cowling
- (4) M3 x 9mm Screws
- (1) Balsa Triangle Stock
- (4) M4 x 16mm Socket-Head Bolts
- (4) M4 Split-Ring Lock Washers
- (4) M4 Blind Nuts
- (2) Hook-&-Loop (Velcro®) Straps
- (1) Electric Motor, ESC, Prop, Lipo Battery (not furnished)

□ 26) *NOTE: The mounting of the electric motor in the KADET SENIORITA assumes that your motor has a typical "X" or "cross" mounting plate on the back of the motor.*

Also note that the firewall portion of the laser-cut plywood motor mount is adjustable fore and aft to accommodate different length motors. In this step we will adjust the motor mount for your particular electric motor. For the KADET SENIORITA we need a total distance from the back of the plywood motor mount box to the motor's thrust washer to end up exactly 4.2". This distance allows the cowling to fit properly.

a) Assemble your motor according to the manufacturer's instructions. Then carefully measure the distance from the back of the mounting plate to the front of the thrust washer*.

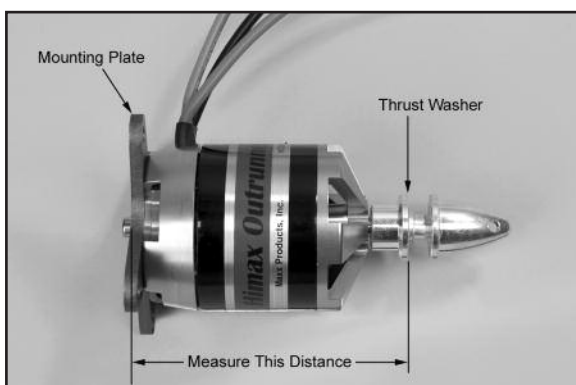

* The "thrust washer" is the part of the prop adaptor where the back of the propeller will be located.

b) Subtract the measurement taken in the previous step a) from 4.2". The result is the distance you need to locate the front of the firewall from the back of the plywood motor mount box. Carefully measure and mark the distance determined from the back edge of the motor mount box towards the front. Make the measurement along the top edge of the plywood side of the motor mount box, as shown here.

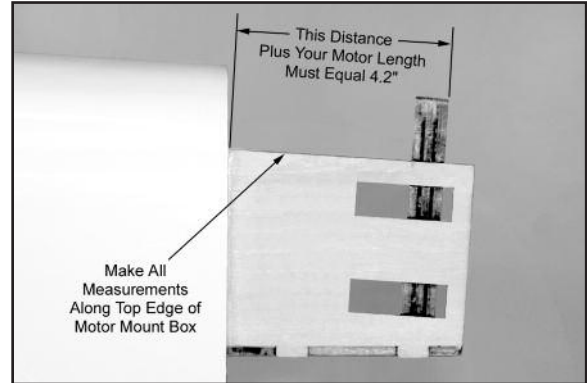

c) Carefully align the front face of the firewall with your marks. Make sure you end up with the firewall straight and square in the box. If it is not, recheck your marks and adjust as necessary.

d) Tack glue the firewall in place. Recheck once more to make sure that the front of the firewall is at the correct distance from the back of the motor mount box. That distance plus the length of your motor must equal 4.2". When satisfied it is correct, glue the firewall securely to the rest of the motor mount box.

□ 27 a) Note the short lines that are laser cut on the front of the firewall to indicate the thrust line for the motor. Use a sharp pencil to extend the lines at the 45 degree positions out to the edges of the firewall.

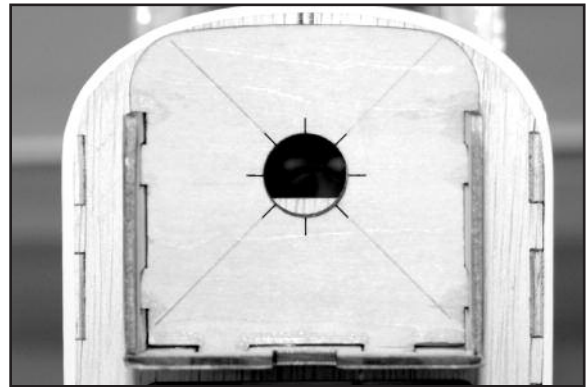

b) Center your X mount plate over the 45 degree lines. Once you are sure it is properly located, mark the mounting holes with a pencil. Set the X mount aside and drill out the mounting holes

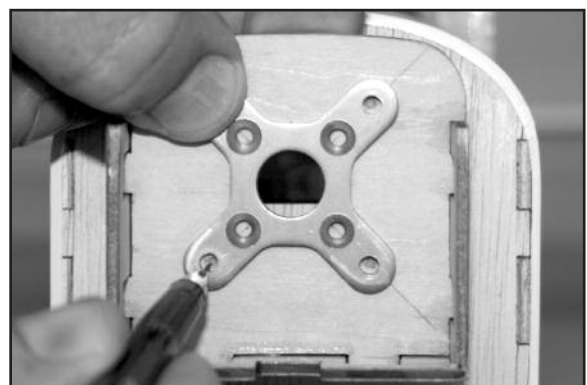

with a 7/32" dia. drill. Install four M4 Blind Nuts in the holes, on the back side of the firewall. Put a couple drops of glue on the flanges of the blind nuts to secure them to the plywood. Be careful not to get any of the glue in the threads.

□ 28) If you have not already re-attached the X mount plate to the back of your motor, do so now. Then use (4) M4 x 16mm Socket-Head Mounting Bolts and Lock Washers to bolt your motor in place on the plywood motor mount box.

□ 29) A long piece of balsa triangle stock provided to reinforce the motor mount. Measure, cut and glue pieces of triangle stock in all the corner joints inside the motor mount box.

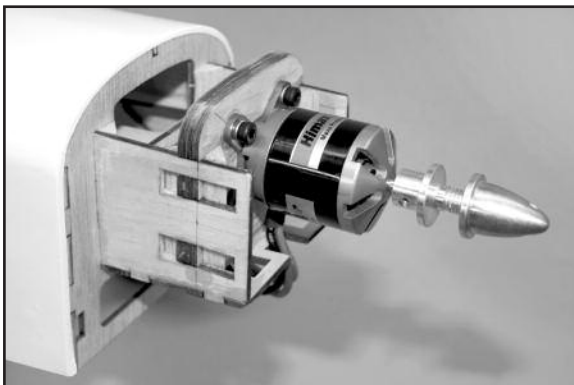
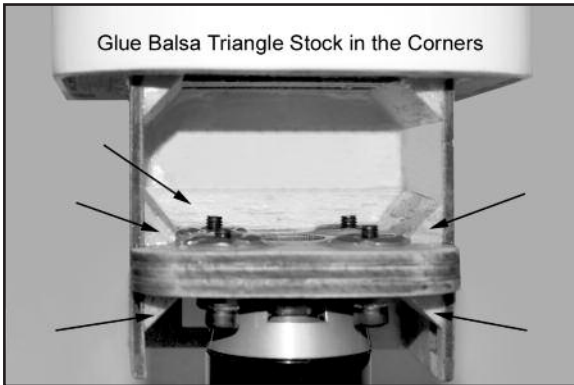

□ 30) Two hook-&-loop (Velcro®) straps are provided to hold your lipo battery pack in place inside the fuselage. Feed the straps through the slots in one side of the plywood battery tray, and then up through the other side. Put a couple small dabs of 5-minute epoxy to glue the straps to the plywood battery tray.

Optional: In addition to the two straps, it is a good idea to use hook-&-loop tape (not furnished) on the bottom of your battery pack and on the top surface of the plywood battery tray, to make sure the battery pack will not move around during aerobatics.

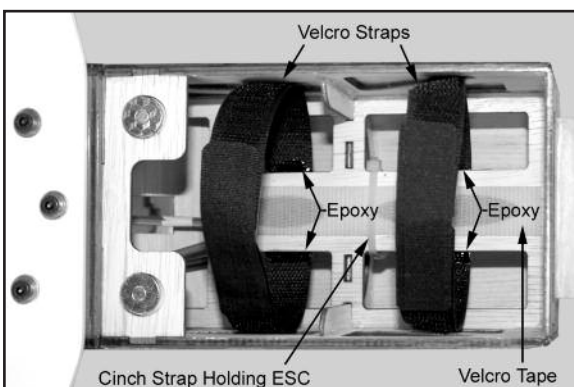

□ 31) Install your ESC
a) Solder appropriate battery connectors (not supplied) to the battery leads of your ESC.

b) Decide on a good location to mount the ESC. The most likely place in the KADET SENIORITA is in the top of the nose, above the plywood battery tray. Use a plastic cinch strap to secure it to the airplane structure.

c) Now route the ESC's servo wire back to the receiver and plug it in.

d) Connect the ESC's motor wires to the motor. Operate the motor and check the direction of rotation. Always do this without a propeller attached! If you need to reverse the rotation, refer to the instructions that came with the motor and ESC.

SAFETY ISSUE: We strongly recommend the use of an "arming switch" (not supplied) for your motor installation. With an arming switch you can install your battery pack in the airplane and hook up the wires without danger of the motor starting. The arming switch keeps the electricity away from the motor until you "arm" it when you are ready to takeoff. The most common arming switches are a simple external plug that puts a break in the positive battery lead to the motor, such as the Maxx Products Arming Switch shown below. There are also arming switches built into some of the advanced ESCs now on the market.

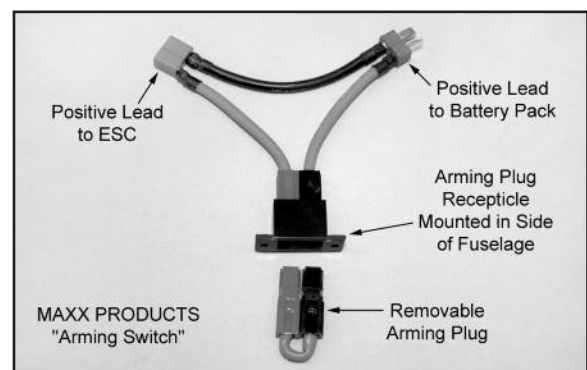

MOUNT THE COWLING

□ 32) Mount the cowling on the fuselage with the four M3 x 9mm Screws provided. Notice that the holes for the four cowl mounting screws are already pre-drilled in the cowling - two on each side.

a) First test fit the cowling on the fuselage. As you pass it over the motor, make sure all the wires are out of the way. Carefully adjust the exact position of the cowling. Make sure you have adequate clearance between the front of the cowl and the back of the propeller, and that the prop shaft is centered in the hole. Use low tack tape to hold the cowling in place for the next step.

b) Use a 5/64" or #45 bit to drill a pilot hole for the top left cowl mounting screw. Center the drill in the hole in the cowling and drill into the fuselage side. Install an M3 x 10mm screw in the pilot hole - do not over-tighten the screw.

c) Recheck the position of the cowling and make any adjustments needed to get it back in position.

d) Now drill another pilot hole for the upper screw on the other side of the cowling. Install the screw.

e) Repeat this process to install the two bottom cowl mounting screws. Remove all the tape.

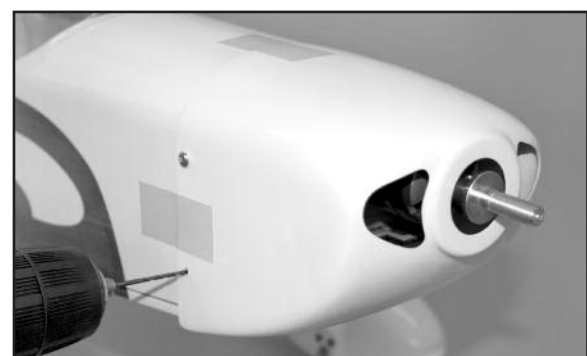

□ 33) COOLING IS IMPORTANT!

With a fully cowled motor, it is very important to make sure your power system is getting proper cooling. Air flowing into the front of the cowling must have a place to exit the cowl. In fact it's best to have more air exit area than inlet area to create a positive air flow through the cowling - an actual suction effect - drawing the heated air out of the cowling so that more cool air can come in. This positive air flow keeps your motor running cool.

The KADET SENIORITA cowling has openings in the front, on each side of the prop opening, to let air in. It also has a generous sized opening at the bottom rear edge of the cowling to let the air exit. Cooling air can also exit the fuselage through the open tail end of the airplane. In many cases these openings should provide adequate cooling for the KADET SENIORITA.

However if test flights indicate that your motor, ESC or battery need more cooling, you can make an additional air exit hole by removing the covering material over the oval shaped hole that is already cut in the bottom rear of the fuselage.

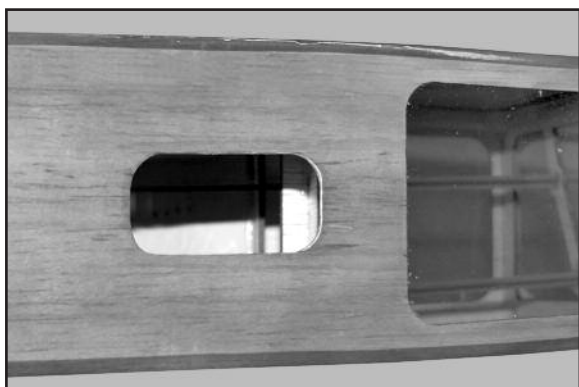

□ 34) Mount a suitable propeller (not furnished) on your motor. Be sure to balance the propeller before installation.

A plastic Spinner is included with this kit. Assembly of the spinner is simple, with two screws to attach the front cone to the spinner backplate. The hole in the spinner backplate will most likely need to be reamed or drilled out to fit over the prop shaft of your motor. Also check to make sure that the prop openings in spinner cone are large enough that the spinner cone does not come into contact with the prop blades.



Some of you may decide to leave the plastic spinner off to allow more cooling air to enter the cowling around the prop shaft. If so, be sure to use an "acorn" style prop nut for safety.



INSTALL SIDE WINDOWS

□ 35) From the kit contents, locate the bag containing the molded clear plastic side windows. The clear windows are molded to fit into the fuselage window frames from the inside. Note that each window has a flange all the way around the outside perimeter to provide a easy gluing surface. You may need to trim the flanges a little closer than the factory did, in order to fit them in place. A sharp scissors or snips works best for trimming the windows.

Glue the windows in place with 5-minute epoxy or RC-56 type glue. Do not use thin CA glue because it can cloud the plastic. Apply a thin bead of glue around the edge of the window and press the window in place from the inside of the fuselage. Don't use too much glue or it may ooze out onto the outside surface of the window. Use a few small pieces of low tack tape to hold the window in place until the glue dries.



CONGRATULATIONS!

Your KADET SENIORITA is completely assembled. However, it is NOT ready for flight! There are a few very critical pre-flight tasks we must perform before flying. These are extremely important and should be approached with patience and care.

BALANCE YOUR AIRPLANE

This may be the single most important step in preparing your airplane for flight. All airplanes, model or full-size, must be accurately balanced in order to fly successfully. An airplane that is not properly balanced will be unstable and will most likely crash.

NOT ALL KADETS WILL BALANCE THE SAME

It is impossible to produce a model airplane kit that will automatically have the correct balance point. Not everyone uses the same motor or radio gear - and all those items can vary in weight! Even propellers of the same size can vary as much as a 3/4 oz. between different brands. That's why every model must be balanced before flying. Don't feel that whatever the balance point your model came out at is "good enough". Check carefully and make whatever adjustments are required. Trying to fly an out of balance model is dangerous!

Preliminary: All the parts and components that will be in the airplane in flight must be installed in their correct positions. This includes all the radio gear, the propeller, battery pack, etc. Every piece of essential equipment must be installed, ready for flight.

RECOMMENDED BALANCE RANGE
3-1/2" to 3-7/8" Behind The Leading Edge Of The Wing
(3-1/2" = 28% of MAC; 3-7/8" = 31% of MAC)
Anywhere within this range is acceptable.

Using a ruler, measure back from the leading edge of the wing and mark the balance range on the bottom of the wing, next to the fuselage. Make the same marks on both sides of the fuselage.

Place your fingertips within the balance range on both sides of the airplane and carefully lift it off the table. No part of the model should be touching anything except your fingertips! If the KADET SENIORITA will sit on your fingertips in a level attitude, then it is properly balanced and ready to fly.

If the airplane sits on your fingertips in a nose down attitude, then it is nose heavy. You will have to add weight to the rear of the airplane to get it to balance. NOTE: Before adding additional weight to the model, try simply moving the battery pack to a further aft location. The battery pack is relatively heavy and therefore makes a good balancing tool. If you can't get your model balanced simply by re-locating the battery pack, then you will have to purchase lead weights from your hobby dealer and glue them into the tail end of the fuselage.

If the airplane sits on your fingertips with the tail down, it is tail heavy. DO NOT ATTEMPT TO FLY IT! A tail heavy model is very dangerous and will most likely crash!! Weight will have to be added to the nose of the model to bring it into balance. The weights can be glued to the front of the firewall; or inside the cowling. There are also "spinner weights" available for tail heavy models. Wherever you put the balancing weight, make sure it cannot come loose in flight! Because the KADET SENIORITA has so much wing area, adding balancing weight will have little effect on its flying ability.

CONTROL SURFACE TRAVEL

Double check the alignment and movement of all the controls one more time! Adjust all of your pushrod linkages so that the control surfaces are in their neutral position when the transmitter sticks and trim levers are centered. Make sure the control surfaces move in the proper direction when you move the sticks. You'd be amazed to know how many models have been destroyed on take-off with one of the controls reversed. Don't let it happen to you! In fact, it's a good idea to get into the habit of checking for proper control response every time you get ready to fly.

The maximum distance that a control surface moves when you move the transmitter stick to full deflection is called the "control throw" or "control travel". This determines how responsive the airplane will be to your control inputs.

We suggest the following control travel for beginning R/C pilots.

RECOMMENDED CONTROL SURFACE TRAVEL

AILERONS: 3/4" UP, 3/4" DOWN

ELEVATOR: 5/8" UP, 5/8" DOWN

RUDDER: 1" LEFT, 1" RIGHT

Adjust your pushrod linkages and/or transmitter EPA (End Point Adjustment) settings as necessary to provide the recommended amount of control surface travel. NOTE: The rudder measurement is taken from the bottom of the rudder, at its widest point.



FLYING

The KADET SENIORITA is designed to give you the best possible chance to succeed in learning to fly R/C. However, learning to fly model airplanes is not a skill you can learn overnight. It's very similar to learning to fly a real airplane in that you should go through a learning phase with an instructor before you try to pilot the airplane yourself. A lot of things can go wrong with these machines, and if you are not prepared to deal with them instantly, you will lose your brand new airplane in a crash. To practically eliminate any chance that your first flight will end in disaster, we strongly recommend that you seek the assistance of a competent R/C pilot to help you with your first flights.



An instructor serves two purposes. First, he will take your model up for its first test flight to make sure it is performing properly before you try to fly it. When a brand new R/C model takes off for the first time, there is no way of knowing which way it is going to go. Some models will try to climb steeply, while others may want to go down. Some will try to turn left, others right. Some models will be doing both at the same time! It doesn't mean that there is anything wrong with the model, but these minor differences must be "trimmed out" in order for the model to fly "hands-off" straight and level. An experienced pilot can instantly correct for out of trim conditions before the model crashes into the ground. An inexperienced beginner has almost no chance of saving an out of trim model!

The second reason for an instructor is to have someone there who can correct any mistakes you make when you take over the controls for the first time. Let the instructor get the model airborne and flying straight and level at a safe attitude ("several mistakes high" as the old saying goes) before he turns the transmitter over to you. You will quickly find out that it is very easy to over control an R/C model and to get disoriented - EVERYONE DOES IT AT FIRST! If you get out of control on your first flight, quickly hand the transmitter back to your instructor so he can rescue the airplane. He will get it leveled off and then let you try it again. Without an instructor, you would not get a second chance!



It's not that learning to fly R/C is difficult, it's just a lot different than anything you have ever done before. Anyone can learn to fly the KADET SENIORITA if they are willing to listen and learn! Remember the first time you tried to ride a bicycle? It seemed completely awkward the first time, but once you learned how, it quickly became very easy. Learning to fly R/C model airplanes also comes quickly to many people. Fly your KADET SENIORITA as often as possible. After you get a few flights under your belt with an instructor at your side, you will begin to feel more comfortable at the controls. Soon you will be flying "solo" with little thought of the moves required.

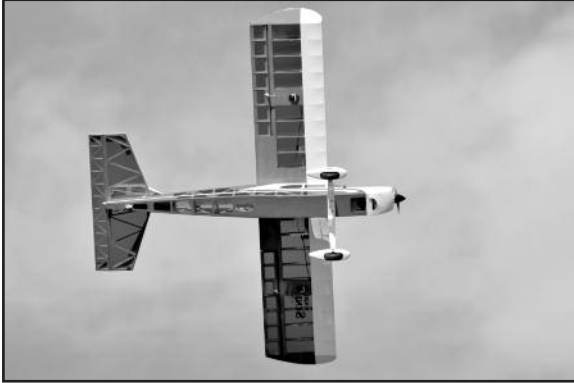

Because of its light wing loading, the KADET SENIORITA is best flown in light or no wind conditions. For initial test flights, we strongly recommend that you choose a calm day with little wind. That way the airplane can be much more easily and accurately trimmed. The goal is to trim the airplane for "hands off" level flight at cruising speed.



On the initial test flight, you may find that you need a little "down" trim in the elevator to get your KADET SENIORITA to fly level. This is not uncommon and is perfectly normal for a flat-bottom airfoil airplane. Flat bottom airfoils are very speed sensitive - i.e. the faster the airplane flies, the more it wants to climb. Airplanes like the KADET SENIORITA, with a very light wing loading, also have a very wide speed range. The speed at which you fly the KADET will determine the elevator trim setting you need to achieve hands-off level flight. You will also find that everytime you change your throttle setting (and thus your airspeed) you need to change your elevator trim. So don't be alarmed if you need a little down elevator trim to fly hands-off level at your cruising speed. It's not uncommon for this type of airplane. Most KADET SENIORITAS will fly level at "normal" cruising speed with the elevator drooped down about 1/8" or so.

The KADET SENIORITA is capable of mild aerobatics, such as loops, rolls, Immelman turns, stall turns, Cuban 8s, etc. A competent pilot can fly it inverted. However, the design is really intended for training beginning pilots and leisurely slow flying.

Good luck and safe flying!

JOIN THE AMA

The governing body for radio-control model airplanes in the United States is the **ACADEMY OF MODEL AERONAUTICS**, commonly called the **AMA**. The **AMA SAFETY CODE** provides guidelines for the safe operation of R/C model airplanes. While AMA membership is not necessarily mandatory, it is required by most R/C flying clubs in the U.S. and provides you with important liability insurance in case your R/C model should ever cause serious property damage or personal injury to someone else. For more information, contact:

ACADEMY OF MODEL AERONAUTICS
5161 East Memorial Drive
Muncie, IN 47302
Telephone: (765) 287-1256

AMA WEB SITE: modelaircraft.org

CUSTOMER SERVICE

SIG MFG. CO., INC. is committed to your success in both assembling and flying the KADET SENIOR SPORT ARF. Should you encounter any problem building this kit or discover any missing or damaged parts, please feel free to contact us by mail or telephone.

SIG MFG. CO., INC.
P.O. Box 520
401 South Front Street
Montezuma, IA 50171-0520 USA

PHONE: 1-641-623-5154
FAX: 1-641-623-3922

SIG WEB SITE: www.sigmfg.com
SIG E-MAIL: mail@sigmfg.com

WARNING! THIS IS NOT A TOY!

Flying machines of any form, either model-size or full-size, are not toys! Because of the speeds that airplanes must achieve in order to fly, they are capable of causing serious bodily harm and property damage if they crash. **IT IS YOUR RESPONSIBILITY AND YOURS ALONE** to assemble this model airplane correctly according to the plans and instructions, to ground test the finished model before each flight to make sure it is completely airworthy, and to always fly your model in a safe location and in a safe manner. The first test flights should only be made by an experienced R/C flyer, familiar with R/C aircraft.

LIMIT OF LIABILITY

The craftsmanship, attention to detail and actions of the builder/flyer of this model airplane kit will ultimately determine the airworthiness, flight performance, and safety of the finished model. SIG MFG. CO.'s obligation shall be to replace those parts of the kit proven to be defective or missing. The user shall determine the suitability of the product for his or her intended use and shall assume all risk and liability in connection therewith.

SIG MFG CO., INC. 401 S. Front St. Montezuma, Iowa 50171 U.S.A.