

SKADET SENIORITA EP



ALMOST READY TO FLY

ASSEMBLY MANUAL



KIT NO. SIGRC60ARF



SIG MANUFACTURING COMPANY, INC.

**KADET
SENIORITA EP**
ALMOST READY TO FLY



KADET SENIORITA EP ARF ASSEMBLY MANUAL

INTRODUCTION:

Congratulations on your purchase of the new SIG KADET SENIORITA EP ARF kit! The Kadet Seniorita was originally designed by Claude McCullough, following the same guidelines as it's larger brother, the Kadet Senior, but in a more manageable size. Claude put a great deal of thought into the Senior design and came up with an R/C training aircraft, that was just about perfect. Since it's introduction in 1987, the Kadet Seniorita became one of the favorite trainers for thousands, with its low wing loading and slow flight characteristics. As proof, it's safe to say that in the following years, the Kadet Senior and Seniorita have been used to train thousands of modelers to fly. In addition, these designs have been used for many other applications, as well as being "kit bashed" into any number of different configurations. The Kadet Seniorita kit is still in production and remains a true model aviation classic.

Over the years we have received many requests to equip the Kadet Senior with ailerons, something we did with the ARF version. Now, we have also added ailerons to the Kadet Seniorita EP ARF kit, making it all that much more usable in the training role it was designed for. In addition, we have designed the Kadet Seniorita EP ARF for electric power. With the new brushless motors and lithium polymer (LiPo) batteries, you can now enjoy 15+ minute flights, during which you can do aerobatic maneuvers that used to only capable with typical glow engines. Electric power allows you to climb high and shut the motor off to soar with the birds, turn it back on again to do touch and goes before landing and taxiing back at the end of the flight. The Kadet Seniorita EP ARF raises the benchmark for all ARF electric powered trainer/sport airplanes. Large and slow enough to learn on at reduced throttle settings and yet fully capable of sport aerobatics, when called upon to do so.

The Kadet Seniorita EP ARF has been expertly covered with transparent covering to show off its beautiful classic structure. The wing has been designed to be a 2-piece assembly, allowing easy transportation to and from the field and simplified storage. The landing gear system is very forgiving, making even the worst landings look just a bit better.

We urge you to read this assembly manual completely before assembly. Familiarize yourself with the parts and their assembly sequences. The successful assembly and flying of this airplane is

your responsibility. If you deviate from these instructions, you may wind up with problems later on. The Kadet Seniorita EP ARF is certainly a suitable R/C model for beginning modelers. *However, it is important to understand that if this is your first R/C model, you will need to find and use a qualified R/C flight instructor to test fly the airplane and teach you how to fly it. If this is your first radio control mode, we urge you to NOT attempt to fly it without a qualified instructor.*

AIRCRAFT SPECIFICATIONS:

Wingspan:	63 in.	1600 mm
Wing Area:	750 sq. in.	48.4 dm ²
Length:	52 in.	1320 mm
Flying Weight:	74 oz.	2097 g
Wing Loading:	14.2 oz./sq. ft.	43.3 g/dm ²
Order Number:	SIGRC60ARF	

RECOMMENDED EQUIPMENT:

Motor:	400 Watt Brushless Outrunner	
Battery:	3-Cell 3300 mAh Lithium Polymer	
ESC:	45A (minimum)	
Radio:	4 Channel with 4 Standard Servos	

RADIO EQUIPMENT:

The Kadet Seniorita EP ARF requires a standard 4-channel radio system with 4 standard servos. In this assembly manual, we used and show the Hitec LASER 4 radio system with HS-322HD standard servos. In addition, you will need two 12" servo extension leads and a 12" Y-harness to connect the aileron servos to the receiver.

ELECTRIC MOTOR SELECTION:

The motor choices for your Kadet Seniorita EP ARF are many, but in general, you will need a motor with about a 400-watt output. For this assembly manual, we used and show the HIMAX HC3522-0990 brushless outrunner motor and a Phoenix 45 amp electronic speed control (ESC). We, also, use a 3-cell, 3300 mAh Lithium Polymer battery and a APC 10 x 7E propeller for flights in excess of 12 minutes. With this motor the Kadet Seniorita EP ARF will easily cruise at 1/2 throttle, yet fly most sport aerobatic maneuvers including loops, rolls, touch and goes, and inverted flight with less than full power. It will also fly this motor and prop combination with a 10 cell, 3300 mAh Nickel Metal Hydride battery pack. We strongly suggest that you choose and have available your own motor and ESC during the assembly of this model.

COVERING MATERIAL:

Your Kadet Seniorita EP ARF has been professionally covered with premium covering. If you live in a drier climate, you may notice that some wrinkles might develop after removing the covered parts from their plastic bags. If that is the case, there is no need to be alarmed. The covering is not defective. This is normal and has nothing to do with the covering material or how it was applied.

MODELER'S TIP: One of the most common problems associated with shrinking any covering film is controlling the heat around the seams. Heat applied too close or directly onto seams re-heats the covering adhesive and the seams will often "crawl". This is easy to control. Just tear a few paper towels into strips and soak them in cool tap water. Lay the wet strips over the covering and use a heat gun or iron as you normally would. The wet strips keep the seam cool while the covering immediately next to it shrinks. This tip work great with any iron-on covering.

Any wrinkles that appear in the covering are easy to remove by using a hobby-type of heat iron. We suggest covering the iron's shoe with a thin cotton cloth, such as an old T-shirt to prevent scratching the film. To shrink this covering, set the temperature of your covering iron to 220°F - 250°F (104°C - 121°C). Start by using the heated iron to go over all the seams and color joints, making sure they are firmly sealed and well adhered. Then, use the heated iron to lightly shrink the material - do not press on it. Once the covering is tight, lightly iron the covering back down to the wood. You can use a hobby type heat gun to re-shrink the covering, but you must be very careful to avoid heating the seams. Your Kadet Seniorita EP ARF has been covered with a transparent red and a black covering material.

REQUIRED TOOLS:



For proper assembly, we suggest you have the following tools and materials available.

- A selection of glues, such as:
 - SIG Thin, Medium, and Thick CA
 - SIG Fine Tip Applicator Tips for CA
 - SIG CA Debonder
 - SIG Kwik-Set 5-Minute Epoxy
 - SIG Epoxy (slow cure)
- Thread locking compound, such as Loctite® Non-Permanent Blue
- Screwdriver Assortment
- Needle Nose & Flat Nose Pliers
- Diagonal Wire Cutters
- Small Allen Wrench Assortment
- Electric Drill and Assorted Small Diameter Bits - 1/32", 1/16" dia. typical
- Pen Vise for Small Drill Bits
- Hobby Knife with Sharp #11 Blades
- Soldering Iron & Flux (for battery and ESC connectors)
- Paper Towels
- Rubbing Alcohol for Clean Up
- Scissors
- Covering Iron and Trim Seal Tool
- Masking Tape
- Sharp Pencil and a Fine-Tip Felt Marker Pen

KIT CONTENTS:

The following is a complete list of every part included with your Kadet Seniorita ARF kit. Use the check-off blocks (☐) to inventory your kit **before** beginning assembly. Note that the CA type hinges for the ailerons, rudder, and elevators are in place in each of these parts but are not yet glued in place. Also, note that the bolts and nuts required to mount your motor are not included in this kit and must be purchased separately.

Note that we suggest keeping the hardware parts for this kit in their bags, as received. This is of help to you when looking for the various parts required for the following steps. We, also, suggest removing the covered parts from their bags, allowing them to adjust to the ambient humidity present in your particular geographical location.

- Bag #1 ☐ Right Wing - Covered and trimmed with a covering
 Aileron hinged with three (3) CA hinges, not glued
 Aileron servo hatch/mount installed with 4 ea. T2 x 6 PWA Tab on front of root rib for wing hold down
 Trailing edge drilled for hold down bolt
 Receptacle for wing joiner blade built into main spar
 3 mm dia. locator pin in root rib at rear spar location
- Bag #2 ☐ Left Wing - Covered and trimmed with a covering
 Aileron hinged with three (3) CA hinges, not glued
 Aileron servo hatch/mount installed with 4 ea. T2 x 6 PWA Tab on front of root rib for wing hold down
 Trailing edge drilled for hold down bolt
 Receptacle for wing joiner blade built into main spar
- Bag #3 ☐ Vertical Fin and Rudder Assembly - Covered and trimmed with a covering
 Rudder hinged with three (3) CA hinges - not glued.
- Bag #4 ☐ Horizontal Stabilizer & Elevator Assembly - Covered and trimmed with a covering
 Stabilizer and elevator hinged with five (5) CA hinges - not glued
- Bag #5 ☐ Fuselage - Covered & Trimmed with a covering
 Side windows installed.
 Removable bottom hatch taped in place.
 Battery compartment floor and baffle installed
 Servo tray in place
 Four (4) M3 blind nuts in place for nose gear bearing.
 Two (2) 10-32 blind nuts installed for wing hold down.
- Bag #6 ☐ Formed plastic cowl, trimmed, with four (4) pre-drilled mounting holes
 ☐ Sub bag 4 each T2.6 x 8 mm PWA mounting screws
- Bag #7 ☐ Formed and trimmed windshield with 6 holes drilled for screws
 ☐ Sub bag 6 each T2 x 8 PWA screws
- Bag #8 ☐ Landing Gear
 2 each Main Landing Gear Wire forms - 4 mm wire
 1 each Nose Gear Wire form - 4 mm wire
 ☐ Sub bag A
 4 each 4.1 mm ID wheel collars with set screws
 3 each 4 mm ID plastic spacers
 3 each Landing gear & battery hatch retainer straps
 5 each T2.6 x 12 mm PWA mounting screws
 ☐ Sub bag B
 1 each 4.1 ID steering arm with set screw
 4 each M3 x 15 mm Phillips head bolts
 1 each Nylon nose gear bearing
 1 each Hex wrench for nose gear steering arm - 1.5 mm
- Bag #9 ☐ Pushrod Bag
 1 each 10 mm x 400 mm heat shrink tube
 1 set 25 mm x 360 mm Velcro® fastener strip
 1 each 8 mm dia. x 600 mm elevator pushrod - hardwood dowel, drilled and grooved each end
 1 each 8 mm dia. x 432 mm rudder pushrod - hardwood dowel, drilled and grooved each end
 1 each 300 mm tie wrap
 1 each 5 mm O.D. x 250 mm female nose gear steering tube

1 each 3 mm O.D. x 300 mm male nose gear steering pushrod

❑ Sub bag A

1 each Pushrod connector with set screw and keeper

2 each M2 x 24 mm threaded studs

1 each 2 mm R/C link

8 each M2 nuts

❑ Sub bag B

2 each 2.6 mm dia. x 55 mm aileron pushrods - threaded M2 each end and 2 mm R/C link on each end

2 each 2.6 mm dia. x 100 mm rods threaded M2 on one end with a 2 mm R/C link installed and a 90° bend at the other - for rudder & elevator pushrods

1 each 2.6 mm dia x 110 mm rod threaded M2 on one end with a 2 mm R/C link installed and a 90° on the other - for elevator pushrod

1 each 2.6 mm dia. x 200 mm rod threaded M2 on one end with a 2 mm R/C link installed and a 90° bend on the other - for rudder pushrod

Bag #10❑ Miscellaneous Hardware

❑ Sub Bag A

4 each Nylon control horns

2 each 10-32 x 1" nylon wing hold-down bolts

4 each T2 x 4 mm PWA screws - elevator and rudder control horns

4 each T2 x 12 mm PWA screws - aileron control horns

Bag #11❑ 3 each 70 mm (2-3/4") dia. wheels

Bag #12❑ 1 each 2" spinner, black plastic with retaining screws

Bag #13❑ Motor Spacer Bag

6 each 3 mm thick plywood motor spacers

4 each T3 x 20 mm PWA screws

Bag #14❑ 4 each Servo mount blocks, hardwood - 20 mm x 20 mm x 10 mm

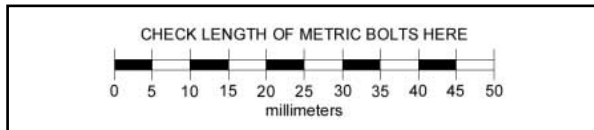

WING ASSEMBLY:

The wing has been designed and made to be a 2-piece system, joined by the main aluminum blade joiner at the box spar location, with a steel locating pin at the rear. This joiner system has proven to be very tough and easy to use. An obvious benefit, especially with a model of this size, is the fact that the wing panels can be easily transported or stored, requiring a minimum of space. You may want to consider using a little 5-minute epoxy to permanently install the aluminum blade joiner and the rear steel locating pin into one of the panels. Doing this prevents accidentally losing these parts. Also, if space is not an issue, the two wing panels can be permanently epoxied together - your call.

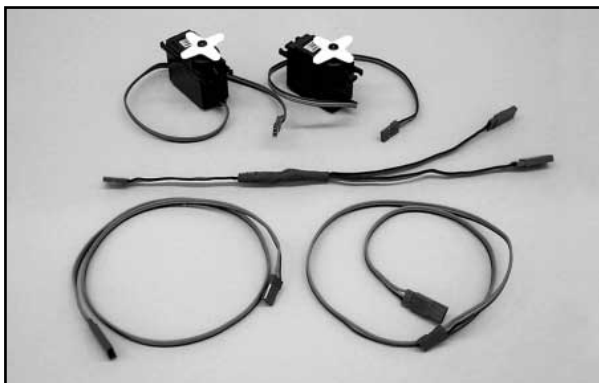

Note that as received, the wing panels have the ailerons in place, but not yet permanently hinged. Hinging the ailerons will be done in the first few steps. To protect the covered parts of your model from unnecessary damage, we suggest covering your work surface with protective foam or an old blanket. For the following steps, you will need two standard servos, two 12" servo extensions, and a dual servo Y-harness for your particular radio system.

❑ 1) Remove the aileron from one of the wing panels and pull out the CA hinges from their slots. Note that the supplied hinges have a die-cut center slot that can be used to accurately place and center the hinge equally into both the wing panel and aileron. To do this, use scrap card stock and a pair of scissors to cut some "wedges". These should be wide enough at one end so as to not pass through the hinge slot cutout.

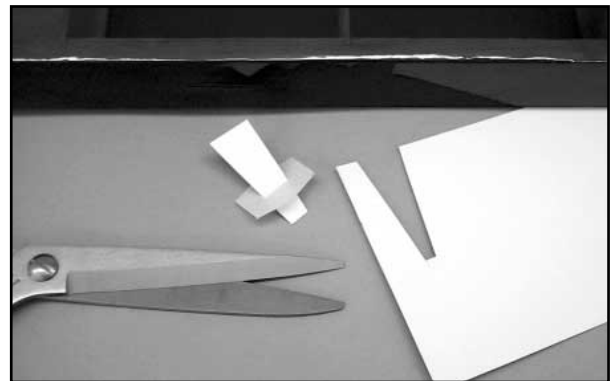

❑ 2) Press the three hinges into the slots in the wing panel up to the hinge slot cutout. Place a card wedge into each hinge and then, press the aileron in place onto each exposed hinge half, up to the card wedges. Slide the aileron left or right to center it within the wing panel aileron bay. The hinges are now in proper position for permanent mounting.

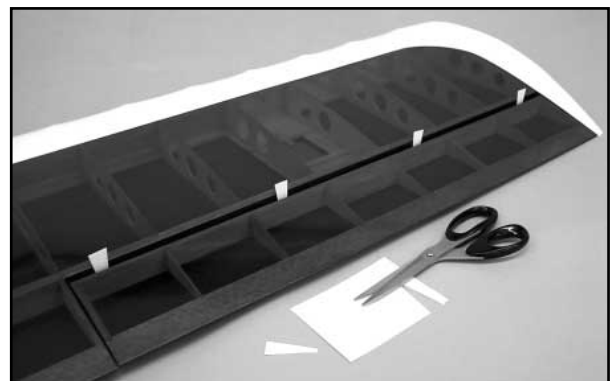

❑ 3) Flex the aileron downward, exposing the hinges between the wing and the aileron. Hold the aileron in this position with a

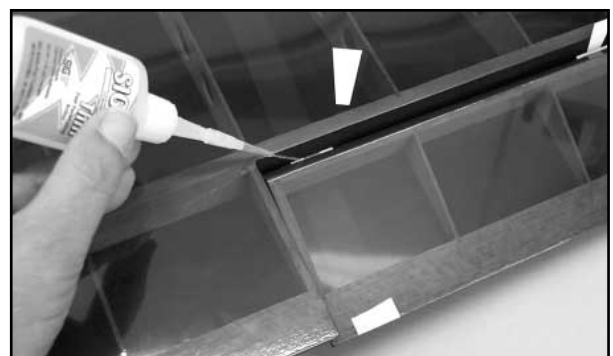

piece of masking tape. Remove the card wedge from one of the hinges and carefully apply four (4) drops of thin CA glue to each side of the exposed hinge - two (2) drops on each side of the die-cut slot. Note that using a fine applicator tip on the CA bottle is of great help in better controlling the flow of glue. Remove the card wedge from next hinge and once again apply four (4) small drops of CA glue to each side of the exposed hinge. Remove the last card wedge and apply CA glue to the hinge.

❑ 4) Remove the tape holding the flexed aileron to the wing panel and flex the aileron in the opposite direction, again, using masking tape to hold the aileron in this position. Turn the wing panel over and apply four drops of CA glue to each exposed edge of each hinge, exactly as before. Remove the tape holding the aileron and return the aileron to its centered position. Because it takes a little time for the CA glue to fully wick through the surface of the hinge and into the surrounding wood, allow at least 10 minutes before flexing the aileron. Any excess glue drops or smears can be quickly cleaned up using SIG CA Debonder.

❑ 5) After sufficient time has passed, briskly flex the aileron up and down on the wing panel to create free and easy movement. We, also suggest pulling on the aileron at each hinge location, making sure all three hinges are firmly in place. Hinge the opposite aileron using this same procedure.

❑ 6) Turn the wing panels upside down on your work surface. Note that the aileron cover/mount is in place with screws. Remove the screws and then, remove the cover. Mark these covers, noting them as "left" and "right". Also, note that a short piece of wood with a string tied to it is visible through the cover opening. This is one end of the string that will be used to pull the aileron servo lead through the wing. The opposite end of this string can be found, tied to another scrap piece of wood at the round opening in the bottom center section of the wing panels.

❑ 7) Prepare the two aileron servos for mounting by first installing the rubber grommets and eyelets that came with your radio system into the mounting lugs of each servo. Place long servo arms onto the servo output shafts, at 90° to the servo bodies. Position the servo on the back side of the hatch so that the servo is centered on the hatch and the servo arm is centered within the servo arm slot. With the servo in this position, use a sharp pencil to mark the position of the mounting lugs. Repeat this step for the opposite aileron cover/hatch.

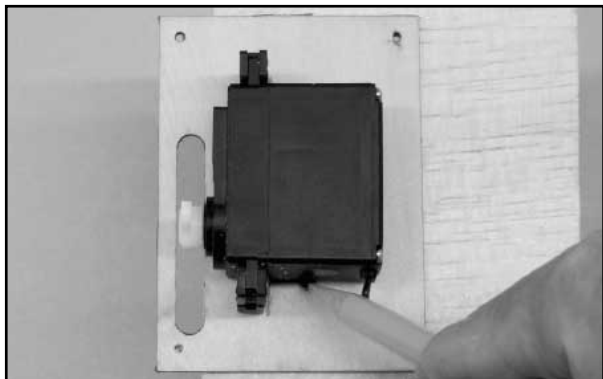

❑ 8) Use epoxy or thick CA to glue two 20 mm x 20 mm x 10 mm hardwood servo mounting blocks to each aileron cover as shown. When the glue has set, the servos can be mounted to the hatch/mounts using the servo mounting screws that came with your radio system. Use a 1/16" dia. bit to drill pilot holes for the servo mounting screws.

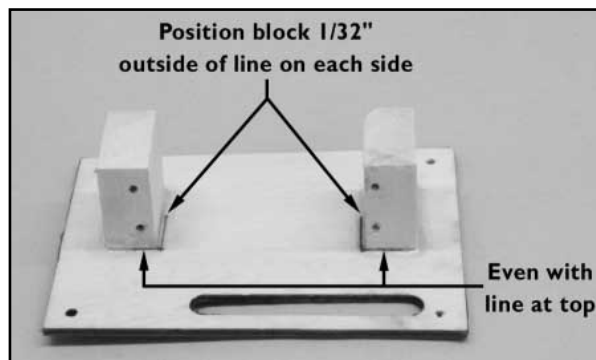

❑ 9) In this step, you will center both aileron servos and check their movement for the correct direction. Connect the two aileron servos to the Y-harness. Plug the Y-harness into the aileron receptacle in the receiver. Turn your transmitter on and plug your airborne battery pack into the battery receptacle in your receiver. Be sure the aileron trim lever on the transmitter is in neutral. If necessary, remove the servo arm retaining screws and reposition the servo arms to as close to 90° to the servo as possible.

Move the transmitter aileron stick left and right to determine if the servos are moving in the correct directions to produce the correct aileron movement. The right aileron servo should "push" back toward the aileron for right aileron while the left aileron servo arm "pulls" forward. If this is how your servos are moving, they are moving correctly. If they are moving in the wrong direction, use the servo-reversing feature in your transmitter to reverse the movement. Once again, check the position of the output arms to make sure they are pointing straight down at 90° to the servo body. Once satisfied, replace the servo arm retaining screws. Disconnect the servos from the receiver and Y-harness and turn off the radio system.

The right and left aileron servos are now installed onto the right and left aileron servo mount/hatches, using the screws supplied with your radio system.

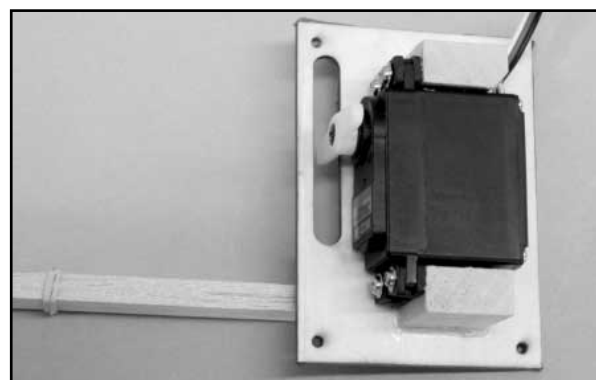

❑ 10) Install a 12" servo extension lead onto each servo lead. We suggest using heat shrink tubing or tape to secure these two lead connections. In the aileron hatch opening, in the wing panel, break the scrap piece of wood loose that has the servo lead extension string attached to it. Cut the scrap piece of wood away, leaving just the end of the string. Securely tie the string end to the end of the servo extension connector. At the wing panel center section area, locate the scrap piece of wood that is holding the opposite end of the retrieval string. Break the scrap piece of wood away from the wing. This end of the string is now used to gently pull the servo extension lead through the wing panel and out of the round hole at the center section.

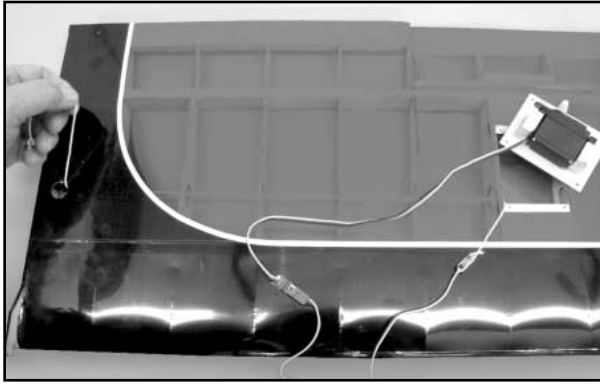

When the extension connector is pulled through and out of the hole, pull the rest of the lead assembly out of the hole while fitting the aileron hatch in place into the opening at the outer end of the panel.

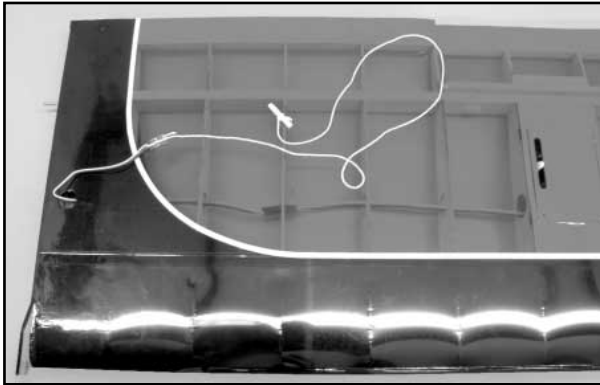

Repeat this process to route the servo extension lead and to seat the aileron servo mount/hatch in the opposite wing panel. Temporarily tape the loose aileron extension leads to their respective wing panels. The two aileron servo hatch/mounts can now be secured to each wing panel with the screws removed earlier.

□ 11) As shown, the aileron control horns are positioned 3" out from the inboard end of the aileron to the vertical arm on the control horn. Mark the two mounting hole locations for the control horn screws onto the surface of the aileron. Use a 1/16" dia. bit to drill two holes at the marks just made, approximately 1/2" deep. Mount the control horn to the aileron using two T2 x 12 mm PWA screws. Repeat this process on the opposite aileron.

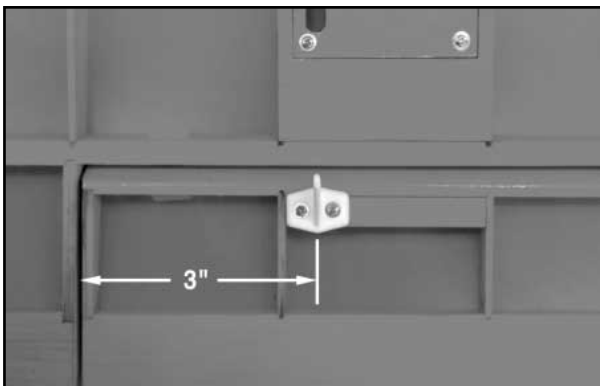

□ 12) From the kit contents, locate the two 2.6 mm dia. x 55 mm aileron pushrods with R/C links and lock nuts on each end. Note that, as shown, we use short lengths of fuel tubing over each R/C

link to hold them firmly in place and suggest you do the same thing.

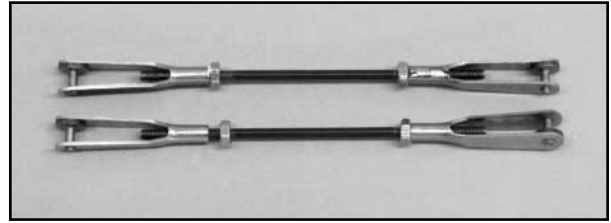

Clamp the trailing edge of both ailerons in the neutral position to the wing panels as shown. Again, connect the two servo leads to the Y-harness and plug the harness into the aileron receptacle in your receiver. Turn your transmitter on and then, plug the airborne battery pack into the battery receptacle in your receiver. Make sure the transmitter aileron trim lever is in neutral.

□ 13) Attach the R/C link into the outer hole of the servo output arm. Now, adjust the length of the pushrod until the opposite R/C link fits easily into the outermost hole in the control horn arm without pushing or pulling the aileron in either direction. Use the same procedure to attach the pushrod assembly to the opposite wing panel servo and control horn. Firmly tighten the lock nuts against the R/C links to lock them in place.

Remove the clamps holding the ailerons in neutral and use the transmitter to check the movement of the ailerons. Double check the aileron movement to make sure that right aileron stick movement moves the right aileron up. Once satisfied, disconnect the battery pack and Y-harness from the receiver and turn off the transmitter.

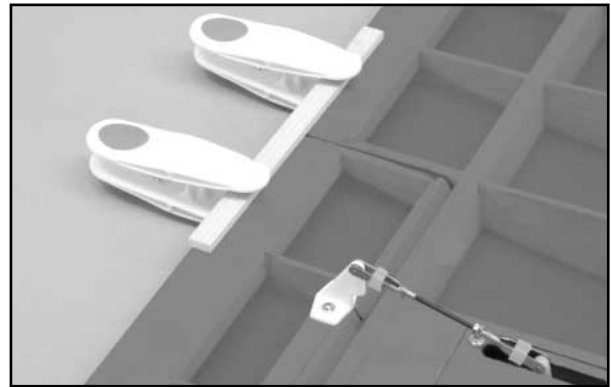

With the exception of applying the decals, the wings are now complete and ready to use in final assembly. Set the wing panels aside for now.

FUSELAGE ASSEMBLY:

□ 1) From the kit contents locate the 5 mm OD x 250 mm (3/16" x 9-7/8") white plastic tube. This is the outer housing tube for the nose wheel steering pushrod. Lightly sand the outer surface of the tube.

From the inside of the fuselage, in the radio compartment on the left side, insert one end of the steering housing tube through the hole in the small plywood tab, located just beneath side window. Slide the tube forward into the slot in the battery tray. Leave about 1/8" of tubing exposed behind the plywood tab. Use medium or thick CA glue to glue the tubing in place to the tab.



□ 2) Prepare the rudder and elevator servos for mounting by first inserting the rubber grommets and brass eyelets provided with your radio system. Place both servos into the servo tray in the fuselage and use a sharp pencil to mark the mounting screw locations for both servos onto the servo tray. Remove the servos and use a 1/16" drill bit to drill pilot holes for the servo mounting screws at the marks just made. Reinstall the servos into the servo tray with their output shafts oriented to the rear as shown. Secure the servos in place to the tray using the screws provided with your radio system.



□ 3) It is now time to prepare your electronic speed control (ESC) for mounting. Solder any required battery connectors to both the battery pack and ESC, being careful to maintain correct polarity. With the ESC properly prepared, it can now be installed into the fuselage. As shown, we mounted our ESC in the battery compartment, against the right fuselage side, using a 1-1/2 piece of the provided Velcro® tape. Because the adhesive on Velcro® tape is not always that aggressive, we suggest gluing the fuselage piece to the fuselage side with medium or thick CA glue.



□ 4) The receiver is now mounted in the fuselage on top of the battery tray, again using a 1-1/2" length of the provided Velcro®

tape. Like the ESC Velcro® tape, we, again, suggest using medium or thick CA glue to secure the tape to the battery tray.

□ 5) With the receiver now in place, the appropriate receiver connections can be made. Route the rudder and elevator servo leads up through the oval hole in the battery tray and plug the connectors into the rudder and elevator receiver receptacles. Now, route the receiver lead from the ESC up through the slotted hole in the battery tray and plug the connector into the receiver throttle channel receptacle. Last, plug the aileron Y-harness into receiver aileron receptacle.

□ 6) We routed our receiver antenna down through the hole opposite to the speed control lead and then fed it down along the inside bottom of the fuselage to the tail. At the tail, we secured the antenna end to the fuselage with a piece of tape.

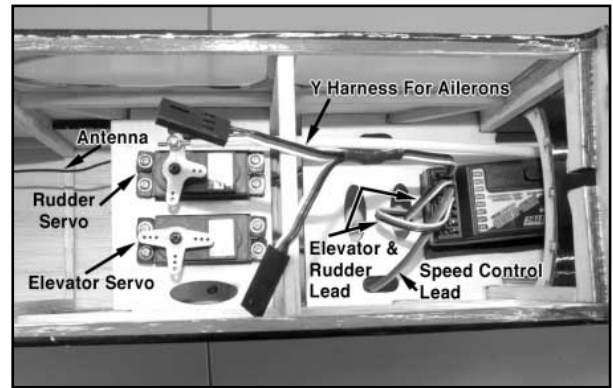

□ 7) The flight battery pack retention strap is now made and installed into the battery compartment. Cut a 5" length of Velcro® tape and then, separate the two pieces. Rejoin the two pieces of Velcro® with a 1-1/2 overlap. This overlapped area is now glued onto the battery tray as shown using medium or thick CA glue. The loose ends of the tape should be able to extend over your battery pack, securing it in place when the two ends are pulled tight. As shown, this retention strap can secure both 3-stack LiPo packs as well as the alternative 10-cell NimH flight pack.



□ 8) As shown, the battery pack access hatch is held in place with a nylon landing gear strap mounted to the fuselage bottom with a T2.6 x 12 mm PWA screw. Locate these two parts from your kit contents.

As shown, the mounting position of the nylon strap is centered on the bottom of the fuselage, 5/16" behind the battery hatch opening. Properly in place, the strap can be rotated 90°, pivoting on the screw, allowing the hatch to be removed for battery insertion or removal. Use a 1/16" bit to drill a pilot hole for the PWA screw

through the fuselage bottom at this location. Harden the pilot hole with a drop or two of thin CA glue. Establish the threads in the wood by screwing the PWA screw into the pilot hole and then remove it. Because the nylon landing gear strap must pivot on the screw, use a 5/32" bit to drill out one of the holes in the strap to allow clearance for the screw. Last, install the strap in place to the fuselage with the T2.6 x 12 mm screw. Tighten the screw just enough to keep the strap in position.

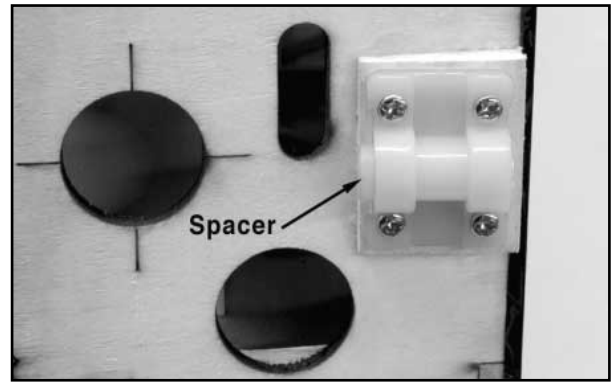
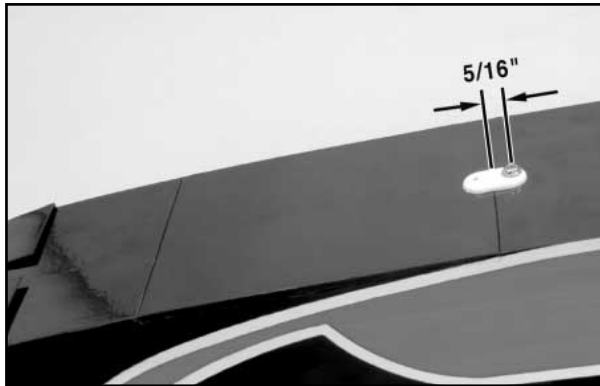

LANDING GEAR INSTALLATION:

In the following steps, you will install both the steerable nose gear and the main landing gear. Note that before you begin working with the provided wire landing gear forms, they should be inspected closely for any burrs at the ends. Use a Dremel® Tool or a small file to grind these off before proceeding.

From your kit parts, locate and have ready the following parts:

- 1 each Nose gear - pre-bent 4 mm wire
- 1 each 4.1 mm ID wheel collar with set screw
- 1 each 4.1 ID steering arm with set screw
- 4 each M3 x 15 mm Phillips head bolts
- 1 each Nylon nose gear bearing
- 1 each 1.5 mm hex wrench
- 2 each Main gear - pre-bent 4 mm wire
- 2 each Nylon landing gear retaining straps
- 4 each T2.6 x 12 mm PWA mounting screws
- 3 each 70 mm (2-3/4") wheels

□ 1) The nylon nose gear bearing assembly, the nylon steering arm, and the wire nose gear strut will be installed first.

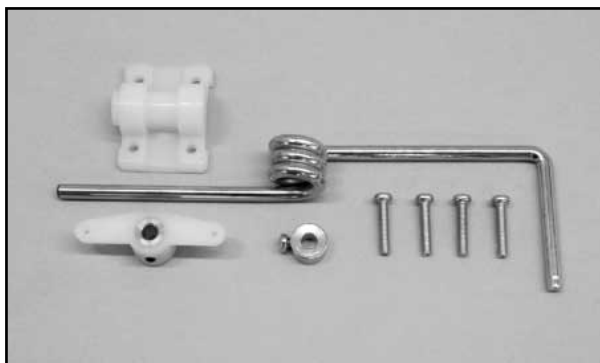

Note that this molded part has a spacer molded on one end. This spacer is the top of the bearing. When the bearing is correctly in place, this molded spacer is facing up toward the top of the fuselage, as shown. Install the nylon nose gear bearing to the bottom of the fuselage firewall, using the four provided M3 x 15 mm Phillips head bolts. Tighten these bolts firmly.

□ 2) The wire nose gear and nylon steering arm are now installed. Before installing the nylon steering arm, slide the 4.1 mm ID wheel collar onto the straight, unbent end of the nose gear wire, letting slide down to the spring for now. Insert the straight end of the nose gear wire into the bottom of the nylon nose gear bearing until the top of the wire emerges from the top of the bearing. As shown, place the nylon steering arm onto the exposed end of the wire at the top of the bearing, with its setscrew facing forward and the top of the wire flush with the top of the arm. With the parts in this position, rotate the wheel axle end of the wire to make it parallel with the firewall, with the spring wire form facing to the rear of the fuselage. Now, tighten the setscrew in the steering arm with the 1.5 mm hex wrench. Slide the wheel collar up to the nose gear bearing and tighten its setscrew, leaving just a slight amount of endplay for easy movement.

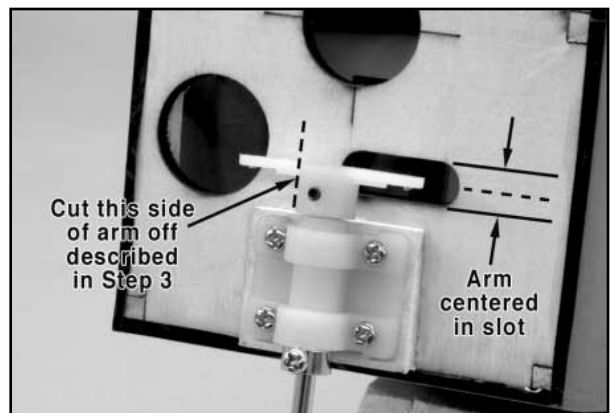

□ 3) With the nose gear assembly now in place, a simple precaution should be made to ensure that neither the steering arm or the wheel collar can slip out of position. We suggest using a Dremel® Tool or a small file to grind a small "flat" in the nose gear wire, directly at the setscrew locations.

Last, in order to obtain full, unobstructed movement of the nylon steering arm, we suggest that you remove arm that sits opposite of the slotted opening in the firewall. This is easily done with a single edge razor blade.

□ 4) Slide one of the 4 mm ID plastic bushings onto the nose wheel axle up to the 90° bend. Slide one of the 70 mm dia. wheels onto the axle and then, slide one of the wheel collars onto the end of the axle wire. Make sure the wheel turns freely with a minimum of endplay and tighten the wheel collar setscrew. Again, we suggest filing a small "flat" into the axle wire to better seat the setscrew

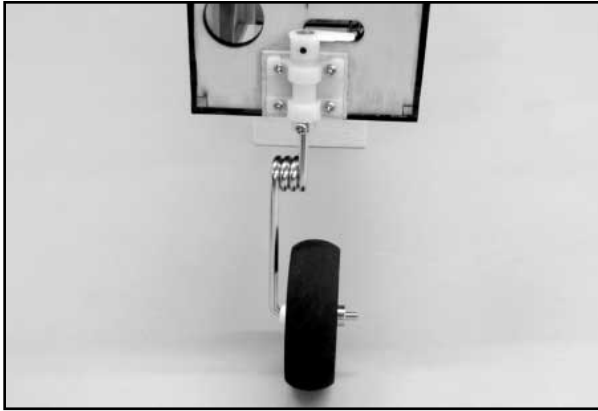

"flats" into the wheel axles, directly beneath the wheel collar setscrews.

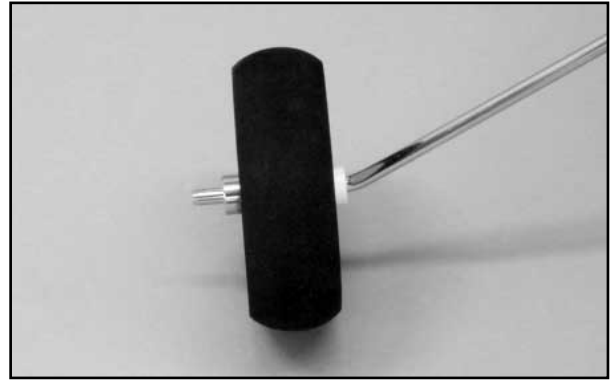

- 5) The main landing gear and wheels are now installed.

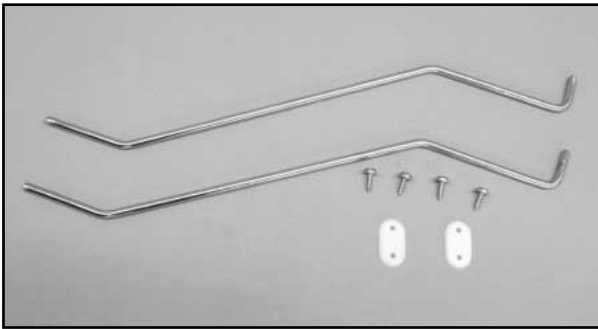

MOTOR INSTALLATION:

As mentioned earlier in the **MOTOR SELECTION** section of this manual, you will now have to have your own motor and ESC available for the following steps. As also mentioned earlier, the following steps show the installation of the HIMAXX #HC3522-0990 brushless outrunner motor. This HIMAXX motor also comes with a motor mount system and an appropriate propeller adaptor. If you have chosen a different motor, be aware that you will also need a propeller adapter and that you may have to depart from these steps to fit and mount it.

On the bottom of the fuselage, behind the battery hatch you will find a slot with a holes drilled on each side. Insert the short 90° bent end of the one of the 4 mm dia. main landing wire forms into one of these holes, pressing the adjacent straight part of the wire into the slot. Repeat this process with the remaining opposite landing gear wire. These wires should nestle down into the slot, flush with the bottom of the fuselage. Note that it might be necessary to slightly adjust the short vertical ends of the wire to get these two adjacent wires to lay correctly in the fuselage slot.

- 1) Following the instructions that came with your HIMAXX motor, assemble the motor to the mounting system and then, secure the propeller adaptor to the output shaft.

- 2) From the kit contents, locate the motor spacer bag containing the six 3 mm lite-ply spacer rings and the four T3 x 20 mm PWA mounting screws. The provided spacers are included for the purpose of moving the motor forward from the firewall to a distance of 3-5/8", measured from the back face of the spinner base to the firewall, as shown. In HIMAXX motor installation, all six spacers were required to obtain this measurement.

- 6) The two remaining nylon landing gear retainer straps are now used to retain the adjacent landing gear wires, as shown. Place one of the nylon retainers centered over the nested wire slot and use a sharp pencil to mark the mounting screw locations onto the fuselage. Use a 1/16" bit to drill two pilot holes for the screws. Repeat this process for the opposite retainer strap. Install the straps in place with four T2.6 x 12 mm PWA screws.

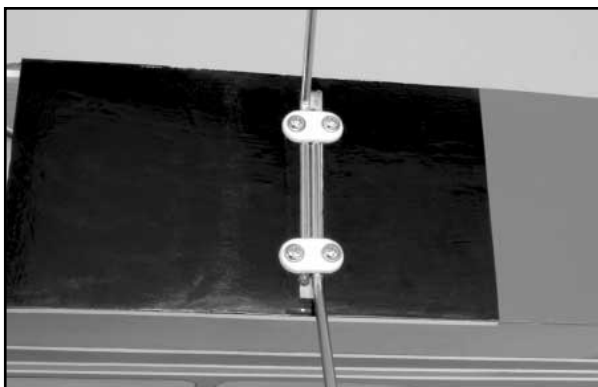
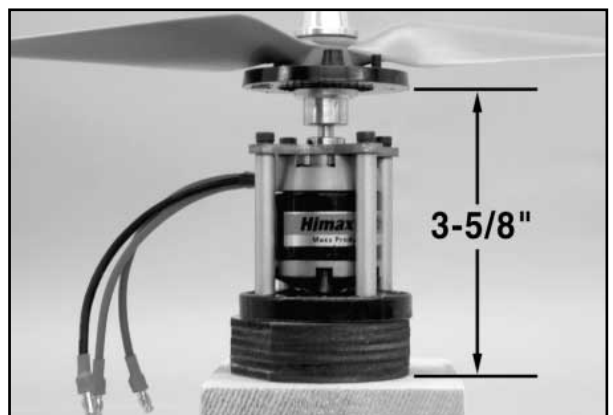

- 3) The spacer rings are now stacked and glued together, using epoxy glue. Note that the flat sections of each spacer must be aligned to provide clearance spacing for the nose gear steering arm. This is most easily accomplished by gluing the spacers to each other while holding the flat sections to a flat work surface.

- 7) Slide a 4 mm nylon spacer onto each wheel axle, up to the bend. Slide a 70 mm dia. wheel onto each axle, followed by a wheel collar. Tighten the wheel collars, leaving just enough wheel spacing to avoid binding. As before, we recommend filing small

- 4) When the glued spacer stack has cured, again use epoxy glue to glue the spacer assembly directly to the fuselage firewall with its center hole aligned with the center hole in the firewall and

with its flat section directly over the nose gear steering arm.

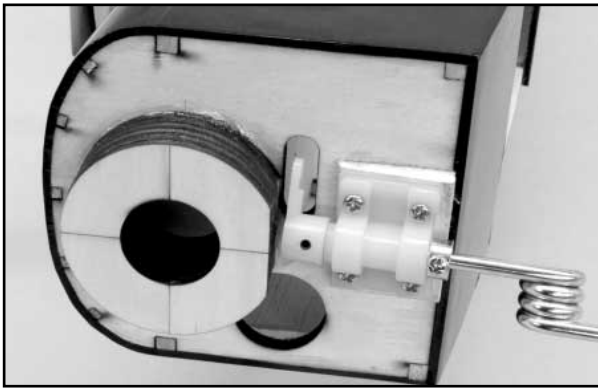

□ 5) Place the motor/motor mount assembly onto the face of the spacer assembly. Center it with the three motor wires oriented off to the right side where the round laser-cut wiring hole is located in the firewall. With the motor/motor mount assembly in this position, use a sharp pencil to mark the four mounting hole locations onto the face of the spacer assembly. Remove the motor and use a 1/16" bit to drill four holes into the spacer at the marks just made. Use the provided four T3 x 20 mm PWA screws to, now, mount the motor in place to the spacer assembly.

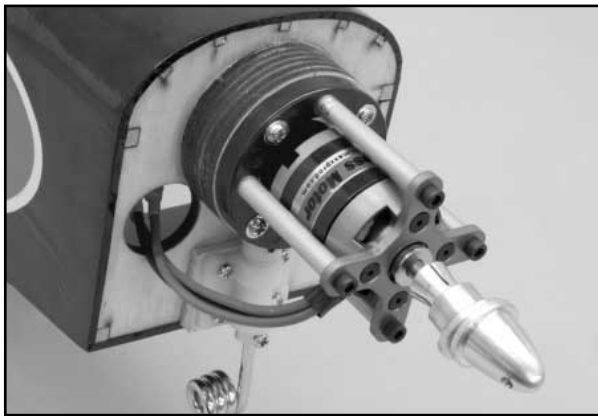

□ 6) The three motor wires from the ESC are now connected to the appropriate three wires from the motor, through the round laser-cut hole in the firewall.

IMPORTANT SAFETY NOTE: Do Not install a propeller to the motor until instructed to do so in this manual.

□ 7) Turn the transmitter on, with the throttle stick in the full off position. Plug a charged flight battery pack into the battery lead of the ESC. Slowly advance the throttle to check the motor for the proper direction of rotation. If nothing happens when the stick is advanced, reverse the throttle function switch in the transmitter and try again. The motor should rotate counter-clockwise when looking at it from the front. If it turns the wrong direction, reverse any two wires between the ESC and the motor. Once the motor responds in the correctly in relationship to the transmitter, disconnect the battery pack from the ESC and turn off the transmitter.

TAIL GROUP ASSEMBLY AND MOUNTING:

□ 1) Before mounting the stabilizer and vertical fin, there are three openings at the top rear of the fuselage, that must be opened. Two of these openings are just ahead of the uncovered

stabilizer saddle, at the top center. These openings will accept the mounting stubs at the bottom of the vertical fin. The third opening is the rudder pushrod slot on the left rear of the fuselage. Use a sharp #11 blade to neatly remove the covering material from these openings.

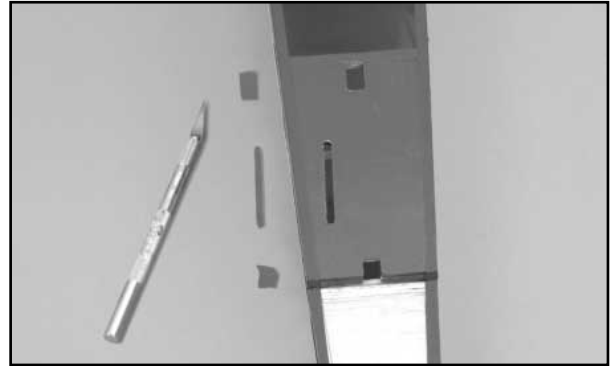

□ 2) The rudder is now hinged to the vertical fin and the elevators are hinged to the horizontal stabilizer. The method used for hinging these surfaces is exactly the same as the ailerons hinged earlier in this manual.

Starting with the rudder and fin, remove the three CA hinges from the fin and rudder. Reinsert the hinges back into the slots at the rear of the fin, with their die-cut slots parallel with the fins trailing edge. Cut and insert cardstock "wedges" into the slots in each of the three hinges. Install the rudder onto the three hinges, pushing it fully in place up to the card wedges. Carefully align the top of rudder with the top of the fin.

Flex the rudder in one direction or the other, about 1-1/2" and hold it in this position with a piece of tape. Remove the wedge from one of the exposed hinges and apply four drops of thin CA glue to the hinge - 2 drops on each side of the hinge slot. Repeat this process with the remaining two hinges. Remove the tape holding the rudder and flex the rudder over to the opposite side about 1-1/2". Use a piece of tape to hold it in this position and apply thin CA glue to the exposed hinges. Remove the tape and return the rudder to its centered position. Allow 10 minutes or so for the glue to fully wick. After sufficient time has passed, briskly flex the rudder to free up its movement.

Using the same methods, hinge the elevators to the horizontal stabilizer.

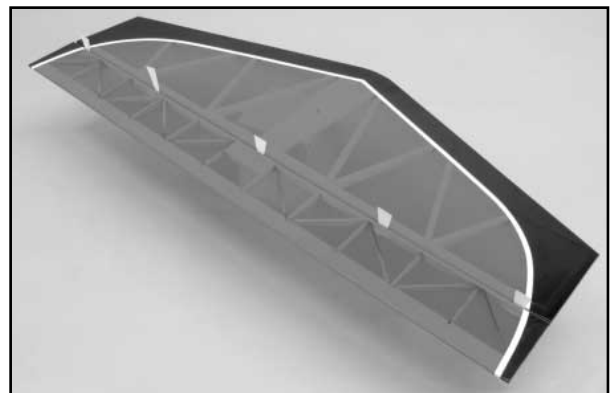

□ 3) Because it is much more convenient to attach the control horns to the rudder and elevators at this point, we suggest doing this now. As shown, the nylon rudder control horn is positioned on the left side of the rudder, at the bottom leading edge of the rudder.

Also as shown, its location is 3/8" up from the bottom of the rudder to the center of the horn. Align the four connection holes in the control horn arm with the hinge line. Use a sharp pencil to mark the location of the two mounting holes in the horn's base onto the rudder. Use a 1/16" drill bit to make two holes in the rudder at the marks just made - do not drill all the way through the rudder. Use a drop of thin CA glue into each hole to harden them. Mount the rudder horn in place to rudder with two T2 x 6 mm PWA screws.

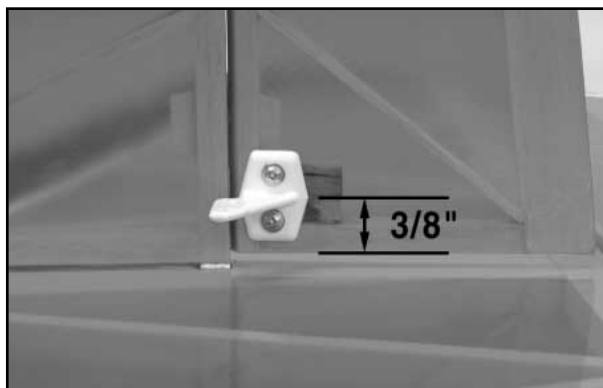

□ 4) The elevator control horn is attached to the bottom leading edge of the elevators at the exact centerline. The control horn is positioned on the bottom of the elevators with the arm facing forward and its connection holes aligned with the hinge line. Again mark and drill two mounting holes for the horn and harden the two holes with a drop of thin CA glue. Mount the horn in place with the provided T2 x 6 mm PWA screws.

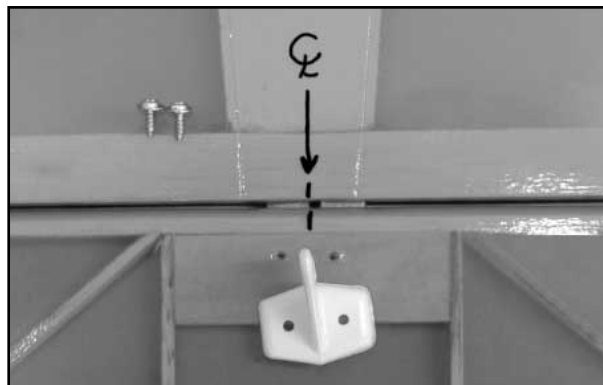

□ 5) To create the best wood-to-wood bond, the covering material on the bottom center section of the stabilizer needs to be removed. First, use a cloth-covered heat iron to firmly adhere the covering to the wood in the center section area. Place the stabilizer onto the fuselage at the rear and carefully center it. Use a non-permanent marker pen to trace the fuselage side locations

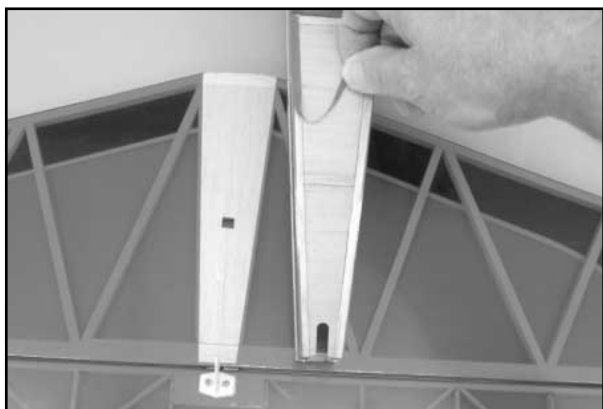

onto the stabilizer. Use a sharp #11 blade to lightly cut and then, remove the covering from the bottom center section of the stabilizer, trimming it approximately 1/16" inside of the marks just made. Likewise, trim away the excess covering material from the fuselage stabilizer platform, leaving about 1/16" or so of overlap.

□ 6) In preparation for gluing the stabilizer in place, first mount the wing to the fuselage with the two provided 10-32 nylon bolts. Doing this provides a good visual aid in aligning the stabilizer. Place the fuselage with the wing in place on a flat surface, allowing the model to be viewed accurately from either the front or rear. Support the bottom rear of the fuselage with blocks, magazines, etc.

With the fuselage now in this position, place the stabilizer onto the top rear of the fuselage and center it. Place a small weight onto the center of the stabilizer to hold it in place. Now view the model from the front or rear at a distance of 10 feet or so. The stabilizer should be squarely in place, without tilting to one side or the other. In the unlikely event that the stabilizer is tilted, remove it from the fuselage and use a sanding block to sand the fuselage stabilizer saddle on the high side to remedy the tilt.

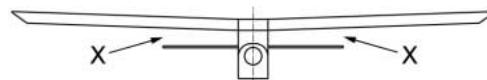

□ 7) Remove the stabilizer and mix a small amount of epoxy glue. Apply glue to the fuselage stabilizer saddle and also, apply a thin coat of glue to the bottom center of the stabilizer. Carefully place the stabilizer back on the fuselage, as squarely aligned as possible and hold it in place with a small weight. Using a yardstick, make sure the stabilizer is square with the fuselage by measuring from the trailing edge of the wing back to the leading edge tip of the stabilizer, on each side. Shift the stabilizer, as needed, to achieve the same measurement on each side. Any excess epoxy glue can be easily removed with a paper towel and a little rubbing alcohol, before the glue cures. Allow this assembly to fully cure.

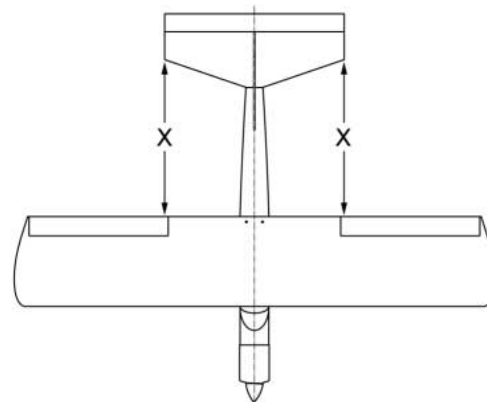

□ 8) The vertical fin and rudder assembly is now glued in place to the top of the stabilizer and fuselage. Begin by first placing the vertical fin in place, fitting the three bottom locating stubs into the three openings in the stabilizer and top rear fuselage. Hold the fin firmly in position and use a non-permanent fine-line marker pen to mark its location onto the fuselage and stabilizer. Remove the fin. As shown, the covering material is now removed from the fuselage and stabilizer to expose bare wood where the fin will be glued. Use a straight edge and a sharp #11 blade to lightly cut the covering away from the two fin locations lines just drawn. Cut the

covering approximately 1/16" inside each of these two lines.

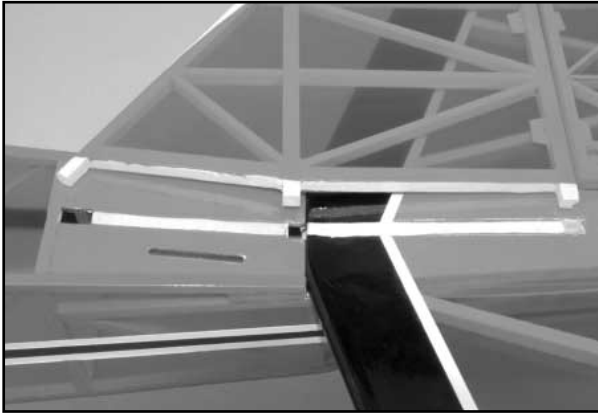

□ 9) Mix a small amount of 30-minute epoxy glue. Lightly coat the bottom surface of the fin and the locating stubs. Apply a small amount of glue to the exposed wood on the top of the stabilizer and fuselage. Carefully set the fin/rudder assembly in place onto the fuselage and stabilizer. Use a small square to set the fin at 90° to the stabilizer. Hold the fin in this position with a length of tape extending from one stabilizer tip, over the top of the fin and to the opposite stabilizer tip. View the model from the front or rear to make sure it is visually perpendicular to the fuselage, wing, and stabilizer. Make any required adjustments and allow the glue to fully cure. Any excess glue can be easily removed with a paper towel and a little rubbing alcohol. After the glue has cured, remove the wing from the fuselage

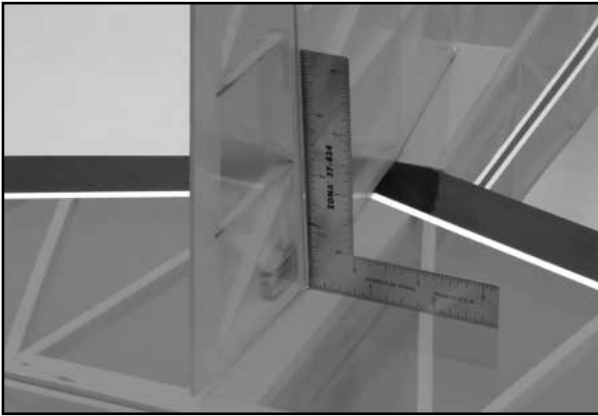

PUSHROD ASSEMBLY & INSTALLATION:

From the kit contents, locate the following parts:

- 1 each 3/8" x 15-3/4" (40 mm x 400 mm) Heat shrink tubing
- 1 each 5/16" dia. x 23-5/8" (8 mm dia. x 600 mm) Elevator pushrod dowel
- 1 each 5/16" dia. x 17" (8 mm dia. x 432 mm) Rudder pushrod dowel
- 1 each 2.6 mm x 200 mm rod threaded M2 on one end with an M2 nut and RC link and a 90° bend at the opposite end.
- 1 each 2.6 mm x 110 mm rod threaded M2 on one end with an M2 nut and RC link and a 90° bend at the opposite end.
- 2 each 2.6 mm x 100 mm rods threaded M2 on one end with an M2 nut and RC link and a 90° bend at the opposite end.

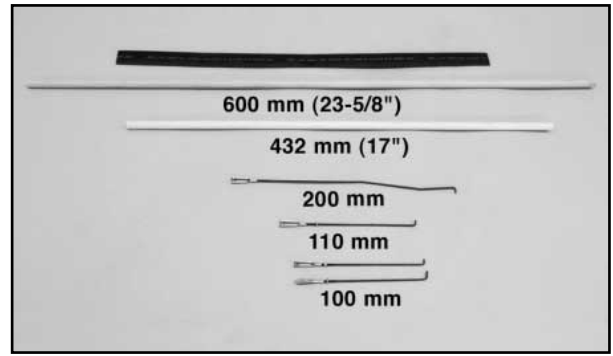

□ 1) The rudder pushrod assembly is made first. This pushrod will require the 17" wood dowel, the 200 mm threaded one end wire pushrod and one of the 100 mm wire pushrods with an RC link at one end. Note that the 17" wood pushrod is grooved and drilled at each end. These grooves are there to locate and nest the wire pushrods at each end. Also, note the 90° bends in the wire pushrods, made to fit into the pre-drilled holes in the wood pushrod.

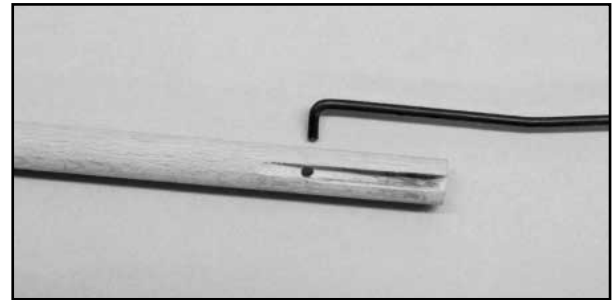

□ 2) Use 5-minute epoxy to glue the short 90° bent ends of each pushrod wire into the grooves and drilled holes on each end of the 17" wood pushrod.

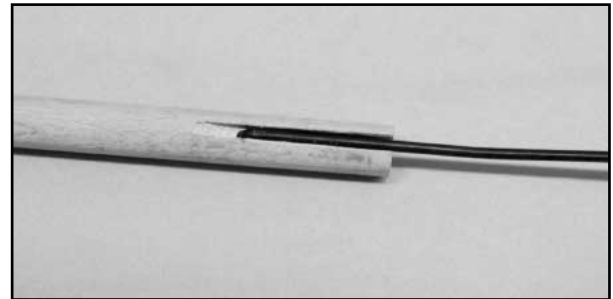

When the glue has cured, cut two 2" lengths of heat shrink tubing from the supplied material. Slip a piece of heat shrink tubing over the glued wire at one end of the wood pushrod and use a heat gun



to shrink it firmly over the wire and wood joint. Use the second piece of heat shrink tubing to cover and secure the opposite end of the pushrod.

□ 3) The elevator pushrod is now made in the same way, using the longer 23-5/8" wood pushrod dowel, with the 110 mm pushrod wire at one end and the remaining 100 mm pushrod wire with the RC link at the opposite end. The elevator pushrod will be installed last, it can be set aside for now.

□ 4) Remove the rudder servo output arm retaining screw and remove the output arm from the servo. Install the brass pushrod connector into the inside hole in the output arm and secure it in place with the lock washer. Reinstall the output arm back onto the servo perpendicular to the servo body with the pushrod connector aligned with the nose gear steering tube. Once the arm is in this position, replace the retaining screw.



□ 5) The rudder pushrod assembly is now installed. To feed the rudder end of the pushrod through the pushrod exit slot at the top rear of the fuselage, it is first necessary to remove the RC link and lock nut from the longer rear pushrod wire. As shown, slightly bend the pushrod wire up to access the pushrod slot from inside the fuselage.

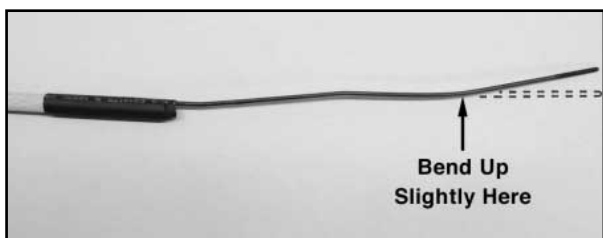

Insert the pushrod into the fuselage through the wing opening, guiding it back toward the tail. Maneuver the pushrod until the threaded pushrod end exits the slotted hole at the top rear of the



fuselage, next to the fin. Pull the wire out of the slot far enough to straighten out the bend that was just made. Thread the lock nut all the way onto the pushrod threads and then the RC link all the way onto the threads, leaving about 1/16" between it and the lock nut. At the servo end of the pushrod, again thread the lock nut all the way onto the threads, followed by the RC link. Install the RC link to the outermost hole in the rudder servo output arm. Now, lock the rudder in neutral to the vertical fin, using tape or clamps, as shown.

Now, thread the RC link at the rudder in or out as needed to connect it to the outermost hole in the nylon rudder horn.

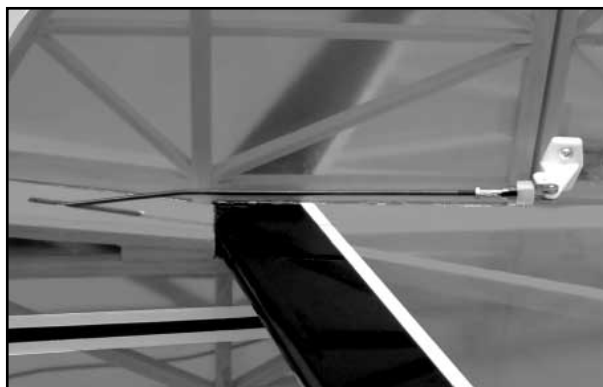

□ 6) With the pushrod now connected to both the rudder and the rudder servo, thread both lock nuts up to the rear barrel of the RC links and tighten them firmly. As shown, we installed short lengths - 1/4" or so - of fuel tubing over the RC links to hold them firmly in place.

□ 7) Now that the rudder pushrod is in place and connected, the nose gear pushrod is installed. From the kit contents, locate the following parts:

- 1 each 3 mm OD x 300 mm (1/8" x 11-13/16") nylon nose gear pushrod
- 2 each M2 x 24 mm threaded studs
- 1 each M2 RC Link
- 1 each M2 nut

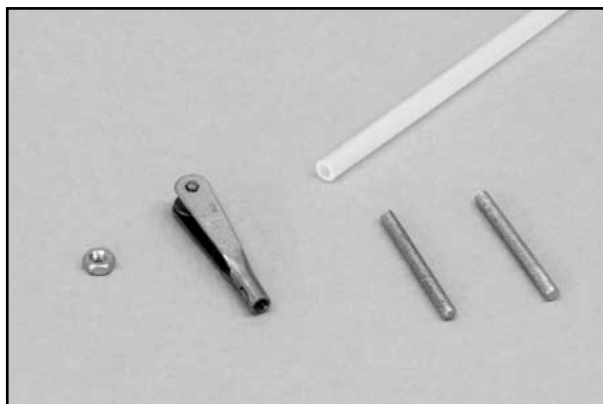

Thread one of the M2 x 24 mm studs into one end of the nylon pushrod tube to a depth of about 3/8". As shown, this is easy to do by using an electric drill. Chuck the stud firmly into the drill and then simply use the power of the drill to thread the stud in place into the nylon tube.

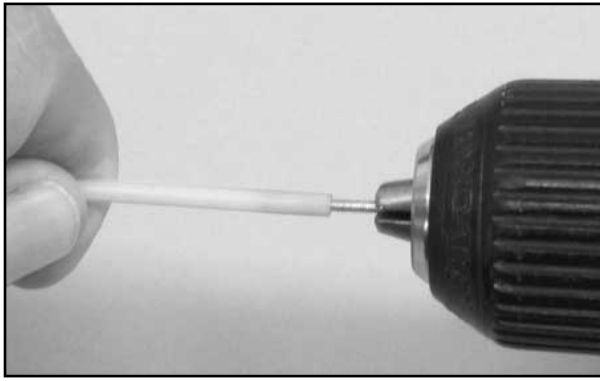

- 8) Thread the M2 nut fully onto the exposed end of the stud. Thread the RC link onto the stud far enough to expose a thread or two inside the link. Tighten the lock nut firmly against the rear of the RC link barrel. Insert the opposite end of the nylon pushrod through the slotted opening in the firewall and into the 5 mm pushrod housing tube. Slide the pushrod all the way in place until you can snap the RC link in place to the hole at the end of the steering arm.

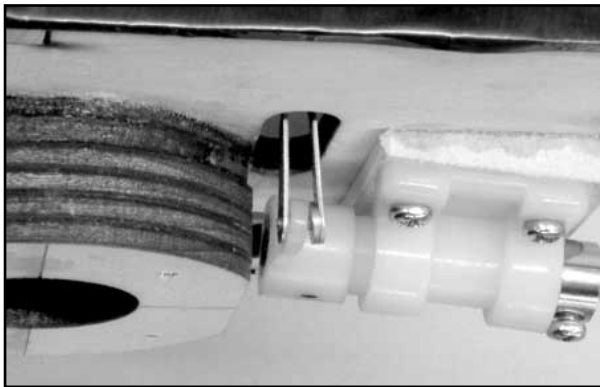

- 9) Use a piece of tape to hold the nose wheel in the centered (fore and aft) position. Turn your transmitter on and plug a flight battery into the ESC. In the servo compartment, you will see that the nylon nose gear pushrod is slightly longer than needed. Use a marker pen to mark the nylon tubing at a point about 1/4" away from the pushrod connector on the servo arm.

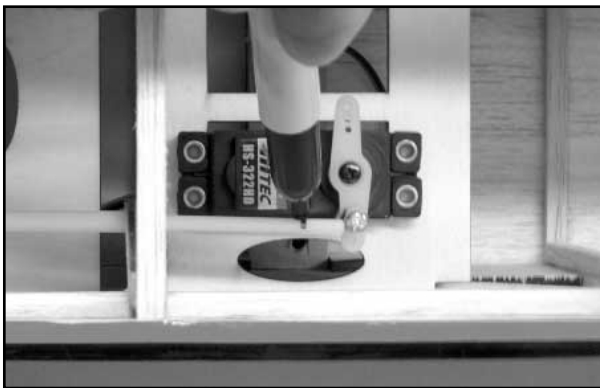

Remove the tape holding the nose wheel in place and disconnect the RC link at the steering arm and remove the nose gear pushrod tube. Cut the tube at the mark just made. Chuck the remaining M2 x 24 mm threaded stud into an electric drill and thread the stud into the servo end of the nylon pushrod tube to a depth of about 3/8". Reinstall the nylon pushrod tube through the firewall opening and back into the 5 mm pushrod housing tube. Reattach the RC

link to the steering arm. In the servo compartment, run the exposed end of the threaded stud into the hole in the pushrod connector. Center the nose wheel as closely as possible and tighten the setscrew in the pushrod connector.



Adjusting the nose wheel to allow the model to roll perfectly straight along the ground can now be accomplished by simply adjusting the nose gear pushrod at the pushrod connector on the rudder servo output arm. Unplug the flight battery and turn off the transmitter.

- 10) The elevator pushrod is now installed. Thread the M2 nuts onto each of the threaded wire pushrods at each end, followed by the two RC links. Be sure to note that the shorter wire end is the servo end of the pushrod. Thread the RC link on the longer rear pushrod wire about 1/2 way onto the threads. Lock the RC link in place by firmly tightening the M2 nut against its rear barrel. Slide a 1/4" length of silicon fuel tubing over the RC link, sliding it back to the nut.

Insert the elevator pushrod into the center rear opening in the fuselage, resting its servo end above and onto the servo tray. Attach the rear RC link into the outermost hole in the nylon elevator control horn. Slide the piece of fuel tubing up and over the two arms of the RC link.

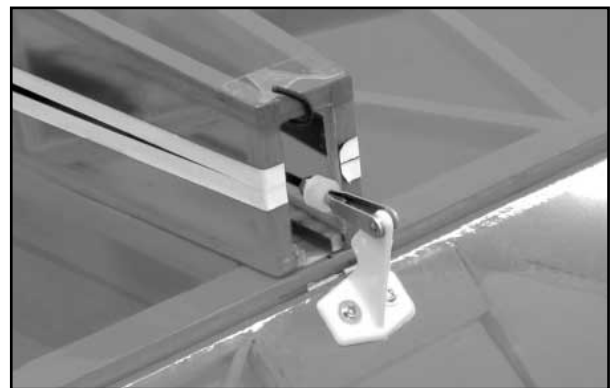

- 11) As you did with the rudder and fin, clamp the elevators in neutral to the horizontal stabilizer. In the servo compartment, thread and adjust the RC link as needed to fit easily into the outermost hole in the elevator servo output arm. Turn on the transmitter and plug a flight battery into the receiver. Test the action of the elevators and, if needed, adjust the positioning of the servo output arm on the servo to seat it perpendicular to the servo body. As shown, all of the linkages in the servo compartment have now been made and checked. Disconnect the flight battery pack and turn off the transmitter.

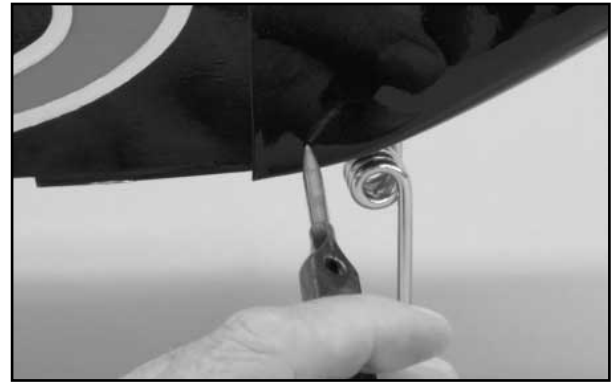

MOUNTING THE COWL, SPINNER, & PROPELLER:

For the following steps, locate the following parts from the kit contents:

- 1 each Molded and painted plastic cowl.
- 4 each T2.6 x 8 mm PWA screws
- 1 each 2" dia. black plastic spinner

In addition, you will also need to have the propeller that you plan to use available.

□ 1) Slide the cowl in place over the motor and nose gear wire, onto the nose of the fuselage. Use pieces of tape to hold the cowl as far onto the fuselage as it will go. Mount the rear spinner base onto the motor propeller adaptor, followed by the propeller. Mount the propeller in place to the propeller adaptor. Place the front spinner cone over the propeller and engage its base into the grooves molded into the spinner base. Secure the spinner fully in place to the spinner base with the provided self-tapping screws. Tighten the screws to fully seat the spinner cone.

□ 2) Remove the tape holding the cowl to the fuselage. Slide the cowl forward to within 1/16" - 3/32" of the rear face of the spinner base plate. In side view, the spinner should be approximately centered between the top and bottom curvatures of the front of the cowl. In top view, the cowl should be sitting squarely on the fuselage. This is the optimum mounting position for the cowl in relationship to the propeller and spinner.

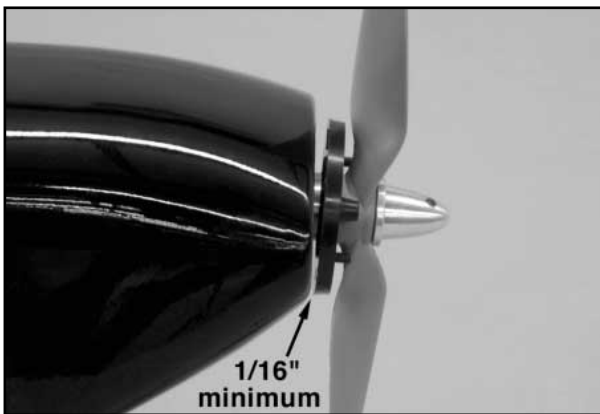

Use pieces of tape to firmly hold the cowl in this position. Use a 1/32" bit to drill four pilot holes through the pre-drilled holes in the cowl, into the fuselage. Use the four provided T2.6 x 8 mm PWA screws to now mount the cowl in place to the fuselage.

□ 3) Remove the spinner and propeller from the motor. Remove the cowl from the fuselage. "Harden" the four cowl mounting holes in the fuselage with a single small drop of thin CA glue in each hole. Remount the cowl to the fuselage with the four mounting screws.

□ 4) The propeller and spinner can now be final-mounted to the motor propeller adaptor. Note that when trying to tighten the propeller nut, the spinner backplate may slip against propeller shaft adaptor on the motor, allowing the propeller to slip out of position. If this happens, remove the propeller nut and spinner backplate and glue a small disk of coarse sandpaper (80 - 100 grit) on the front of the propeller adaptor flange. Then, assemble the parts as before and tighten the propeller nut firmly.

Be sure to align the propeller correctly against the molded studs on the spinner base plate. This allows the spinner cone to correctly engage to mounting grooves. Once these parts are in the proper position, the spinner cone can be snugged in place with the mounting screws.



SAFETY WARNING: Now that the propeller is mounted to the motor, it is very important that you always remain aware of the position of the throttle stick on your transmitter, whenever a battery pack plugged into the airborne system. The typical motor unit used in this model is powerful enough to cause damage to people or property if it is activated prematurely, accidentally, or unexpectedly. With electric model aircraft, we always urge you to get in the habit of always keeping the throttle stick in the full "low position" even when the transmitter is in storage. Be sure to always check the throttle stick position before plugging the airborne battery into the ESC. Under no circumstances should you hold this model by the nose when the battery is plugged in to the ESC. Never plug the battery pack into the ESC until you are on the flight line and ready to fly.

MOUNTING THE WINDSHIELD:

Packaged with the windshield is a small plastic bag containing six T2 x 8 mm PWA screws. Note that the windshield has been pre-drilled with six mounting holes. Fit the windshield in place onto the top front of the fuselage. Use pieces of tape to hold the windshield firmly in place, without covering the mounting holes. Use a 1/32" bit to drill six pilot holes through the pre-drilled holes in the windshield and into the fuselage. Remove the windshield and carefully apply a single small drop of this CA glue into each drilled pilot hole. Install the windshield in place using the six mounting screws.



DECAL APPLICATION:

The decals supplied with the Seniorita EP ARF are printed on Mylar® with an aggressive adhesive on the back side. They are not water slide type decals. These decals are not die-cut and must be removed from the carrier sheet using a hobby knife with a sharp #11 blade and/or scissors.

The smaller decals can be easily applied to the model by simply removing the paper backing sheet, and then, carefully laying the decal in position and pressing it in place with your finger. However, for the larger decals, such as the "SENIORITA EP" wing decal, we suggest the following method of application.

Carefully cut out the decal and lift it off of the sheet with tweezers. Use a product such as SIG Pure Magic Model Airplane Cleaner or Windex® to spray the wing panel where the decal will be applied. Then, spray the adhesive side of the decal itself. Lightly position the decal in place onto the wing panel. The liquid cleaner allows the decal to slide easily into the desired position - do not press down on the decal. Once in position, hold the decal lightly in place with your finger and use a paper towel to gently dab the excess liquid away. Use a small squeegee to now set the decal in place, removing all excess liquid and any trapped air bubbles. The SIG 4" Epoxy Spreader - #SIGSH678 - is perfect for this job. Mop up any excess cleaner with a dry cloth and allow the decals to set



overnight. They will be solidly adhered to the model without any air bubbles.

CONTROL SURFACE TRAVEL:

The maximum distance that a control surface moves when you move the transmitter stick to full deflection is called the "control throw" or "control travel". This determines how responsive the airplane will be to your control inputs. We suggest the following control movements for beginning R/C pilots.

Ailerons: 3/4" (19 mm) up - 3/4" down
Elevator: 5/8" (16 mm) up - 5/8" down
Rudder: 1" (25 mm) left - 1" right

Note: These measurements are always taken at the widest part of the control surface, at the trailing edge.

Adjust these throws as mechanically close as possible by trying different connection points for the pushrods at the control horns. It is best to start out in the outer holes of the servo output arms and the outer holes of the control horns. If you have too much surface throw or movement with the pushrods in these outer holes, move in one hole at the servo output arm. If you need more throw, move the RC link in one hole at the control horn. With a computer type transmitter that has an EPA (End Point Adjustment) feature, the adjustment and fine-tuning of the flight control servos becomes much more easy to adjust. Always set the transmitter control movements at 100% before making any mechanical adjustments.

CENTER OF GRAVITY:

Establishing the correct Center of Gravity (C.G.) on this or any other R/C model airplane is critical to its ultimate success in the air. The recommended starting balance point for the Kadet Seniorita EP ARF is located at 3-1/4" (82.5 mm) behind the leading edge of the wing. This is the location of the main wing spar. We do not recommend trying to fly this model with a C.G. further back than this location, as it is likely to make the elevator (pitch control) very sensitive. **IMPORTANT:** You should always balance the model with your flight battery installed. It is a simple matter to shift the battery pack fore or aft to adjust the balance point as needed.

A simple balancing fixture, such as two dowels with rubber tips to protect the finish, is the most accurate method for determining and then, adjusting the correct C.G. location. As shown, use two pieces of tape on the side of the fuselage, just beneath the wing, to mark the 3-1/4" C.G. point. Later, after balancing the airplane, the tape can be removed.

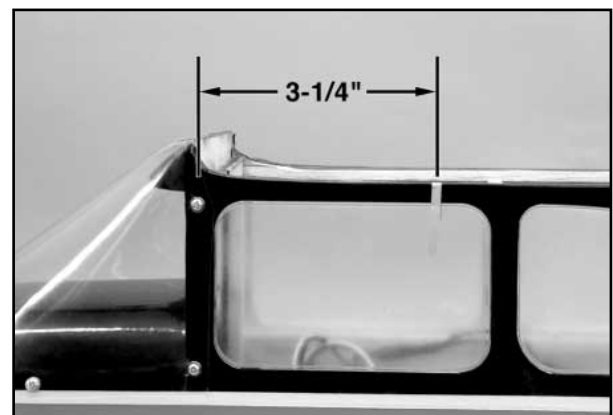

If you don't have a balancing fixture, enlist a friend to pick up the airplane at one wingtip while you support the other, using the main

spar as the point of balance.

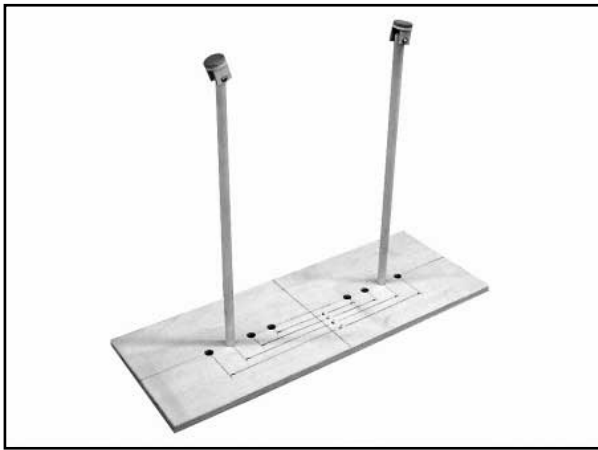

Properly balanced at the 3-1/4" point, the airplane should hang perfectly level. If the nose is down, the airplane is nose heavy. Likewise, if the tail hangs down from level, it is tail heavy. If either of these conditions exist, they must be corrected.



If the model is just slightly nose heavy; it can be safely flown. However, if it is very nose heavy, shift the flight battery pack battery to the rear until proper balance is achieved. Mark this battery pack location on the battery tray. This allows you to install the battery pack in the same location each time you fly the model.

If the model is tail heavy, the battery pack should be shifted forward as needed to achieve proper balance. If the battery pack is as far forward as it can go and the model still needs more weight to balance, several things can be done to achieve this:

- Heavier, after-market nose wheel
- Heavier, larger capacity battery pack
- Heavier, after-market spinner
- A brass "Heavy Hub" propeller nut - made by Harry Higley Products

Because the Seniorita EP ARF design has so much wing area, adding such weight will do little to degrade its flying ability.

AN INSTRUCTOR CAN SAVE YOUR AIRPLANE!

The SIG Kadet Seniorita EP ARF has been designed to fly as easily as any trainer type model ever designed. The gentle flying characteristics are there to give the beginning R/C modeler plenty of time to think about the next control input without constantly having to correct the flight path. However, as we have mentioned earlier in the introduction section of this manual, if you are a new beginning R/C pilot, **DO NOT** attempt to fly this airplane yourself!

Seek out and use a qualified R/C aircraft instructor. There are hundreds of R/C clubs in the U.S. and these clubs typically have designated instructors, who are eager to help newcomers. The easiest way to find an R/C flying club is to ask your local hobby shop or check the AMA (Academy of Model Aeronautics) web site: www.modelaircraft.org.

Also, be aware that the Kadet Seniorita EP ARF is a large airplane, requiring an appropriate amount of runway. This airplane should NEVER be flown in backyards, parks, or within five miles of an AMA sanctioned radio control model flying site. This simple precaution can prevent the loss of your model from radio interference. Do yourself a favor and join your local R/C club. You will almost always get assistance and good advice and you might even make a new friend or two.

An R/C flight instructor serves two important functions. First, he will test fly your new airplane to make sure it is performing correctly, before you try to fly it. These first flights are called "trim flights". During these flights, the flight instructor will "trim" the model from the transmitter to ensure that it flies straight and level without any problems. When a brand new R/C model takes off for the first time, there is no way of knowing which way it might want to go. Some models will try to climb, while others might want to go down. Some will try to turn left, some right. Some models will be doing both at the same time! It doesn't mean that there is anything wrong with the model, or as the novice says; "the wind got me". These minor differences must be "trimmed out" in order for the model to fly "hands-off" straight and level. An experienced pilot can quickly correct out of trim conditions before the model crashes into the ground. An inexperienced beginner has almost no chance of saving an out of trim model!

The second reason for having an instructor is to have someone there to correct the mistakes you will make during the learning process. It isn't that flying an R/C model aircraft is all that difficult. It is more a matter of learning what to do and when to do it. No matter how slowly a model flies, an incorrect control input may produce almost instant problems that, in turn, demand almost instant correction. This is especially true when at low altitude, such as take-offs and landings. A good flight instructor will climb the model to an altitude, that gives him a good chance of saving your model when you make the inevitable mistakes. This altitude is generally referred to as "2 mistakes high". When you get in trouble, quickly hand the transmitter back to the instructor so he can save the airplane. He'll level the airplane, get it back up to altitude and then, let you try it again. Without an instructor, it is very likely that you would not receive this second chance.

Beginning R/C pilots almost always over control their models. This is very normal but a trait that must be cured during instruction. Another common problem for beginners is disorientation. For example, when the airplane is flying away from you, right aileron input produces a right turn and left aileron produces a left turn. However, when the airplane is flying directly towards you, the same right aileron makes the airplane appear to turn left! This perceived reversal is very confusing to all first time R/C pilots! Without an experienced flight instructor on hand, it will most likely cause the loss of the model.

With a flight instructor, these early learning problems can be easily dealt with. The more you fly, the quicker you will learn. You will soon "solo" and begin to really enjoy your model. Remember, the first time you tried to ride a bicycle? It seemed completely awkward the first time, but once you learned how, it became easy.

Don't be discouraged if you have a minor crack-up. Just repair the damage and get back in the air, as soon as possible.

PRE-FLIGHT:

Before heading to the flying field, be sure your transmitter and airplane batteries are fully charged. We suggest that you create a simple checklist of those items, that you will need to take to the flying field, such as the transmitter, all appropriate tools, fast charger for the airplane battery pack, cleaning solution, rags or paper towels, flying cap, sun glasses, etc.

Ask your instructor to completely inspect your airplane to make sure it is flight-worthy. This little bit of insurance can go a long way in making your airplane last and safe to fly. At the flying field, one of the first things to do is to perform a range check with your radio system. This is simple precaution has saved many airplanes from being lost due to a problem within the radio system. Use and follow the range check procedure and instructions provided in the user's manual for your particular radio. Also, run the motor at different speeds, while performing the range test to make sure the motor is not making electrical noise, disrupting the radio link to your system. The controls should be solid with no erratic movements. If you find any of the controls being somehow affected by the motor, shut the motor down and find the problem. Do not attempt to fly your airplane with a radio problem! No amount of wishful thinking will make such problems disappear, especially in the air.

FLYING:

The Seniorita EP ARF appeals to R/C fliers of all experience levels - from beginners to expert pilots. Assuming that expert pilots will not need much guidance, these flying notes are written for the R/C newcomer. Because of its large size and relatively light wing loading, the Seniorita EP ARF is best test flown in light or no wind conditions, especially when learning to fly. These conditions tend to be the best for test flights because the airplane can be much more easily and accurately trimmed.

With the flight battery not plugged into the ESC, carry your model out to the flight box location. Turn the transmitter on and make sure the throttle stick is in the full low throttle position. Now, plug the flight battery into the ESC and secure the battery hatch. Test the controls to confirm that left is left, right is right and up is up. Taxi the model out to the center of the runway, lining it up with the center of the runway with the nose facing directly into the wind. Advance the throttle smoothly (do not slam it wide open all at once) to get the model rolling forward. Make *small* rudder/nose wheel corrections, as needed to keep the airplane pointed straight down the middle of the runway. As speed builds and the airplane becomes "light", it is at flying speed. Smoothly apply a little up elevator for lift off. Keep the wings level with small aileron corrections and continue a *shallow* climb to altitude. Once the airplane is about 100' or more in the air, throttle back to a reasonable cruising speed and begin making any required trim corrections with the transmitter. The goal is to trim the airplane for "hands off" level flight at cruising speed. Note that like most trainer type aircraft using a flat bottom airfoil section, the Seniorita EP ARF will tend to climb under full power. This is perfectly normal and is what makes the airplane want to return to stable flight if upset. Many full-scale pilots use this characteristic to control altitude, using just the throttle. Because of its large, high lift wing, the Seniorita EP ARF is capable of maintaining level flight at very low airspeeds. This is a great characteristic when learning how to fly an R/C model because low airspeed provides plenty of time to think ahead of the airplane.

After the airplane is trimmed to your liking and while still at altitude, throttle back completely to stop the motor and get a feel for the glide characteristics. Also, in order to avoid any surprises during landing, it is a good idea to try a couple of stalls, while at altitude. Do this while the motor is off by steadily increasing "up" elevator input until the nose finally drops. You should find that the Seniorita EP ARF stalls cleanly, simply dropping the nose and resuming normal flight.

The Seniorita EP ARF is capable of mild aerobatics, such as both slow and barrel type rolls, stall turns, loops, Immelmans, inverted flight, etc. However, the design is really all about training beginning pilots, not competing in IMAC contests. As a trainer, it would be hard to find an equal.

Landing the Seniorita EP ARF is really easy as long as you understand that the large wing will keep it flying longer than most other trainers. Remember to use the throttle to control your rate of descent and avoid over-controlling the elevators. With practice, you'll be able to land the Seniorita EP ARF very accurately and at very low speeds. Always remember to keep the wings level during the final approach and use a little up elevator to flair just before touchdown. The Seniorita EP ARF landing gear system works well in damping less than perfect landings. However, you should be aware that landing an R/C model airplane tends to be the most difficult thing for beginning pilots to master. Not that it's hard to get the airplane down - it will *always* come down - but getting it down when and where you want it and being able to fly it again on the same day is the trick. This is where a good flight instructor can be especially helpful in your learning curve. Remember - **Takeoffs are optional, landings are mandatory!**

Last, you should never land your model in tall grass or weeds with the motor running. Always throttle back completely before touching down or if the model overturns. Tall grass or a nose over can stall a running motor and, in turn, this can overheat the ESC and batteries, potentially causing them to fail.

We sincerely hope that your Kadet Seniorita EP ARF model will be a great first R/C airplane and that you will go on to enjoy the many, many wonderful aspects of the sport and hobby of R/C model aircraft. Please remember to always operate your airplane in a safe, responsible manner with constant regard to safety, other flyers, spectators, and property.

GOOD LUCK AND HAPPY LANDINGS!

WARNING! THIS IS NOT A TOY!

Flying machines of any form, either model-size or full-size, are not toys! Because of the speeds that airplanes must achieve in order to fly, they are capable of causing serious bodily harm and property damage if they crash. **IT IS YOUR RESPONSIBILITY AND YOURS ALONE** to assemble this model airplane correctly according to the plans and instructions, to ground test the finished model before each flight to make sure it is completely airworthy, and to always fly your model in a safe location and in a safe manner. The first test flights should only be made by an experienced R/C flyer, familiar with high performance R/C aircraft.

The governing body for radio-control model airplanes in the United States is the **ACADEMY OF MODEL AERONAUTICS**, commonly called the **AMA**. The **AMA SAFETY CODE** provides guidelines for the safe operation of R/C model airplanes. While AMA membership is not necessarily mandatory, it is required by most R/C flying clubs in the U.S. and provides you with important liability insurance in case your R/C model should ever cause serious property damage or personal injury to someone else. For more information, contact:

ACADEMY OF MODEL AERONAUTICS
5161 East Memorial Drive
Muncie, IN 47302
Telephone: (765) 287-1256
AMA WEB SITE: www.modelaircraft.org

CUSTOMER SERVICE

SIG MANUFACTURING COMPANY, INC. is totally committed to your success in both assembling and flying the KADET SENIORITA EP ARF kit. Should you encounter any problem building this kit or discover any missing or damaged parts, please feel free to contact us by mail or telephone.

SIG MANUFACTURING COMPANY, INC.
P.O. Box 520
401-7 South Front Street
Montezuma, IA 50171-0520 USA

PHONE: 1-641-623-5154
FAX: 1-641-623-3922

SIG WEB SITE: www.sigmf.com
SIG E-MAIL: mail@sigmf.com

LIMIT OF LIABILITY

The craftsmanship, attention to detail, and actions of the builder/flyer of this model airplane kit will ultimately determine the airworthiness, flight performance, and safety of the finished model. SIG MFG. CO.'s obligation shall be to replace those parts of the kit proven to be defective or missing. The user shall determine the suitability of the product for his or her intended use and shall assume all risk and liability in connection therewith.

MORE GREAT PRODUCTS FROM SIG MANUFACTURING COMPANY!

PRO-BALANCER

Pro-Balancer
Order No. SH900



SIMtransmitter

SimTransmitter
Order No. RCSSIM062

SIG CA GLUE

THIN • MEDIUM • THICK

