



# RASCAL FORTY

ALMOST READY TO FLY



## RASCAL FORTY ARF ASSEMBLY MANUAL

### INTRODUCTION:

SIG's RASCAL FORTY ARF represents the classic good looks and lines of yesterday's private aircraft designs with performance that meets and even exceeds today's standards. The RASCAL FORTY is unlike any .40 size high-wing design available and offers flight characteristics that are equally unusual for such aircraft. The airplane is not just easy to fly, it's almost immediately "comfortable" to most R/C pilots. The look is decidedly from the "Golden Era" of aviation and yet the RASCAL FORTY ARF looks right at home on any modern flight line!

The RASCAL FORTY ARF has a lot more going for it than just its good looks. Its performance is as remarkable as its appearance. High speed is impressive and low speed is awesome and what goes on in between is just about as much fun as you can handle. The RASCAL FORTY could easily fill the role of a trainer and then be flown as your second airplane. Set the control throws at the suggested beginning movements, throttle back and learn to fly with a truly honest, gentle airplane. When you get through basic training and comfortable with the requisite take-offs, landings, and basic flight maneuvers, dial-up the control throws a little to enjoy a very aerobatic airplane. Inside and outside loops, rolls, inverted flight, snap maneuvers, great spins, and even knife-edge flight are all in the RASCAL FORTY flight envelope. Landings and take-offs are just about the smoothest you'll ever experience, even when compared to tricycle landing gear equipped aircraft. As the saying goes, "real pilots fly tail-draggers".

The RASCAL FORTY ARF kit has been engineered to get you into the air quickly as possible with an R/C model that will truly last. The airframe has been expertly built and covered with AeroKote™. This material is both rugged and easy to repair. The covering trim scheme is totally unique and also offers good visibility and orientation in the air. The two-piece wing allows convenient transportation in the smallest of vehicles.

This assembly manual has been specifically sequenced to get your RASCAL FORTY ARF assembled and into the air very quickly. We strongly suggest that you read through the manual first to get familiar with the various parts and their assembly sequences. The proper assembly and flying of this aircraft is *your* responsibility. If you are new to the sport/hobby of radio control, we urge you to seek the assistance of a qualified person to help you assemble this model airplane. If you do not understand a

particular assembly step or sequence, **do not** guess - find qualified help and use it.

### RADIO EQUIPMENT:

The RASCAL FORTY ARF requires a standard 4-channel radio system and five standard servos. We have used and can highly recommend both the Airtronics™, RD-6000 Sport system and the Hitec™ Flash 4X system. Both of these very affordable and reliable radio systems offer all the features you'll need for this and the many other R/C aircraft in your future. For reference, this assembly manual shows the installation of the Airtronics™, RD-6000 Sport radio system with Airtronics™, #94102 standard servos. In addition, you will need two aileron 24" servo lead extensions and an aileron servo Y-harness for connection to the receiver.



### ENGINE SELECTION:

Engine choices for the RASCAL FORTY ARF are many. Keep in mind that the airplane has been designed to be light, producing a very favorable wing loading. The design is also relatively aerodynamically clean. These two factors result in great performance when using the recommended engine sizes. Overpowering this model is totally unnecessary and not at all recommended.

We've found that the RASCAL FORTY ARF really comes into its own when flown with 4-stroke engines in the .40 - .52 displacement range. We've test flown the RASCAL FORTY with virtually every available 4-stroke engine in this range with outstanding results. The airplane just seems to fly wonderfully with 4-stroke engines. It just looks and sounds "right" with a 4-stroke in the nose.

2-stroke engines also fly this airplane very nicely. Any plain-bearing or bearing equipped .36, .40, or .46 sport engine would be a good choice. For example, a great choice would be the Irvine .40 engine. Like all Irvine engines, the .40 is powerful, reliable, and quiet. Whatever engine you choose, take the time to carefully break it in according to the manufacturer's instructions. A good running, reliable engine is a minimum requirement for the enjoyment of this or any R/C model aircraft.

### COVERING MATERIAL:

Your RASCAL FORTY ARF has been professionally covered using AeroKote™. This material is well known for its ease of application, light weight, and consistency of color. If you live in a dry climate, you may notice that some wrinkles might develop after removing the covered parts from their plastic bags. This is perfectly normal

in low humidity climates. Your model was built and covered in a part of the world with relatively high humidity and therefore the wood was likely carrying a fair amount of moisture. When exposed to drier air, the wood typically loses this moisture, dimensionally "shrinking" in the process. In turn, this may cause some wrinkles. However, wrinkles are easy to remove by just using a hobby type heat iron.

We suggest covering the iron's shoe with a thin cotton cloth, such as an old T-shirt, to prevent scratching the film. The iron should be set to about 220° - 250° F, (104° F - 121° C). Use the heated iron to lightly shrink the material - do not press on it. Then lightly iron the material back down to the wood. You can also use a hobby-type heat gun to re-shrink the covering but you must be careful around seams or color joints. Re-heating seams may cause them to "creep", making them unsightly. This is especially true with the RASCAL FORTY inset trim scheme. You must also be careful when using a heat iron or heat gun when working around the windshield and side windows - heat will distort this clear plastic material.



For part number reference, your RASCAL FORTY ARF was covered in AeroKote™ film with the following part numbers: #SIGSTL100 White and #SIGSTL010 Transparent Red or #SIGSTL050 Transparent Blue.

**REQUIRED TOOLS:**

For proper assembly, we suggest you have the following tools and materials available:



A selection of glues - SIG Thin and Thick CA and SIG Kwik-Set 5-Minute Epoxy  
 Clear Dope For Fuel-Proofing Engine Cut-Outs  
 Threadlock Compound, Such as Loctite® Non-Permanent Blue  
 Screwdriver Assortment  
 Pliers - Needle Nose & Flat Nose  
 Diagonal Wire Cutters

Small Allen Wrench Assortment  
 Pin Vise for Small Dia. Drill Bits  
 Hobby Knife With Sharp #11 Blades  
 Scissors  
 Heat Iron and Trim Seal Tool  
 Masking Tape  
 Paper Towels  
 Small Power Drill With Selection of Bits  
 Dremel® Tool With Selection of Sanding and Grinding Bits  
 A soldering iron and solder may also be required.

**COMPLETE KIT PARTS LIST:**

The following is a complete list of all parts contained in this kit. *Before* beginning assembly, we suggest that you take the time to inventory the parts in your kit. Note that the hinges for the rudder and fin are in place in the bag containing these two parts. The rudder/fin hinges are not glued in place yet. Please note that the nuts and bolts required to mount your engine to the aluminum motor mounts are not included in this kit and must be purchased separately.

**BASIC AIRCRAFT PARTS:**

- 1 each Fuselage
- 1 each Wing Panel Set, Ailerons Installed and Pre-Hinged
- 1 each Horizontal Stabilizer & Elevator Set, Pre-Hinged
- 1 each Vertical Fin & Rudder Set

**SUB ASSEMBLIES:**

- 1 set Fiberglass Wheel Pants, 1 Left, 1 Right, Pre-Painted
- 1 each Hardened Aluminum Landing Gear, Pre-Drilled
- 2 each 2-3/4" Dia. Main Wheels - "Lite"-type With Plastic Hubs
- 1 each 2-1/2" Dia. SIG Spinner Assembly, White, With Adapters & Hardware
- 1 each Fuel Tank Assembly, 260cc (8.8 oz.) With All Fittings
- 1 each Tailwheel Assembly:
  - 1 each Aluminum Tail Wheel Bracket, With Wheel Assembly
  - 2 each Centering Springs
  - 2 each #2 x 10mm (3/8") Phillips/Washer Head Screws
  - 3 each #4 x 10mm (3/8") Phillips/Washer Head Screws
  - 1 each Aluminum Control Horn For Centering Springs
- 1 set Adjustable Aluminum Motor Mount Assembly:
  - 2 each Aluminum Mounting Plates - 1/8" x 7/16" x 2-3/4"
  - 4 each M3 x 20mm (3/4") Phillips Head Bolts
  - 4 each M3 Washers
  - 4 each M3 Split Ring Washers

**PLASTIC PARTS:**

- 1 set Molded Clear Plastic Left & Right Side Windows
- 2 each White Plastic Aileron Hatch/Servo Mounts - 1 Left, 1 Right
- 2 each #10-32 x 1" Slotted Head Nylon Wing Bolts
- 4 each Nylon Control Horns - Ailerons - 2, Elevators - 1, Rudder - 1
- 2 each Inner Nylon Rudder & Elevator Pushrod Tubes - 1/8" Dia. x 25-3/4"
- 1 each Inner Nylon Throttle Pushrod Tube - 1/8" Dia. x 16"

## HARDWARE:

- ❑ 4 each #2 x 6mm (1/4") Phillips/Washer Head Screws - Aileron Mounting Block Attachment
- ❑ 8 each #2 x 8mm (5/16") Phillips/Washer Head Screws - Aileron Hatch Mounting
- ❑ 8 each M2 x 20mm (3/4") Phillips Head Bolts - Control Horn Mounting, 2 Per Horn
- ❑ 2 each M4 x 40mm (1-9/16") Phillips/Washer Head Axle Bolts - Main Wheel Axles
- ❑ 4 each M4 Lock Nuts - Wheel/Wheel Pant Attachment
- ❑ 4 each M4 x 20mm (3/4") Phillips/Washer Head Bolts - Main Landing Gear Attachment
- ❑ 4 each M4 Split Ring Washers - Main Landing Gear Attachment
- ❑ 4 each M3 x 10mm (3/8") Phillips Head Bolts - Wheel Pant Attachment
- ❑ 4 each M3 Split Ring Washers - Wheel Pant Attachment
- ❑ 8 each Threaded Metal Control Links - Throttle - 2, Rudder - 2, Elevator - 2, Ailerons - 2
- ❑ 6 each M2 x 22mm (7/8") Threaded Studs For Clevises
- ❑ 1 each Hardened Aluminum Blade Wing Joiner - 3mm (1/8") x 21/32" x 12-1/16"
- ❑ 1 each Rear Wing Locating Pin, Steel - 3/16" dia. x 2-3/8"
- ❑ 2 each Aileron Pushrods, Threaded One-End With "Z-Bends" - .070" x 3-1/8"
- ❑ 1 each 10" Metal Pushrod, Threaded One-End (4-Stroke Throttle Linkage Only)
- ❑ 1 each Solder Link (4-Stroke Throttle Linkage Only)

## MISCELLANEOUS:

- ❑ 4 each Hardwood Aileron Servo Mounting Blocks, 5/16" x 1/2" x 7/8"
- ❑ 1 each Fuel Tank Retainer - 5/16" x 3/4" x 3-3/16" Balsa
- ❑ 1 each Assembly Manual
- ❑ 1 each Decal Set, 6-3/4" x 20"

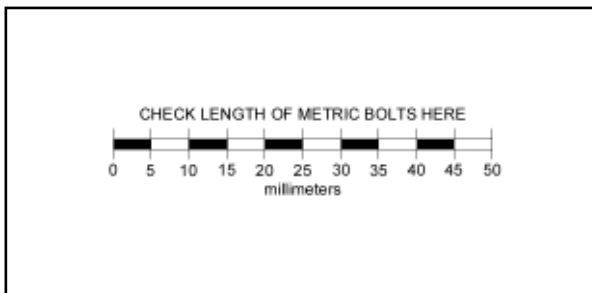

## WINGS:

The wings have designed and made to be a 2-piece system, joined by the main aluminum blade joiner at the spar box location and a steel locating pin at the rear. This system has proven to be very tough and easy to use. An obvious benefit is the fact that the wing panels can be easily transported or stored, requiring a minimum of space. Also, you might want to consider using 5-minute epoxy to permanently install the aluminum blade wing joiner and the rear steel locating pin into one of the wing panels. Doing this prevents accidentally losing these parts - your call. Note that the ailerons have been factory-hinged. Flex them up and down a few times to loosen them up and they are ready to use. Last, to avoid unnecessary dents, dings, or scuffing of the various covered parts, we suggest that you cover your workbench with a protective blanket or foam sheet.

For the following steps you will need two standard aileron servos, two 24" servo extensions and a Dual Servo "Y" Harness for your particular radio system.

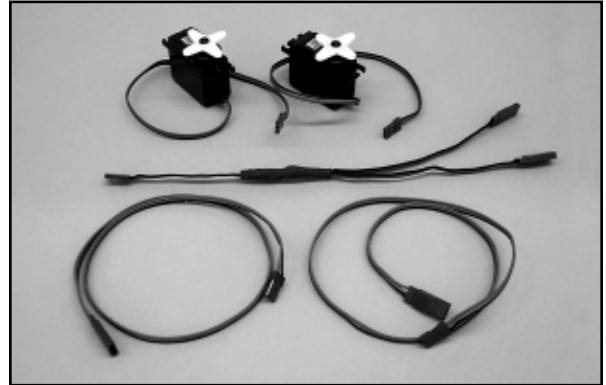

- ❑ 1) The aileron servo bay for each wing panel is located on the bottom surface, just in front of the aileron. These bays have been covered over and now need to be opened to allow access. Use a hobby knife to make four diagonal cuts from each corner of the servo bay, meeting in the middle.



Use a covering iron to seal the four loose edges of each side of the servo bay opening and trim the excess covering material with a hobby knife. Inside the servo bay opening you will find a short length of wood with a string tied to it. This string is used to pull the aileron servo lead through the wing and out of the opening in the bottom of each wing panel - leave it in place for now.

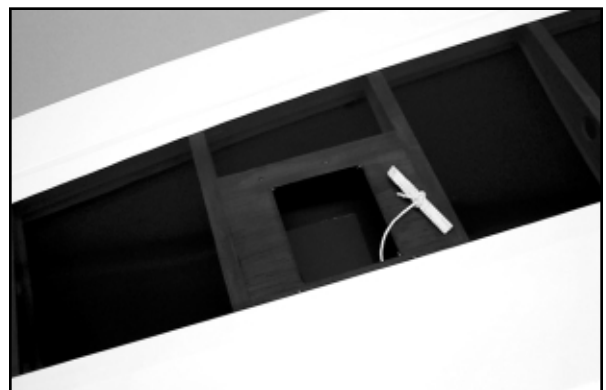

Also, on the bottom of each wing panel, at the center front location, you will see an oblong opening. This is the servo lead exit opening. Inside this opening you will see a piece of wood with a string tied to it - this is the other end of the string in the aileron servo bay. Leave the string in place for now.

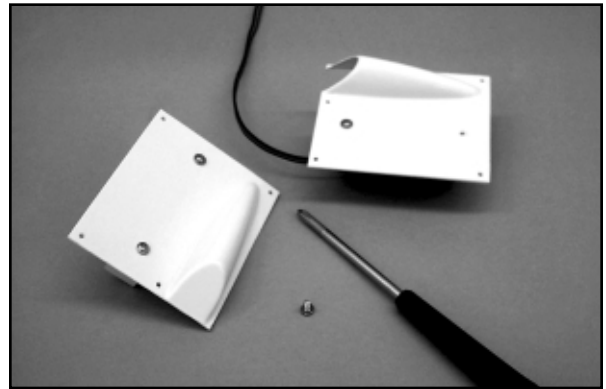
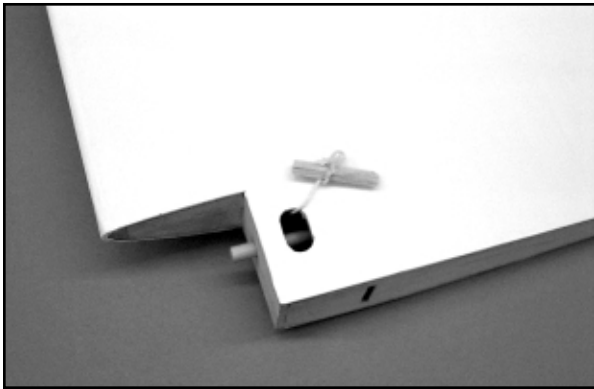

□ 2) The aileron servos are now mounted to the molded plastic servo hatch covers. Begin by installing the rubber grommets and brass eyelets, (supplied with your radio system), into each servo. Use epoxy to mount the hardwood blocks to the inside surface of the hatch cover, using the servo for spacing. Be sure to locate the servo with the output arm directly over the center of the molded aileron pushrod fairing as shown. Allow the epoxy to cure.

□ 4) Plug a 24" servo extension lead into each servo plug and secure the connection with plastic tape. Reach into the aileron servo bay and pull the small piece of wood with the attached string out of the opening. Remove the wood piece and securely tie the end of the string onto the end of the servo lead extension. From the inboard oblong opening near the center section of the wing panel, reach in and remove the piece of wood with the string tied to it - tweezers or needle nose pliers are handy for this. Lightly pull on the string to route the servo lead cable through the wing and out through the oblong center section opening. Pull the servo lead fully out of the exit hole, leaving no slack in the aileron servo bay.

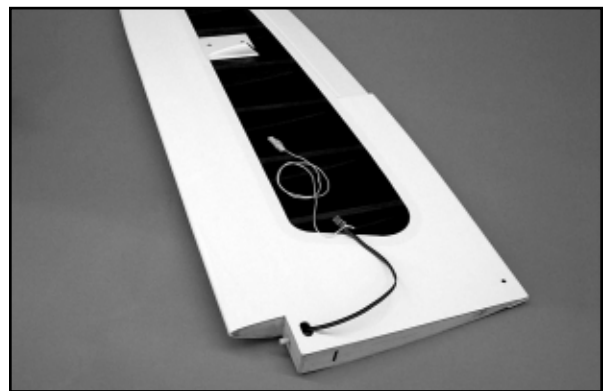
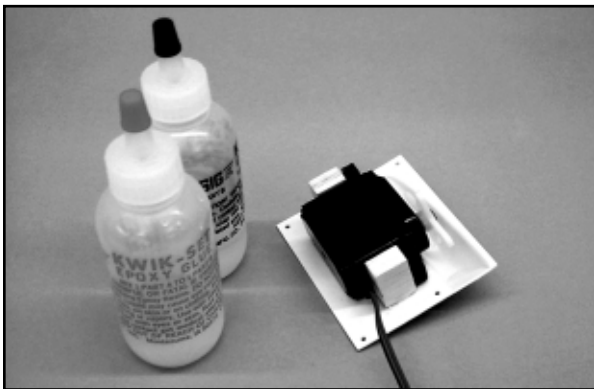

With the mounting blocks now positioned and glued in place, remove the servo. Use a Dremel® Tool and a tapered sanding drum bit to open the ends of the plastic aileron pushrod fairings where the pushrod passes through from the servo arm to the aileron horn.

□ 5) Carefully fit the plastic aileron servo tray, with the servo mounted, into the aileron servo bay. Since it is easily viewed through the top of the wing, align the servo accurately within the wing. Use pieces of masking tape to hold the servo tray in final position. Using the pre-drilled mounting holes in the servo tray as a guide, drill four 1/32" dia. guide holes through the sheeting in the bottom of the wing. Mount the servo tray using the provided #2 x 5/16" Phillips/Washer Head self-tapping screws. Mount the remaining servo tray into the remaining wing panel in the same manner. Because the servo tray will have to be removed briefly in the next few steps, remove the screws and set them aside for now.

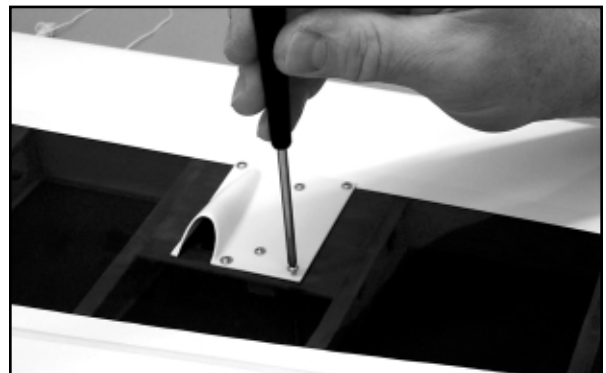
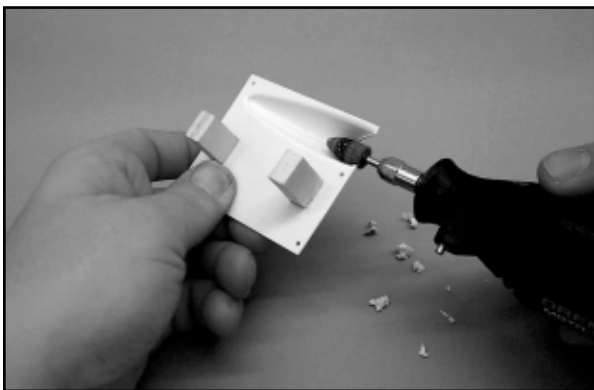

With the two servo trays now prepared, use the mounting screws provided with your radio system to secure the aileron servos to the mounting blocks. We suggest drilling small pilot holes first to avoid splitting the blocks.

□ 3) The final preparation step for the servo trays is to drill two 1/32" diameter holes in each servo tray, one directly beneath both hardwood servo mounting blocks, as shown. Use the four #2 x 6mm self-tapping screws provided to secure the mounting blocks.

- 6) From the kit contents locate two nylon control horns, four M2 x 3/4" Phillips Head bolts and two wire aileron pushrods (threaded at one end, "Z"-bend at the other end).

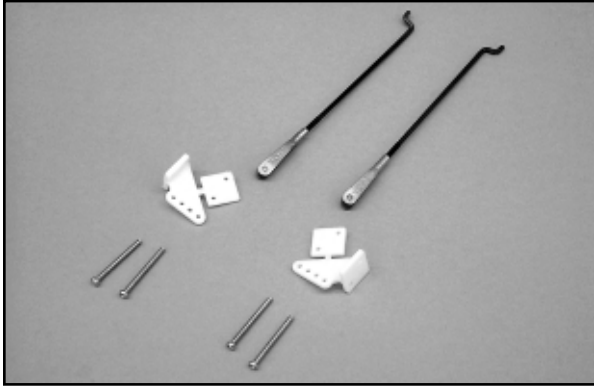

You will also need the aileron servo output arms that you intend to use. We like using the 4-arm type, choosing the arm with the longest length. You will likely have to use a small drill to open the holes in the servo arm in order to accept the .070" dia. pushrod wire. Slip the "Z"-bend end of the wire pushrod into the outer hole in the output arm and press the output arm onto the servo with the arm facing 90° down into the fairing molding on the servo tray, as shown (this is the ideal "neutral" position for the servo with the radio system on). Thread the metal control link onto the aileron pushrod about halfway, allowing an equal amount of adjustment in either direction.

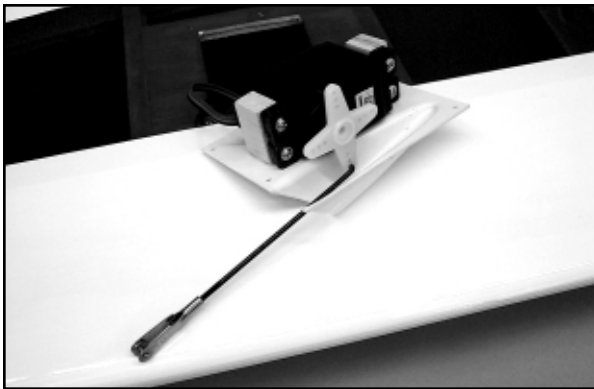

With the servos accessible, now is the time to check their movement and centering with your radio system. Connect the servo leads to the Y-harness and plug it into the correct aileron receptacle in your receiver. Connect the battery and turn the system on. First check for the correct direction of travel. Reverse the servo direction on your transmitter if necessary. Next, check the centering of the servo arms, with the trim lever in neutral. Remember that the output arm should be facing directly into the



molded fairing in the servo tray, at 90° to the servo. Take off and reposition the output arm as needed to achieve this. With these two issues addressed, install and tighten the servo output arm screws in both servos. Carefully re-install the servo and tray back into the aileron servo bay opening in the wing panel and secure it in place with four #2 x 5/16" Phillips/Washer Head screws. Use a couple of pieces of masking tape to hold the aileron in neutral.

- 7) Use a razor blade to remove the molded nylon mounting base from the back of the control horn. Attach the metal control link to one of the nylon control horns. With the wing panel upside down on the workbench, thread the control link on the pushrod as needed to position the base of the control horn at the leading edge of the aileron. Visually line-up the pushrod with the wing ribs, so that it is exiting straight out of the servo tray fairing. With these elements now in position, use a pencil to mark the two holes in the control horn base onto the aileron. Remove the control horn from the metal control link.



At one of the marks just made, drill a 3/32" dia. hole all the way through the aileron, perpendicular to the bottom surface. Slip a M2 x 3/4" bolt through the appropriate hole in the nylon control horn and push the bolt through the aileron. Position the horn and drill the remaining bolt hole, again perpendicular to the bottom surface of the aileron. Thread another M2 x 3/4" bolt through the nylon horn base and the aileron. Adjust the drilled holes as needed to line-up with the holes in the nylon mounting base. Align the holes in the base with the tips of the bolts protruding from the top of the aileron. With a small Phillips screwdriver, thread the bolts into the holes in the mounting base, securing the horn to the aileron - do not over-tighten the bolts. Repeat this procedure with the remaining wing panel. Use diagonal cutters to remove the exposed tips of the bolts on top of the nylon base and file them smooth. Connect the control links to the control horns.



**FUEL TANK ASSEMBLY:**

The 260cc (8.8oz.) fuel tank supplied with this kit is now

assembled. We suggest using a simple two-line fuel system in this airplane. One fuel line is connected to the fuel pick-up or “clunk” line and the engine’s carburetor. This same line is then used to fill the tank (if you are not using a fueling valve system). The second fuel line is the overflow line for use when filling the tank. After filling the tank this same fuel line is then connected to the engine’s muffler pressure nipple to provide manifold pressure to the tank. Note that the rubber stopper for the tank has two holes all the way through it. Use these two holes for the two aluminum fuel lines.

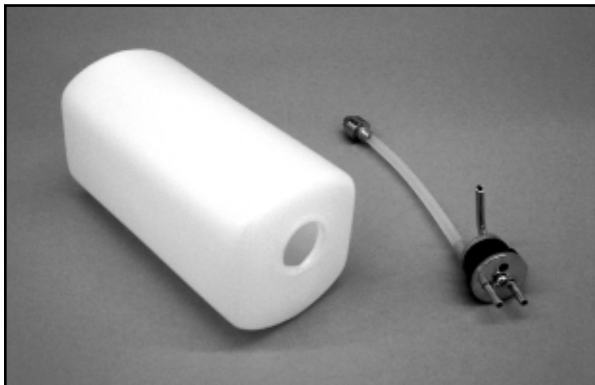

Gently bend the aluminum overflow tube upward to just reach (but not touch) the top of the tank. Adjust the length of the internal silicon fuel tubing to allow free movement of the fuel pick-up weight inside the tank. Insert the stopper assembly into the neck of the tank and secure it by tightening the compression bolt in the center of the stopper assembly. Slip short lengths of silicon fuel tubing over the aluminum fuel lines and identify each as “vent” and “carb” with small pieces of tape. This helps later when connecting the fuel lines to their proper locations. It is more convenient to install the fuel tank *after* engine installation.

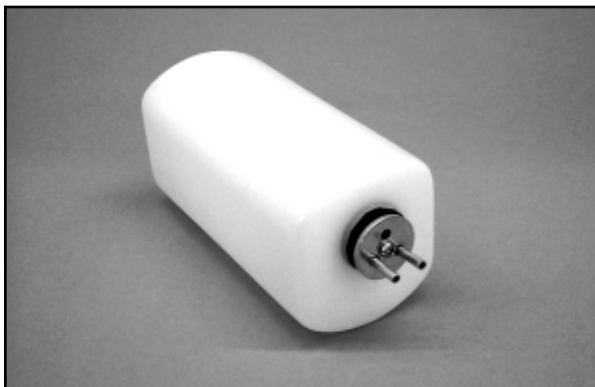

**OPTIONAL:**

Because of the inverted position of the engine in this design, we wanted to make the fueling and de-fueling process as simple as



possible. To do this we installed a Du-Bro #334 Kwik-Fill Fueling Valve onto the firewall in the engine compartment.

To mount the fueling valve, we made a simple 90° “L” bracket from a 3/4” wide strip of K & S .060 aluminum sheet. This bracket, with the valve in place, was then attached to the firewall using a couple of #2 x 3/8” socket head sheet metal screws.

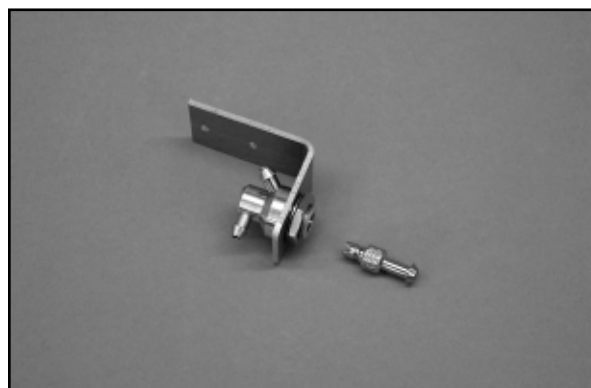

If you choose to mount the valve in the side position, as we did for our 2-stroke engine, then a smooth, round hole must be made in the side of the fuselage. This hole must be directly over the center of the fuel valve to allow the fuel probe to be inserted into the valve for filling and emptying the tank. Note that this valve can also be mounted with its face pointing straight down, as we did in the 4-Stroke Engine Installation. Mounted in this position, the need for a hole in the side of the fuselage is eliminated. The nice thing about this fueling system is its convenience, simplicity, and the fact that it only requires the two basic fuel lines to function. If you wish, a third fuel line can be used for fueling and de-fueling purposes. This dedicated third fuel fill line requires a second “clunk” fuel pick-up line inside the tank. The new Du-Bro #840 “Fill-It” product would be a good choice for this type of fuel tank set-up.

**ENGINE AND FUEL TANK INSTALLATION:**

This phase of assembly requires some custom installation work, based on the particular engine you’ve chosen for your Rascal Forty, (note that both right and down thrust adjustments are pre-built into this airplane). The following engine installation instructions have been separated into two general engine types - typical .40 - .46 2-strokes and typical .40 - .52 4-strokes.

The basic design of the RASCAL FORTY calls for mounting the engine inverted in the nose. Over the years there have been stories about inverted engines and how they run, primarily having to do with “flooding”. In our considerable experience with this airplane and with running engines mounted in the inverted position, we’ve found that both two and four-stroke engines work perfectly fine in the inverted position, with no more tendency to “flood” than engines mounted in other positions. Many, many model aircraft designs use engines mounted in the inverted position. The difference can generally be found in the starting procedures used by individual modelers.

Flooding is caused by an unwanted siphon effect from the fuel tank to the engine’s carburetor. Note that the position of the fuel tank in this design has taken this into consideration. However, siphoning can be minimized by remembering to keep the carburetor closed between flights. If you are using the Du-Bro #334 Fueling Valve, siphoning can be totally eliminated by inserting the filler probe into the valve between flights. Doing this closes the fuel line to the carburetor completely. When first starting the engine, keep the

throttle in the low position. Allow muffler manifold pressure from the tank vent line to get fuel to the carburetor. Avoid "choking" fuel through the line by placing your finger over the carburetor. With properly broken-in engines, these procedures should work perfectly every time.

## 2-STROKE ENGINES:

If you plan to use a 2-stroke engine, some basic openings in the nose of the fuselage must be made to allow for muffler clearance and mounting, as well as an exit hole for the needle valve. In addition, if you plan to use a fuel filler valve, such as the Du-Bro #334 Kwik-Fill Fueling Valve or some other type of fueling system, this will be the time to install it. For reference, the engine shown in the following assembly and installation steps is the Irvine .46, typical of engines in the .40 class.

The fuselage has the throttle pushrod housing tube already installed. However, this tube has not been glued in place and is removable. The firewall has been pre-drilled for installing the throttle tube on either side of the firewall. This allows for the different locations of various engine throttle arms, including 4-strokes. Before starting the engine installation, be sure the throttle pushrod tubing is on the correct side of the firewall for your particular engine. The remaining hole in the firewall can be filled with a short piece of rounded balsa, sanded smooth and fuel-proofed with thin CA, dope or epoxy resin.

□ 1) With the fuselage upside down on your workbench, temporarily install the two aluminum motor mount rails onto the left and right hardwood motor mount bearers in the nose of the fuselage. Align the oblong holes over the pre-drilled bolt holes and insert the four M3 x 20mm bolts with the large washers only (the lock washers will only be used when the engine is final-mounted) through the aluminum mount holes. Use a screwdriver to thread the bolts in place but do not tighten them. The aluminum rails should be just free enough to move.

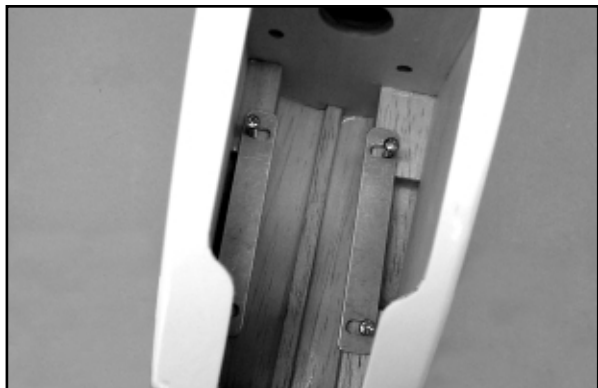

□ 2) With the muffler and needle valve removed, fit your engine in place between the aluminum rails, with its mounting lugs on top of the rails. Slide the engine into its approximate mounting position with the prop hub just ahead of the front of the fuselage by approximately 1/16" - 3/32". This spacing will be the clearance for the spinner backplate (temporarily mounting the spinner backplate to the engine and using 1/16" scrap balsa "spacers" makes this spacing easy and accurate). Be sure the aluminum motor mount rails are against the sides of the engine case and the engine is centered at the front. With the engine and aluminum mounts now in position, lightly tighten the four motor mount bolts to hold the aluminum rails in place. Remove the engine.



□ 3) Use alcohol or acetone to clean the bottom surfaces of the engine mounting lugs, removing any oil or grease. Do the same thing to the tops of the aluminum motor mounts, cleaning them completely. Apply 3 or 4 drops of thin CA glue to the bottom of each mounting lug on the engine. Carefully place the engine back into the nose of the airplane, positioning it with the proper 1/16" - 3/32" clearance for the spinner backplate. Hold the engine in place to the aluminum rails and use a little accelerator to set the CA glue.

□ 4) Loosen and remove the four bolts holding the aluminum rails in place and carefully remove the engine, with the attached aluminum rails, from the nose of the model.



□ 5) Use a shortened pencil with a sharp point to mark the locations of the engines mounting holes onto the aluminum motor mounts. To remember which rail fits on the right and left side of the engine, mark them with an "R" and "L" (left and right).

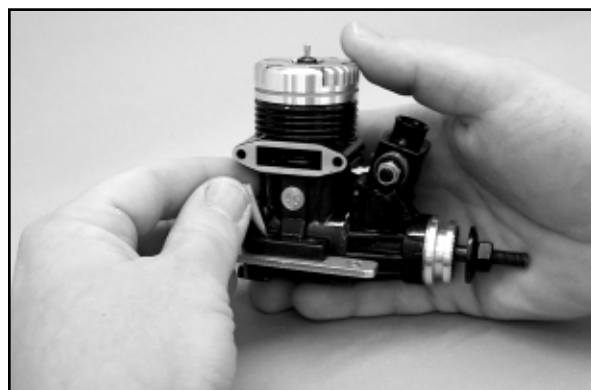

Tap the aluminum mounts to free them from the engine. Use the pencil marks to drill clearance holes through both motor mounts for the engine mounting bolts (not supplied). If you use typical 6-32 socket head bolts for mounting the engine, the holes should

be made with a 9/64" dia. drill bit.

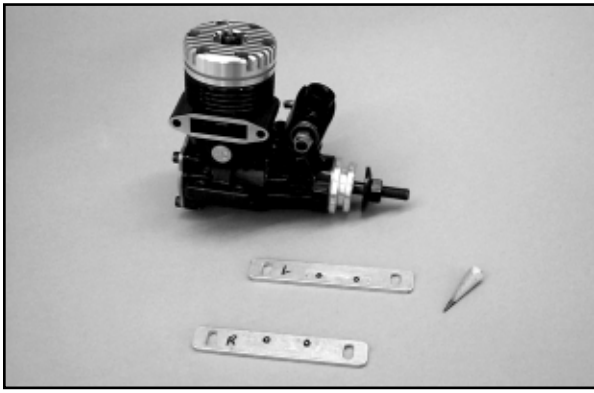

□ 6) Use the mounting hardware to now secure the engine in place to the aluminum rails. We used and recommend 6-32 lock nuts to secure the bolts. Note that in order to fit without interference, the threaded length of the mounting bolts must be trimmed to no longer than 9/16". Re-install the engine - mounted on the aluminum rails - back into the nose of the model and temporarily secure the rails with the four M3 x 20mm bolts.

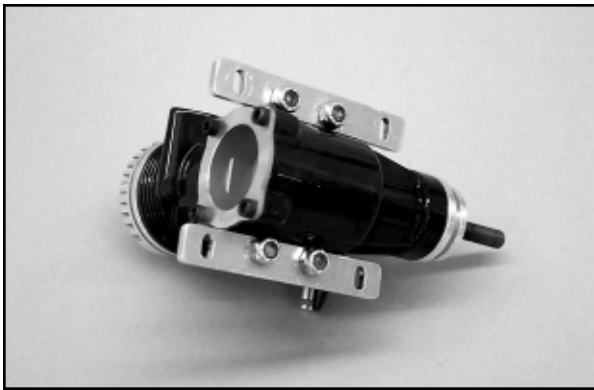

Basically, the engine is now correctly positioned and ready for final mounting. What remains is to accurately locate and open the required clearance holes for the engines' muffler, needle valve and any other needed openings, such as a clearance hole for the fuel filler valve, described earlier. To neatly create these openings, use a Dremel® Tool and various sanding and grinding bits, a drill with various bits, some sandpaper, a hobby knife and a sharp pencil or non-permanent marker pen.

□ 7) Use a pencil to mark the approximate location of the muffler manifold onto the *inside* surface of the engine compartment, where it will exit. Likewise, mark the approximate location of the engine's needle valve. Remove the engine and aluminum motor mounts. With the engine out of the way, use a straight pin and a



pair of pliers transfer the marks to the outside of the fuselage. Grip the pin tightly with the pliers, align the pin with the marks on the inside of the engine compartment and push it through the fuselage side and covering. This now shows you where to begin the holes. Use a Dremel® Tool and grinding bit to begin opening the muffler exit hole, a little at a time. Re-install the engine periodically to check the proper alignment of your work.

The final muffler opening should leave about 1/16" clearance around its outer surface. The edges of the opening should be sanded smooth. To make the needle valve exit, begin with a small drilled hole. With the engine in place, the hole should be opened progressively, centering it exactly with the carb. The diameter of the hole should be just a little larger than the diameter of the needle valve body. Note that with some engines, it may be necessary to make a music wire extension. Most engine manufacturers have holes and set-screws in their needle valve assemblies for this purpose.

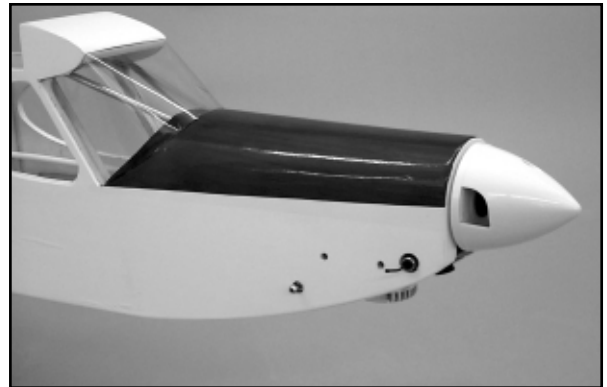

With the engine in place in the nose, mount the muffler and needle valve to check for final clearance and make any final adjustments that might be needed.



□ 8) If you are using the optional fueling valve, now is the time to

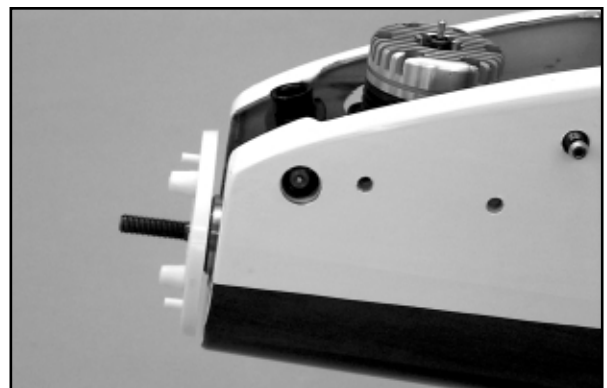



mount it and make the required hole in the side of the fuselage for the fueling probe. Locate the aluminum bracket to the firewall, (with the fuel valve in place), and mark the approximate location of the required opening in the fuselage side. Like the needle valve opening, start with a small drilled hole and open it up to match the center of the fueling valve.

□ 9) The engine compartment was fuel-proofed at the factory. However, the exposed wood edges of the muffler and needle valve openings should now be coated to make them fuel proof as well. We suggest using clear dope or epoxy resin to seal the exposed wood. To make the job look totally complete and custom, try using flat white or flat black dope or other fuel-proof paint.

□ 10) The fuel tank can now be installed. Apply a bead of silicon sealer around the neck of the tank and install it into the fuel tank compartment, through the top of the fuselage. Press the neck into the hole in the firewall. Included in the kit contents is a balsa piece measuring 5/16" x 3/4" x 3-3/16". This is used to hold the fuel tank in place at the rear. Position the balsa retainer directly behind the tank, between the fuselage sides. Apply a couple of drops of thin CA glue to each side of the balsa piece to hold it in place. If for any reason you need to remove the tank, the balsa piece can be easily popped loose and tank removed.



□ 11) Apply a little thread-locking compound to the threads of the M3 x 20mm mounting bolts. Install the lock washers onto each bolt, followed by the larger flat washers. Install the engine and aluminum rails into the engine compartment. Slip the four bolts (with washers) into the oblong holes in the aluminum rails. Thread the bolts into their blind mounting nuts and tighten the bolts firmly to the wood motor mounts - be sure to maintain the 1/16" - 3/32" spinner backplate clearance. Use medium fuel tubing (not supplied) to now make the required connections between the engine and fuel tank and the vent line and muffler manifold pressure nipple.

The throttle linkage will be made during the radio installation phase of these instructions. This completes the engine and fuel tank installation.

#### 4-STROKE ENGINES:

Installing the typical .40 - .52 4-stroke engine is similar to installing 2-stroke engines. However, there are obvious physical differences in the basic configurations of these engines, including totally different carburetor, throttle arm, and muffler locations. For reference, the engine shown in the following steps is a Magnum® XLFS .52AR 4-stroke, (to more easily install this particular engine, we reversed the carburetor position 180° on the intake manifold). The engine compartment in the Rascal Forty will accept virtually any make of 4-stroke engines in .40 to .52 c.i. sizes.



As mentioned in the 2-stroke instructions, the fuselage comes with the throttle pushrod housing tube installed, but not yet glued in place. The firewall has already been pre-drilled to allow installing this tube on either side. Before starting the engine installation, be sure the throttle pushrod tubing is on the correct side of the firewall for your particular engine. The unused hole can be filled with a short piece of dowel and sanded smooth. It should then be fuel-proofed with thin CA, dope or epoxy resin.

□ 1) Place the fuselage upside down on your workbench and temporarily install the two aluminum motor mount rails onto the hardwood motor mount bearers built-in to the nose of the fuselage. Align the oblong holes in the aluminum rails over the pre-drilled holes in the wood bearers and insert the four M3 x 20mm bolts with the larger washers only (the lock washers will only be used when the engine is final-mounted) through the aluminum mount holes. Use a screwdriver to thread the bolts in place but do not tighten them. Leave the aluminum rails just free enough to move.



□ 2) Remove the muffler header pipe and needle valve from the engine. Fit the engine in place onto the aluminum rails. Slide the engine to its approximate mounting position with the prop hub just ahead of the front of the fuselage by approximately 1/16" - 3/32". This spacing will be the clearance for the spinner backplate

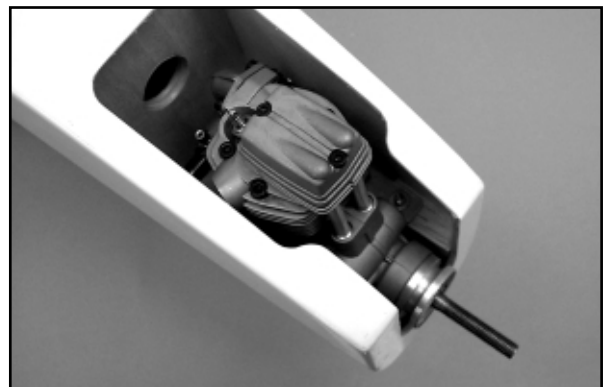

(temporarily mounting the spinner backplate to the engine and using 1/16" scrap balsa "spacers" makes this accurate). Slide the aluminum motor mount rails against each side of the engine case, making sure the engine is centered at the front. With the engine and aluminum mounts in this position, lightly tighten the four motor mount bolts to hold the aluminum rails in place. Remove the engine.

□ 3) Use alcohol or acetone to clean the bottom surfaces of the engine mounting lugs, removing any oil or grease. Do the same thing to the tops of the aluminum motor mount rails, (still bolted in place in the nose). Apply 3 or 4 small drops of thin CA glue to the bottom of each mounting lug on the engine. Carefully place the engine back into the nose of the airplane, positioning it with the proper 1/16" - 3/32" clearance for the spinner backplate. Hold the engine in place to the aluminum rails and use a little accelerator to set the CA glue.

□ 4) Loosen and remove the four bolts holding the aluminum rails in place and carefully remove the engine and aluminum rails from the nose of the model.

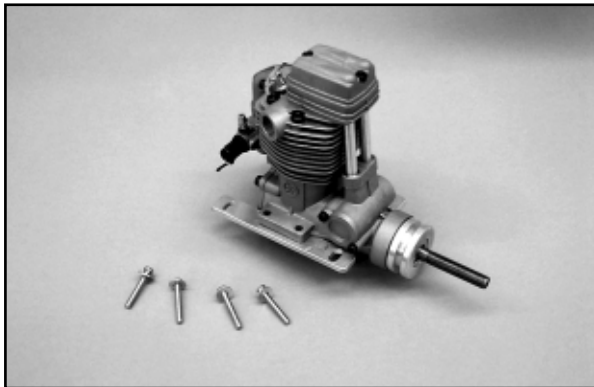

□ 5) Use a shortened pencil with a sharp point to mark the locations of the engines mounting holes onto the aluminum motor mounts. Tap the aluminum mounting rails to remove them from the engine. Use the pencil marks to drill clearance holes through both motor mounts for the engine mounting bolts (not supplied). When using typical 6-32 socket head bolts for mounting the engine, these holes should be made with a 9/64" dia. drill bit.

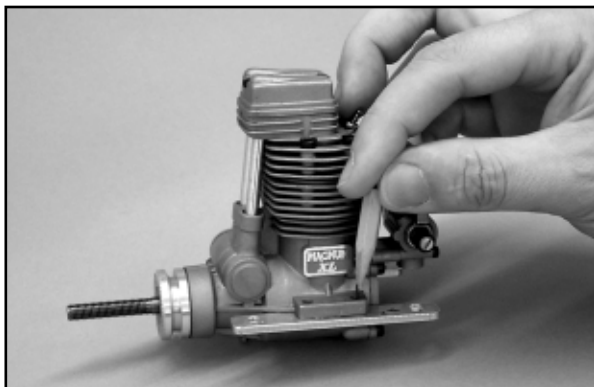

□ 6) Use your mounting hardware to now secure the engine in place to the aluminum rails. We used and recommend 6-32 socket head bolts and lock nuts for this purpose. Note that in order to fit without interference, the threaded length of the mounting bolts must be trimmed to no longer than 9/16". Re-install the engine - mounted on the aluminum rails - back into the nose of the model and temporarily secure the rails with the four M3 x 20mm bolts.

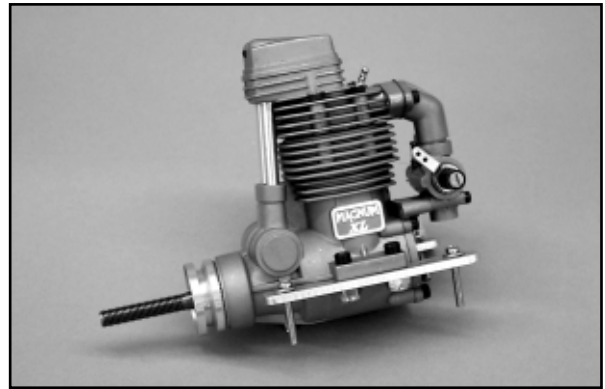

The engine is now basically in place, ready for final mounting. What remains is to accurately locate and open the required clearance holes for the engine's manifold/muffer pipe, needle valve and any other required openings for your particular engine.

□ 7) Use a non-permanent marker pen to mark the approximate position of the muffer manifold pipe onto the bottom surface of the fuselage, where it will exit. Likewise, use a pencil to mark the approximately centered location of the engines' needle valve onto the *inside* surface of the engine compartment. Remove the engine and aluminum motor mounts.

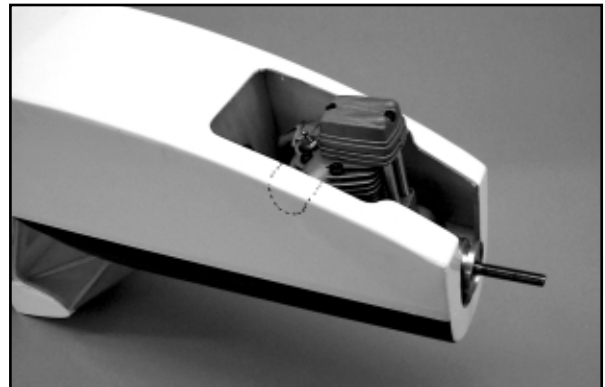

Use a Dremel® Tool and drum sanding bit to open a small, half-round opening in the side of the fuselage to allow clearance for the engine's manifold pipe. Leave about 3/32" clearance around the surface of the pipe. Sand the edges of this opening smooth.

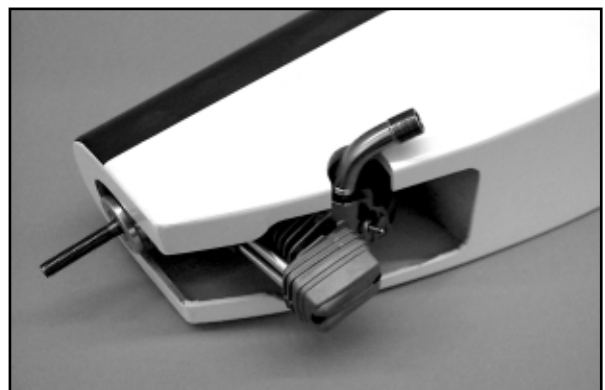

To make the needle valve exit hole, begin by using a pair of pliers and a sharp pin. Grip the pin tightly with the pliers and push the pin through the fuselage, at the needle valve mark made earlier. This discloses the location of the mark on the *outside* of the fuselage. Drill a 1/8" dia. hole through the pin hole. Put the engine in back in place and check the position of the hole with the needle valve opening in the carburetor. Adjust the hole to center it exactly

and progressively enlarge it to accept the needle valve body through the fuselage and into the carburetor. The finished hole should be just a little larger than the diameter of the needle valve body.



With the engine in place in the nose, install the manifold pipe and the muffler to check for the final fit. Install the needle valve into the carburetor. Make any final adjustments to these openings. You will likely need to add a wire needle valve extension to clear the fuselage side. The needle valve will have a hole in its center with a setscrew for this purpose. Use the engine manufacturer's included needle valve extension wire (the Magnum .52 did not include one) or make one from 1/16" dia. music wire.

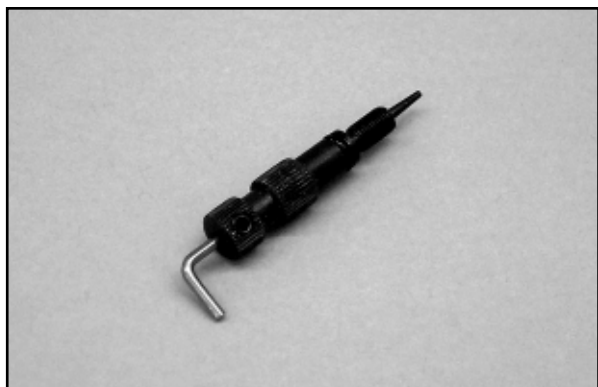

□ 8) If you are using the optional fueling valve, now is the time to mount it. We mounted ours on the left side of the firewall (opposite the throttle linkage), facing straight down. This works very well and eliminates the need for another hole in the side of the fuselage for the fueling probe. Make and install the aluminum mounting bracket to the firewall (with the fuel valve in place) and mark the location of the required #2 x 3/8 mounting screws onto the firewall. Mount the bracket to the firewall.



□ 9) The engine compartment has already been fuel-proofed at

the factory. However, the exposed wood edges of the muffler and needle valve openings should now be coated to make them fuel proof as well. We suggest using clear dope or epoxy resin to seal the exposed wood. To make this job look totally complete and custom, try using flat white or flat black dope or other fuel-proof paint.



□ 10) The fuel tank is now installed. Apply a bead of silicon sealer around the neck of the tank and install it into the fuel tank compartment, through the top of the fuselage. Press the neck into the hole in the firewall. Included in the kit contents is a balsa piece measuring 5/16" x 3/4" x 3-3/16". This is the rear tank retainer. Position the retainer directly behind the tank, between the fuselage sides. Apply a couple of drops of thin CA glue to each side of the retainer to hold it in place. Should you ever need to remove tank, the retainer can be easily popped loose and the tank can be removed.



□ 11) Apply a little thread-locking compound to the threads of the 3.5 x 20mm mounting bolts. Install the lock washers onto each bolt, followed by the larger flat washers. Install the engine and aluminum rails into the engine compartment. Slip the four bolts (with washers) into the oblong holes in the aluminum rails. Thread the bolts into their blind mounting nuts and tighten the bolts firmly

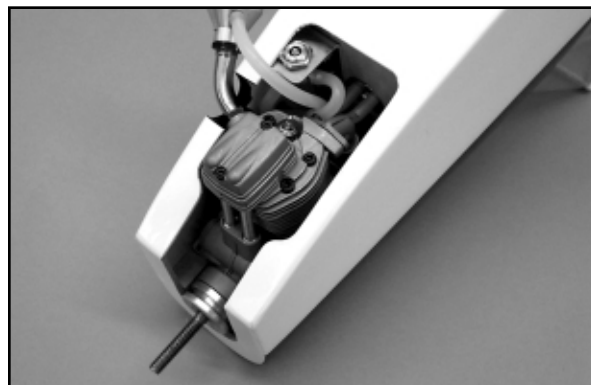

to the wood rail mounts - be sure to maintain the 1/16" - 3/32" spinner backplate clearance. Use medium fuel tubing (not supplied) to make the required connections between the engine and fuel tank and the vent line and the muffler manifold pressure nipple.

The throttle linkage will be made during the radio installation phase of these instructions. This completes the engine and fuel tank installation.

### SPINNER ASSEMBLY:

Locate the white SIG spinner assembly from the kit contents. This spinner is easy to install, lends a great look to your finished RASCAL FORTY ARF and is ready to use with typical APC propellers for engines in the size range for this model!

Start by choosing the correct adapter ring for your particular engine. The fit should be firm (*not* loose) over the engine's prop shaft. Slip the spinner backplate onto the prop shaft and onto the adapter ring. The propeller is installed next using the engine's washer and nut to secure it. The spinner cone is now installed over the prop and into the recess in the backplate. The spinner is then secured in place using the provided screws. Be sure to snug these screws firmly in place but do not over-tighten them.

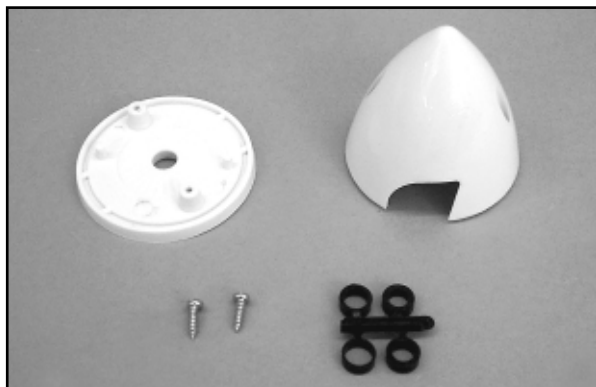

### FUSELAGE AND TAIL GROUP ASSEMBLY:

Note that the elevators have been pre-hinged to the horizontal stabilizer. Flex the elevators up and down a few times to free their movement. However, the rudder has not been pre-hinged and will have to be hinged during the following assembly steps.

□ 1) The fuselage has been built and covered with a few openings that now need to be opened up and cleared to complete assembly. These are the two landing gear bolt holes on the bottom of the fuselage and the three pre-drilled holes for mounting the tailwheel assembly, at the bottom rear of the fuselage.



Last, you will need to remove the covering over the rudder and elevator pushrod exits. These are located on each side of the fuselage, beneath the horizontal stabilizer. A sharp #11 blade is perfect for this step. If necessary, use a covering iron to re-seal the covering around these openings.



□ 2) From the kit contents, locate the horizontal stabilizer and elevator set and the vertical fin and rudder set. Join the wing panels together and bolt the wing to the fuselage. Set the airplane on a flat surface that allows you to easily view it from both the front and rear. Use 5-minute epoxy to glue the horizontal stabilizer/elevator assembly to the fuselage. Apply glue liberally to the stabilizer saddle at the top rear of the fuselage. Also apply glue to the bottom of the stabilizer where it contacts the fuselage. Carefully center the stabilizer to the fuselage, making sure it is centered in top view as well as in front and rear view. Use weights or pins to hold the stabilizer in this aligned position until the epoxy cures. Wipe off any excess glue with alcohol.

□ 3) Remove the rudder from the vertical fin, including the three hinges. The rudder will be hinged later. The vertical fin is now glued in place to the top of the stabilizer. Begin by trial-fitting the fin into the slot on the top of the stabilizer. Test the fit, making sure that the bottom of the fin sits flat and in full contact to the stabilizer. Trim or sand the bottom of the fin tab until the fin sits fully in place on top of the stabilizer. Holding the fin in place, use a sharp pencil to trace around its forward bottom fairing, where it extends forward of the stabilizer and on to the top of the fuselage. Remove the fin and use a sharp knife to remove the covering from just inside of the pencil marks just made.

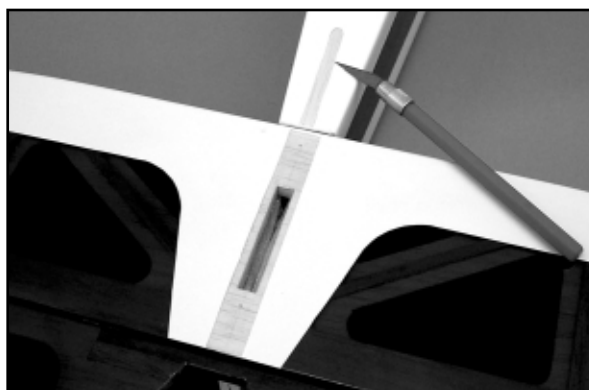

Use 5-minute epoxy to apply glue to the bottom of the vertical fin, including the tab that fits into the top of the stabilizer. Press the fin in place into the top of the stabilizer slot and wipe off any excess glue with alcohol. Use strips of tape and/or pins to align the fin at 90° to the stabilizer. View the airplane from the front, making sure the fin is perfectly upright and aligned to the stabilizer, wing, and fuselage without tilting one way or the other. With the fin now held

in position, allow the glue to set.

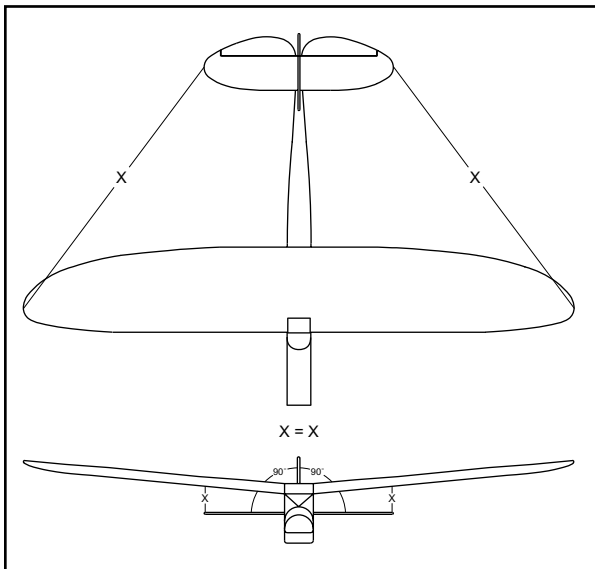

When the epoxy has set, remove the wing from the fuselage.

- 4) From the kit contents, locate the bag containing the pre-assembled SIG tailwheel assembly. Note that the bottom rear of the fuselage has a plywood hardpoint beneath the covering for mounting the tailwheel bracket.

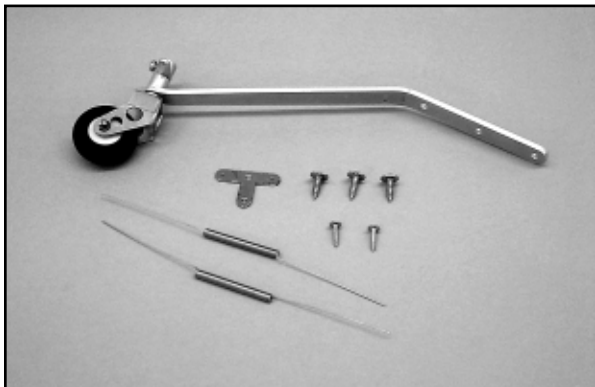

Mount the bracket to the bottom rear of the fuselage, using three #4 x 1/2" screws provided. Snug the screws securely.



- 5) Attach the aluminum spring centering horn to the bottom leading edge of the rudder, as shown, using two #2 x 3/8" screws. Note that the bottom leading edge of the rudder has hardwood beneath the covering as a hardpoint for the screws. Position the front edge of the horn 1/8" behind the leading edge of the rudder. Use the aluminum centering horn to first mark the required

locations for the screw holes and then use a 1/16" drill bit to make two guide holes into the bottom of the rudder. Secure the horn in place with the screws.

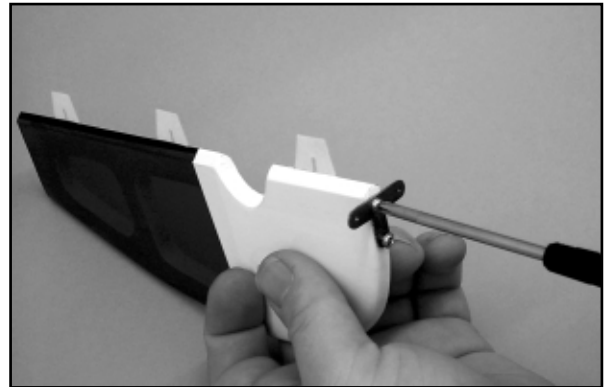

- 6) The rudder is now hinged to the vertical fin and fuselage. Slide the three CA hinges in place into the pre-slotted rudder, centering them. Use pins in the center of each hinge to keep them centered when pressing them into the hinge slots in the vertical fin.

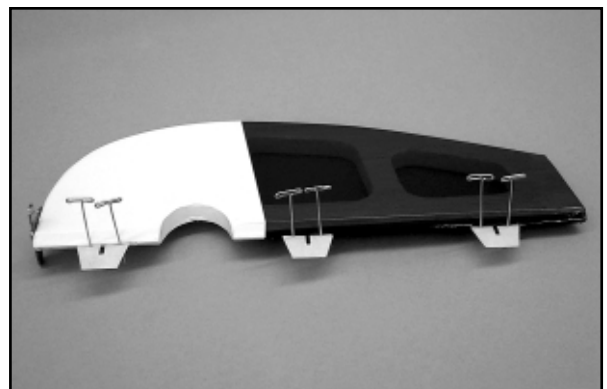

Press the rudder hinges in place into the hinge slots in the vertical fin. Adjust the rudder position to the fin and remove the pins. Use a piece of masking tape to hold the rudder hard over to one side or the other, exposing centers of the hinges. Use thin CA glue and apply 3 - 4 drops to each hinge. Remove the tape and use it to hold the rudder hard over to the opposite side and again apply 3 - 4 drops of CA glue to each hinge. Remove the tape, center the rudder by hand and allow at least 10 minutes for the CA glue to fully wick into and set each hinge. Flex the rudder back and forth to free its movement. The rudder is now hinged in place.

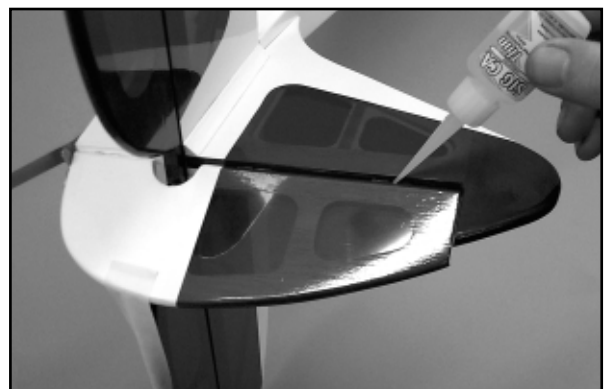

**NOTE:** The two tailwheel centering springs are not attached until after the rudder servo has been installed, tested and centered.

- 7) From the kit contents, locate the following parts: Formed

Aluminum Landing Gear, Fiberglass Wheel Pants, 2-3/4" Diameter Main Wheels and the following hardware:

- 2 each M4 x 40mm (1-9/16") Phillips/Washer Head Axle Bolts
- 4 each M4 Lock Nuts For Axle Bolts
- 2 each M4 x 20mm (3/4") Phillips/Washer Head Bolts - Landing Gear Attachment
- 2 each M4 Split Ring Washers - Landing Gear Attachment
- 4 each M3 x 10mm (3/8") Phillips/Washer Head Bolts - Wheel Pant Attachment
- 4 each M3 Split Ring Washers - Wheel Pant Attachment

We also suggest using thread-locking compound when assembling the wheel pants to the landing gear and the landing gear to the fuselage.

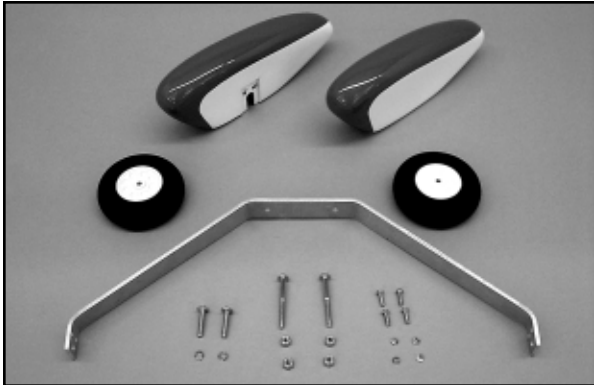

a.) Slip a M4 x 4mm axle bolt through the center of the wheel. Thread a M4 lock nut onto the threaded end of the axle bolt up to the hub, leaving just a little "play" to allow the wheel to rotate freely. Slip the threaded end of the axle bolt through the bottom hole in the aluminum landing gear and thread another M4 lock nut onto the axle threads. Tighten the lock nut up to the landing gear. Repeat the procedure with the remaining wheel. The wheels are now mounted to the landing gear and ready for the attachment of the wheel pants. (Note that we cut off the excess bolt material outside of the lock nut, using a carbide cut-off wheel.)



b.) Note that there is a front and rear edge to the aluminum landing gear. Facing toward the front of the airplane, the landing gear legs are canted slightly forward. Be sure to mount the landing gear and the self-aligning wheel pants in the correct direction!

Slip the wheel pant over the top of the wheel and slide it down in place over the wheel and onto the inner M4 lock nut. Doing this should line-up the holes in the aluminum landing gear with the holes in the wheel pant. If you encounter difficulty in sliding the pant into place, check the alignment of the inner lock nut and shift its position as needed to accept the slot in the pant. With the pant

in place, use two M3 x 10mm (3/8") bolts with M3 split ring washers to secure the pant to the landing gear leg. Check the wheel for free rotation. Repeat this procedure with the remaining wheel pant.

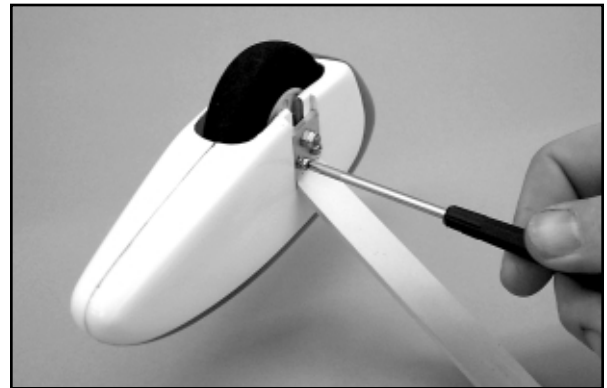

c.) The completed landing gear is now mounted to the fuselage using two M4 x 20mm bolts (3/4") and split ring washers. Be sure to use a little thread-locking compound on the threads and snug the bolts in place firmly.

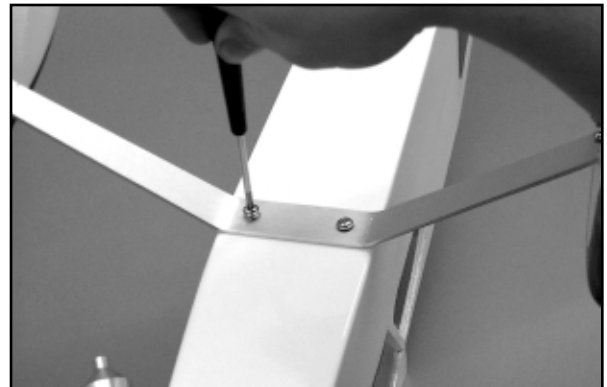

#### RADIO INSTALLATION:

Because the aileron servos are already installed and ready to use, the rest of the radio installation consists of simply mounting the elevator, rudder, and throttle servos in place and locating the receiver, battery pack and switch. The pushrod connections to the servos will be made shortly. Install the rubber grommets and eyelets supplied with your radio system onto each servo. Install each servo into its appropriate opening in the servo tray, routing the leads out from beneath the tray into the main cabin area. It can be handy to label the servo leads to identify them.

Looking down on the fuselage, as if you were seated in the cabin, with the servos behind you, the elevator servo fits in the right rear

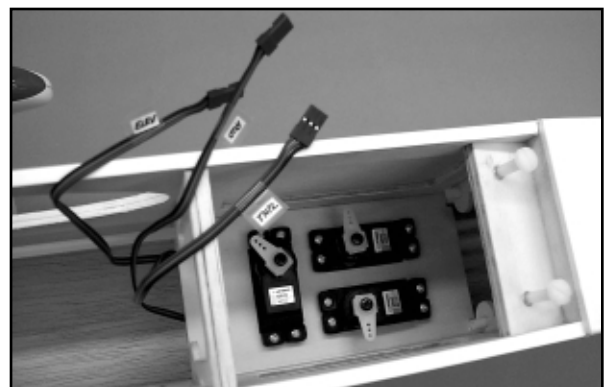

servo opening. The rudder servo fits into the left rear servo opening and the throttle servo fits into the forward opening. Position the throttle servo with its output arm on the correct side for connecting to the throttle pushrod. Use the mounting screws provided with your radio system to mount the servos in place to the servo tray.

The on/off switch can be mounted wherever it is most convenient - typically this is on the left side of the fuselage. If you want the switch in this location, you will need to cut a small rectangular slot for the switch in the fuselage side. Then, just mount the switch with the hardware supplied in your radio system. We prefer to mount our switches internally and in this design this is fairly easy to do. We placed the switch on the floor of the fuselage, just behind the main landing gear mounting block. We drilled the switch lever to accept a piece of .046 music wire. The wire simply extends out through the fuselage side with a simple "L" bend. Whatever switch mounting method you use, always make sure the switch is securely in place with no pressure on the wiring.

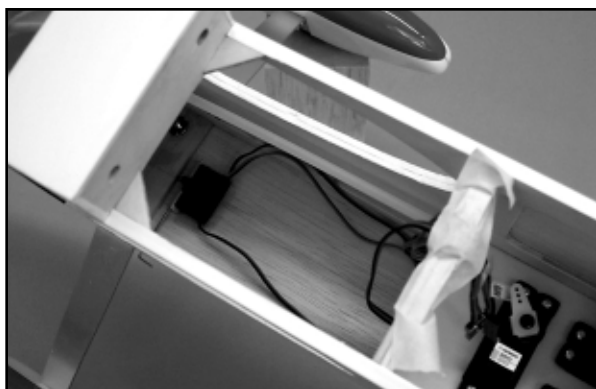

With the servos and switch in place, the receiver can now be placed into the fuselage. Connect the servo leads to the appropriate channel in the receiver. Also plug the "Y-harness" connector in place into the aileron channel and the switch connector into the receiver's battery receptacle. Wrap the receiver in protective foam, held in place with rubber bands, tape, etc. Install the protected receiver into the compartment directly beneath the servo tray. The "Y-harness" leads should both be left sticking out of this opening and accessible. Likewise, the receiver antenna should also be exiting this opening in the fuselage former. Gently press the receiver in place beneath the servos.

We have found that with this design, the easiest way to route the antenna out of the fuselage is to make a small hole, (about 1/16" or so), in the bottom fuselage sheeting, just ahead of the middle cabin former. To avoid pulling on the antenna at the receiver, fit the antenna wire with the radio manufacturer's supplied strain relief fitting. Route the antenna through the hole and back toward the

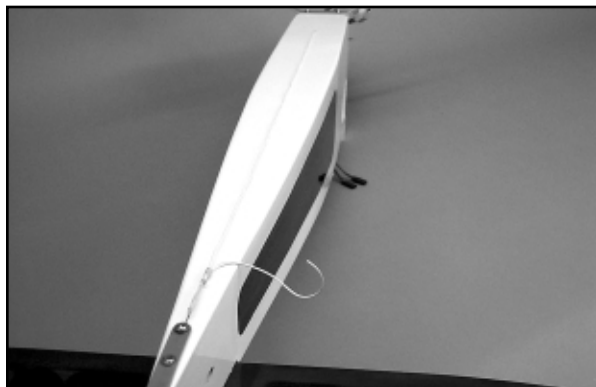

tailwheel bracket. We made a simple wire hook from a straight pin and attached it to the forward screw holding the bracket in place. We then used a rubber band to anchor the antenna along the bottom length of the fuselage.

For now, leave the battery pack loose. When you check for the correct Center of Gravity in the next few steps, the battery pack will be positioned as needed. At that time it can be wrapped in foam and placed in the fuselage.

Installation of the pushrods in the following steps requires the use of your radio system. Therefore you should now prepare the radio system for this purpose. First, make sure both the airborne and transmitter batteries are charged. Next, turn the system on and check the throttle, elevator, and rudder servos for the correct direction of travel. Using the transmitter, reverse any servo traveling in the wrong direction. Make sure that the trim levers for these servos are all in neutral. Last, prepare and mount the servo output arms onto each servo - *do not* install the locking screw at this time. As shown, we prefer using 4-arm output arms, using the longest arm for the linkage. We also typically cut-off the remaining, unused arms to avoid clutter. The rudder and elevator pushrod connections will be made on the outside of these two servos. Therefore, the servo output arms should be mounted on the servos with the link holes at 90° to the servo - this is going to be the "neutral" position for the rudder and elevators. The throttle servo arm is typically mounted at approximately 45°, allowing uniform travel in either direction (final adjustments to the throttle linkage will be made during set-up).

#### **PUSHROD INSTALLATION:**

The control pushrod system used in this design is very straightforward. The outer nylon control tube housings have already been installed in your model. What remains is to make the inner nylon pushrod connections from the servos to the rudder, elevators, and throttle. From the kit contents locate the following parts:

- 2 each M4 x 40mm (1-9/16") Phillips/Washer Head Axle Bolts
- 2 each Inner Nylon Control Tube - Rudder and Elevator Pushrods
- 1 each Inner Nylon Control Tube - Throttle Pushrod
- 6 each Threaded Metal Control Links
- 6 each M2 x 7/8" Threaded Control Link Studs
- 2 each Nylon Control Horns
- 4 each M2 x 3/4" Phillips Head Bolts - Control Horn Attachment

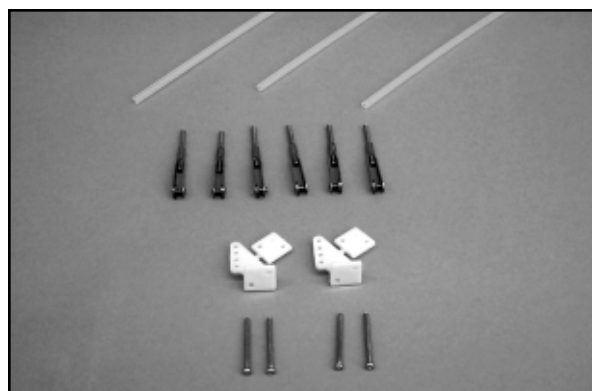

□ 1) Begin with the rudder pushrod. Install one of the 7/8" threaded studs into one end of a 25-3/4" inner nylon control tube. Thread the stud into the tube about 1/4". (A neat way to do this is to use an electric hand drill. Lightly chuck the stud into the drill and

thread it in place - simple!)

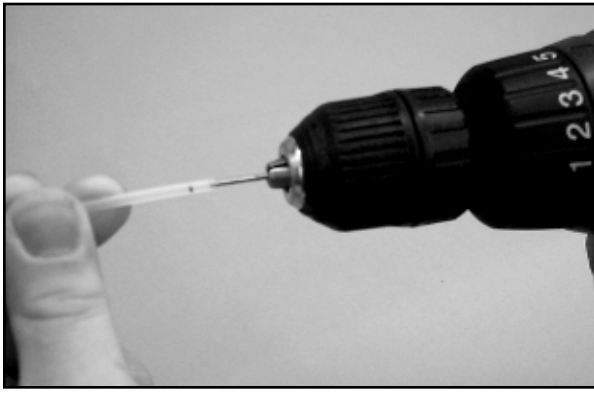

Slip the opposite end of the pushrod into the outer tube exit at the left rear of the fuselage and push it into the servo compartment. Thread a metal control link onto the stud, centering the threads to allow equal adjustment in either direction. Use a hobby knife to remove the screw base from one of the nylon control horn and snap the control link into the outboard hole in the horn. Use a piece of masking tape to position and hold the rudder in neutral to the vertical fin.

Hold the base of the control horn to the rudder, lining up the holes in the horn with the rudders hinge line. In this position, use a pencil to mark the two hole locations in the horn onto the surface of the rudder. Push the horn and pushrod out of the way and use a 3/32" dia. bit to drill two parallel mounting holes through the rudder. Mount the control horn to the rudder using two M2 x 3/4" bolts and the nylon screw base piece. The excess bolt material can be removed with diagonal cutters and filed smooth.



□ 2) Remove the pushrod tube from the fuselage. Re-insert the unprepared end of the pushrod into the fuselage from the servo compartment, with the stud and metal link at the rudder servo. Connect the metal link to the outer-most servo arm hole. Make sure the rudder servo is in "neutral" - turn the radio system on if necessary.

Thread another M2 x 7/8" stud into another metal link. Attach the link and stud to the rudder control horn. Line-up the stud with the pushrod and use a marker pen to mark the nylon pushrod where it will be cut to accept 1/4" of the exposed threads of the stud. Remove the metal link from the rudder horn and pull the pushrod back out of the fuselage from the servo compartment. Remove the stud from the metal link. Use the mark just made to cut the pushrod to final length.

Use an electric drill to thread the stud into the trimmed end of the

pushrod. Re-insert the pushrod into its tube housing from the servo compartment. Connect the metal link to the servo output arm and attach the arm to the servo in the neutral position. Thread the remaining metal link onto the exposed end of the stud at the rear of the fuselage. Thread the link as needed to line it up with the holes in the nylon control horn. Snap the metal link into the nylon horn (the outer hole is the one we used). Remove the tape holding the rudder in neutral to the vertical fin.

The rudder pushrod is now complete, perhaps needing only small final adjustments. At this point we suggest carefully applying a drop of thin CA glue to the metal control link and its threaded stud in the servo compartment. This secures the metal link to the stud, preventing unwanted trim changes due to the twisting of the pushrod. Small link adjustments can be made with the metal link at the rudder horn. **NOTE:** We use and highly recommend short lengths of medium silicon fuel tubing over the arms of the all the metal links, keeping them securely in place to the servo arms and nylon control horns. This safety measure should be done to all such connections on this, or any other aircraft.



□ 3) The two tailwheel centering springs are now attached to the tailwheel steering bracket (just above the tailwheel itself) and the aluminum spring centering horn mounted earlier to the bottom of the rudder. These springs are installed and bent to impart just a little tension on the tailwheel bracket. Install the two springs as shown, making sure the tailwheel is facing exactly forward when the rudder is in neutral.

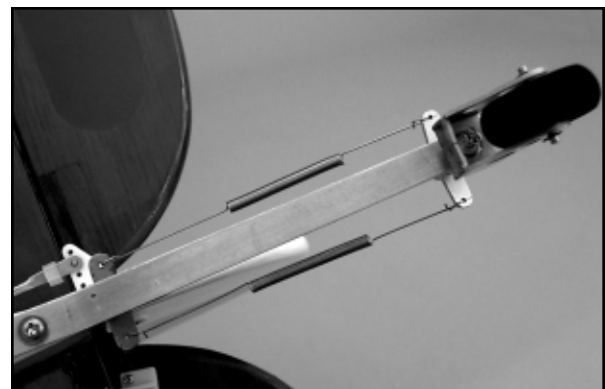

□ 4) The elevator pushrod is made in exactly the same way as the rudder pushrod. Be sure to tape the elevators in "neutral" at each side of the stabilizer before cutting the nylon pushrod to final length.

□ 5) As mentioned earlier, the throttle pushrods will be different for 4-stroke engines. This is due to the typical location of their carburetors and throttle arms. These steps will cover both 2 and 4-stroke throttle pushrods, beginning with 2-stroke set-ups.



## I. 2-STROKE THROTTLE PUSHRODS:

The throttle pushrod for typical 2-stroke engines is the traditional push-pull type, cut to length, with metal control links at each end.

a) From the kit contents, locate the 16" length of inner nylon pushrod tubing, two M2 x 7/8" threaded studs and two metal control links. Use an electric drill to thread one of the studs about 1/4" into one end of the nylon pushrod. Thread a metal control link onto the threaded stud and insert the unprepared end of the pushrod into the tube pushrod housing protruding from the firewall. Snap the metal control link onto the throttle arm of your engine.

b) Look at your engine to determine which direction the throttle arm must travel to be in the full throttle position - using the transmitter, set the direction of travel for the throttle servo accordingly.

c) Thread the remaining stud into the remaining metal control link. Snap the link onto the outermost hole in throttle servo output arm. Use a marker pen to mark the nylon pushrod where it should be cut and still accept about 1/4" of the threaded stud. Disconnect the metal link from the servo arm and remove the pushrod from the fuselage tube. Cut the tubing at the mark just made. Unthread the stud from the metal link and use the electric drill to thread the stud into the end of the pushrod, about 1/4".

d) Re-insert the pushrod into the fuselage from the firewall. Thread the metal link onto the stud in the servo compartment. Connect the front metal link to the throttle pushrod arm on the engine and turn on the radio system. Adjust the metal link in the servo compartment as needed to achieve full and low throttle settings with the transmitter. Note that in some cases, this may require moving the metal link on the servo output arm. As done with the elevator and rudder pushrods, apply a drop of thin CA glue to the threads on the stud and control link at the engine end of the pushrod to keep the pushrod from twisting. Last, apply a drop or two to the firewall where the throttle tube housing exits, to lock the outer tube in place.

## II. 4-STROKE THROTTLE PUSHRODS:

The throttle pushrod for 4-stroke engines is *almost* exactly the same as it is for 2-stroke engines. The difference has to do with the rear throttle arm location on most 4-stroke engines. Because of this, the pushing and pulling of the pushrod, from the rear, must be changed to get the same action from the front. To do this, it is necessary to make a pushrod - in the engine compartment - that reverses the action of the servo at the engine throttle arm. We do this by replacing the 7/8" threaded stud with a longer wire pushrod that's threaded at one end. Also, it is important that the engine throttle arm is facing upwards, toward the head of the engine. This throttle arm position allows it to be more easily accessed for attachment of the metal control link. Every engine we tested for this model allowed repositioning of the throttle arm.

a) From the kit contents, locate the 16" inner nylon pushrod, a M2 x 7/8" threaded stud, a metal control link, a 10" metal pushrod wire (threaded at one end) and a metal solder link (no internal threads). Use the electric drill to thread the 10" metal pushrod into one end of the nylon pushrod - about 1/4". You will also need a soldering iron and solder.

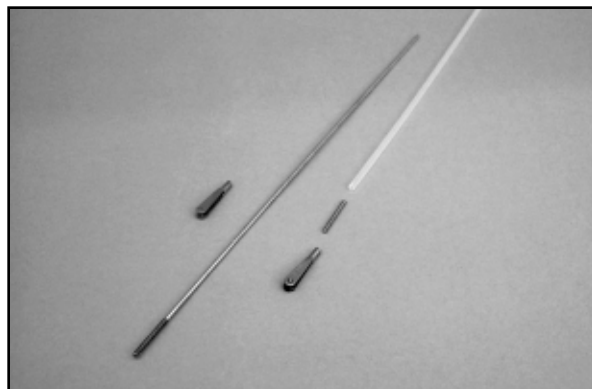

b) With the 10" pushrod threaded into the nylon pushrod, measure 3" from the front face of nylon pushrod, out onto the metal pushrod and mark the point with a marker pen. This is the point where you will begin to make a 180° bend in the metal pushrod wire. The diameter of this bend should be the same as the distance from the center of the pushrod exit in the firewall to the hole in the engines throttle arm. For example, this distance measured 1" on our Magnum .52. Therefore, we bent the pushrod 180°, leaving a 1" spacing.

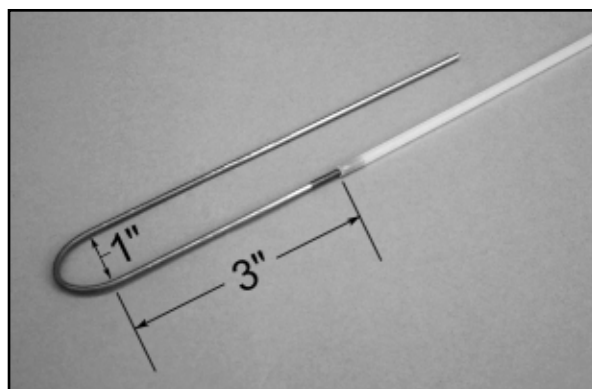

c) The end of the wire that reverses back toward the nylon tube is now cut, leaving just enough wire to slip the solder link in place. Cut the wire with a carbide cut-off wheel and slip the solder link in place. Solder the link in place to the wire with the arms of the link facing toward each side of the wire in top view. This position allows the two arms of the link to be spread and placed onto the throttle arm.

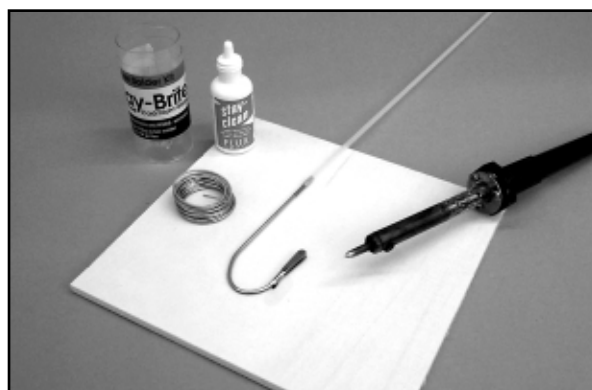

d) Insert the unprepared end of the nylon pushrod into the tube protruding from the firewall, all the way back to the servo compartment. Use needle nose pliers or hemostats to connect the solder link to the throttle arm on the engine. From the servo compartment, test the action of the pushrod and adjust the bend as needed to obtain a smooth throttle movement.

e) Thread the M2 x 7/8" stud into the remaining metal control link. Attach the link to the outermost hole in the throttle servo arm. Turn on the radio system. With the action of the throttle pushrod reversed, full "low" throttle is obtained by pulling the pushrod back in the servo compartment, as far as possible. Pull the pushrod back and place the servo output arm onto the servo in the correct full "low" throttle position. Mark the nylon pushrod with a marker pen where it will be cut and still accept about 1/4" of the threaded stud. Remove the nylon pushrod from the fuselage and cut it off at the mark just made.

f) Remove the M2 x 7/8" threaded stud from the metal link and use an electric drill to thread one end of it into the nylon pushrod, about 1/4". Re-insert the pushrod into the tube in the firewall, all the way back into the servo compartment. Thread the metal link back onto the end of the stud and attach the link to the servo output arm. Adjust the link as needed on the stud to fit perfectly with the "low" throttle position of the output arm. Test the throttle linkage with the radio system, making any adjustments needed for smooth action. Many radio systems available today, such as the Airtronics™ RD-6000 Sport system have an "EPA" or End Point Adjustment feature. This feature allows electronic adjustment of the total movement of any servo. EPA can be used to adjust the movement of the throttle servo as required.

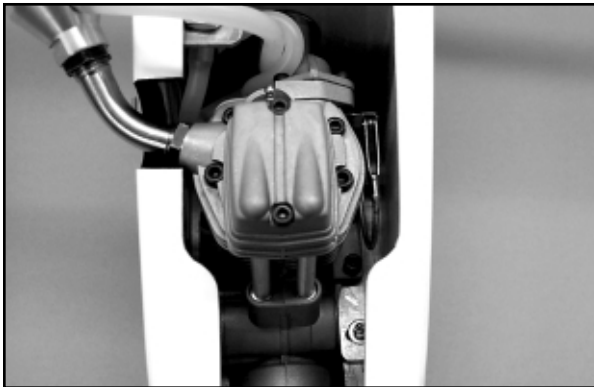

□ 6) The battery pack will be installed when the correct Center of Gravity is established. For now the radio installation is complete. Be sure to install and tighten the output retaining screws in each servo.

**CONTROL SURFACE TRAVEL:**

The following control surface movement suggestions will provide your RASCAL FORTY with smooth, predictable flight characteristics. We suggest that you start with these movements and adjust them later to suit your particular style of flying. Note that the rudder and elevator measurements are taken from the widest part of the surface at the trailing edge. The aileron measurements are taken at the inboard trailing edge.

- AILERONS:        3/4" UP – 3/4" DOWN**
- ELEVATORS:     3/4" UP - 3/4" DOWN**
- RUDDER:         1" LEFT - 1" RIGHT**

**SIDE WINDOW INSTALLATION:**

From the kit contents, locate the small bag containing the molded clear plastic side windows. The side windows are molded to mount and fit into the fuselage window frames, from the inside. Use scissors to cut out each window, leaving about 1/8" of plastic around the edges for a gluing surface.

We suggest using 5-minute epoxy or RC-56 glue to mount these windows. **Do not** use thin CA glue for this purpose! Apply a thin bead of glue around the edges of the plastic window and press it in place from the inside of the fuselage. Use a few small pieces of tape to hold the window in place until the glue sets. A little alcohol will safely clean off any excess glue from the windows.

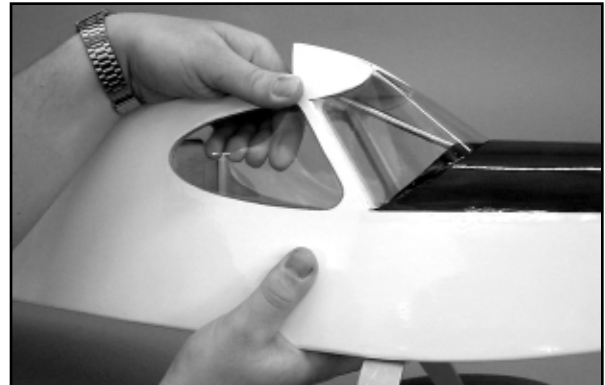

**DECAL APPLICATION:**

The decals supplied with your RASCAL FORTY ARF kit are high quality Mylar® with an extremely aggressive adhesive. These are not die-cut decals and must be removed from the sheet with a hobby knife and a sharp #11 blade or sharp scissors. In the case of the large doorframe outline, we suggest that you cut this decal out on both sides of the frame outline, in one piece. If you are careful, this isn't as difficult as it sounds. Application of this decal is easy if you follow the methods described below.



We suggest the following method to accurately apply the larger decals in this kit. Carefully cut out the decal and lift it off the sheet with tweezers. Use a product like SIG Pure Magic Model Airplane Cleaner, Fantastic®, or Windex® to spray the area of the model that will receive the decal. Then spray the adhesive side of the decal as well. Lightly position the decal in place on the model. The liquid

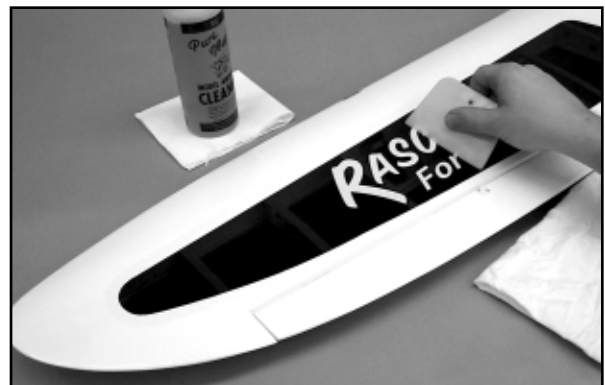

cleaner allows the decal to slide easily into the desired position as long as you don't press down on it. Once you have it in position, hold the decal lightly in place with your fingertips and use a paper towel to gently dab the excess liquid away. Use a small squeegee to now set the decal in place, removing all excess liquid and any trapped air bubbles from beneath the decal. The SIG 4" Epoxy Spreader - #SIGSH678 - is perfect for this job. Remove any excess fluid with a dry paper towel and allow the decals to set overnight. They will be solidly adhered to the model without any air bubbles.

### **CENTER OF GRAVITY:**

Establishing the correct Center of Gravity on this or any R/C model airplane is critical to its ultimate success in the air. The recommended starting balance point for the Rascal Forty ARF, is located 3-3/8" behind the leading edge of the wing, immediately next to the fuselage side. This is the location of the main wing spar. We have flown this airplane with the C.G. location back as far as 3-7/8" without any trouble. However, moving the C.G. further back tends to make the elevators more sensitive. Remember that the C.G. location is always determined with the fuel tank empty.

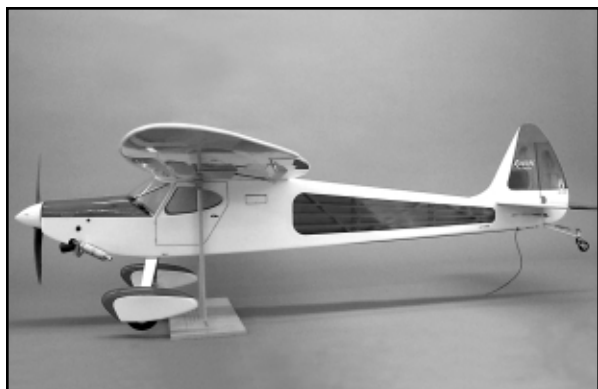

Using a simple balancing fixture, such as two dowels with rubber tips to protect the finish, is the most accurate method for determining and adjusting the correct C.G. location. However, since the balance point is located at the main wing spar on this airplane, yourself and a friend can lift the assembled model at the wingtips to check the balance. The airplane should balance perfectly level. If the nose hangs down, the model is nose heavy. Likewise, if the model hangs tail down from level, it is tail heavy. If either of these conditions exist, they should be corrected.



If the model is nose heavy, try shifting the location of the battery pack a little further back to correct the condition. If the model is still nose heavy, small stick-on lead weights - available from your hobby shop - can be used to temporarily correct the problem. Later, these can be placed inside the fuselage, through a hole that

can then be covered over with matching covering film.

If the model is tail heavy, move the battery pack as far forward as possible to correct the problem. If the airplane still needs more weight to balance, several things can be done:

- Heavier, after-market wheels
- Heavier, after-market metal spinner
- A larger, thus heavier, battery pack
- A brass Heavy Hub propeller nut - available from Harry Higley Products

In the unlikely event that you cannot achieve the correct Center of Gravity using the above methods, then stick-on lead weights should be used.

### **FLYING:**

If you have carefully followed the assembly instructions in this manual, test flying your new RASCAL FORTY ARF should be a lot of fun. When it comes to test flying a new model, we always advise modelers to choose a calm day with little or no wind. These conditions allow you to better evaluate and more accurately adjust the trim requirements for your airplane. As we've mentioned before, a good running, reliable engine is a must for the ultimate success of your airplane. Take the time to solve any engine problems *before* you try to fly.

Always make it part of your pre-flight routine to check each control on the airplane, making sure the surfaces are moving in the correct directions. Also check each control linkage to be sure they are secure and that nothing is loose. With all the controls checked, make a range check with your radio system, making sure everything is working perfectly.

After starting and warming up the engine, taxi the RASCAL out to the take-off position on the flying field, (holding up elevator during the taxi will keep the tailwheel firmly to the ground). For take-off, the airplane should be lined-up with the center of the field with the nose pointed directly into the wind. Hold a little up elevator and smoothly advance the throttle - *do not* slam the throttle full open all at once. As the RASCAL begins moving forward, back off of the up elevator input and use the rudder, only as needed, to correct any engine torque and/or wind induced deviations from a straight take-off run. Allow the airplane to lift off, using ailerons to keep the wings level. Climb to a reasonable altitude before making any trim changes.

Although not intended as a trainer, the RASCAL FORTY ARF is a very forgiving design that allows you to fly at relatively low speeds, giving plenty of time to learn the basics of R/C flight. With the control movements set at the measurements provided in this manual, the airplane should exhibit smooth, predictable control. Try a few loops and rolls. You will find that the roll rate is not especially high at the initial aileron settings but they can be very axial with practice. Inverted flight is easy, requiring surprisingly little down elevator for level flight. The RASCAL also performs nice inside and outside loops, snap rolls, Immelmans, stall turns, Cuban eights, spins, and even a respectable avalanche. Of course, it is not a pattern aircraft but with practice, there isn't much that it won't do. As with any aircraft, getting consistently good results is usually just a matter of practice. In all of this, we'll bet one of your favorite maneuvers will be those long, low fly-bys - what a great looking airplane!

While still at altitude, throttle the engine back to idle. This will give

you a good idea of the glide characteristics. While still at idle, steadily increase up elevator input to get a feel for the stall characteristics. With practice and a little rudder input, the RASCAL FORTY ARF can be flown to a virtual standstill before stalling. Stalls tend to be very gentle with one wingtip or the other dropping, followed almost immediately with resumed flight. This is great information to have when setting up your first landings.

You will find that this airplane has a powerful rudder. As you gain experience and confidence with the RASCAL FORTY, you will find that you can get some great cross-control action, including almost sideways flight, side-slips, and flat turns. With a little elevator input, we have even been able to knife edge the RASCAL FORTY very effectively.

Landing the RASCAL FORTY ARF is typically a pleasure. We suggest using a standard landing approach, beginning with a throttled back downwind leg and base turn to the final approach into the wind. During final approach, keep just a little power on the engine until the airplane is exactly where you want it for touchdown. In crosswind situations, a little rudder input will likely be needed to keep the airplane lined up with the runway. The RASCAL FORTY can be easily landed on either main wheels or in the three-point position. As long as we're on the subject, no landing gear system is bulletproof. Your RASCAL FORTY ARF has a great landing gear system that has proven to be very tough on both grass and asphalt flying fields. However, it can be ripped off during less than desirable landing approaches, poor field conditions, failure to flare, and just plain "brain fade". If this happens, simply epoxy the landing gear block back in place and learn to be more careful the next time. After landing, always remember to hold up elevator when taxiing to keep the tailwheel firmly to the ground.

We sincerely hope that your RASCAL FORTY ARF will provide you with many, many enjoyable flights. We also hope that this has been a pleasurable kit for you to assemble and fly. Please operate your airplane in a safe, responsible manner with constant regard to other flyers, spectators, and property.

# RASCAL FORTY ARF NOTES

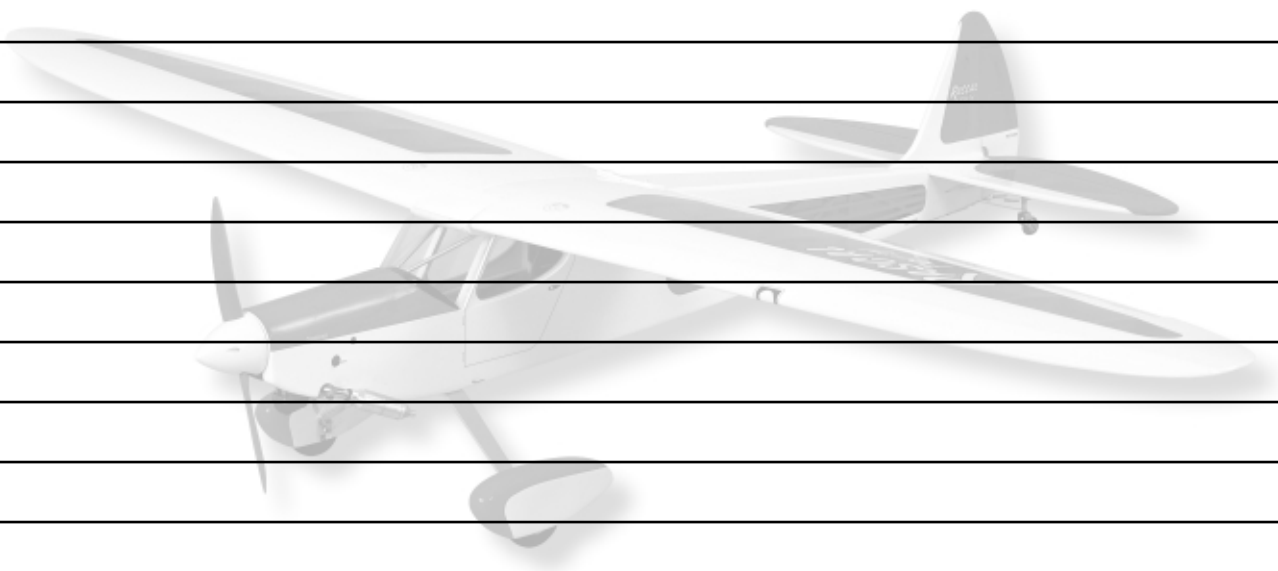

## **WARNING! THIS IS NOT A TOY!**

Flying machines of any form, either model-size or full-size, are not toys! Because of the speeds that airplanes must achieve in order to fly, they are capable of causing serious bodily harm and property damage if they crash. **IT IS YOUR RESPONSIBILITY AND YOURS ALONE** to assemble this model airplane correctly according to the plans and instructions, to ground test the finished model before each flight to make sure it is completely airworthy, and to always fly your model in a safe location and in a safe manner. The first test flights should only be made by an experienced R/C flyer, familiar with high performance R/C aircraft.

The governing body for radio-control model airplanes in the United States is the **ACADEMY OF MODEL AERONAUTICS**, commonly called the **AMA**. The **AMA SAFETY CODE** provides guidelines for the safe operation of R/C model airplanes. While AMA membership is not necessarily mandatory, it is required by most R/C flying clubs in the U.S. and provides you with important liability insurance in case your R/C model should ever cause serious property damage or personal injury to someone else. For more information, contact:

**ACADEMY OF MODEL AERONAUTICS**  
5161 East Memorial Drive  
Muncie, IN 47302  
Telephone: (765) 287-1256

**AMA WEB SITE: [www.modelaircraft.org](http://www.modelaircraft.org)**

## **CUSTOMER SERVICE**

SIG MANUFACTURING COMPANY, INC. is totally committed to your success in both assembling and flying the RASCAL FORTY ARF kit. Should you encounter any problem building this kit or discover any missing or damaged parts, please feel free to contact us by mail or telephone.

**SIG MANUFACTURING COMPANY, INC.**  
P.O. Box 520  
Montezuma, IA 50171-0520

**SIG MODELER'S ORDERLINE: 1-800-247-5008**  
(to order parts)

**SIG MODELER'S HOTLINE: 1-641-623-0215**  
(for technical support)

**SIG WEB SITE: [www.sigmfg.com](http://www.sigmfg.com)**

## **LIMIT OF LIABILITY**

The craftsmanship, attention to detail, and actions of the builder/flyer of this model airplane kit will ultimately determine the airworthiness, flight performance, and safety of the finished model. SIG MFG. CO.'s obligation shall be to replace those parts of the kit proven to be defective or missing. The user shall determine the suitability of the product for his or her intended use and shall assume all risk and liability in connection therewith.